



COMPONENTES PARA LA PULVERIZACIÓN E INDUSTRIA



TARIFA 2022

*“ El primer hombre fue un agricultor
y toda la nobleza histórica descansa
sobre la agricultura ”*

Ralph Waldo Emerson



Fundada en 1986, ofrece la más amplia y especializada gama en componentes de Pulverización para la Agricultura e Industria.

Siempre a la vanguardia de la tecnología más avanzada, gracias a la estrecha colaboración comercial y de nuevos desarrollos con nuestras representadas, fabricantes europeos líderes mundiales en innovación, calidad, investigación y prestaciones.

Nuestras modernas y amplias instalaciones junto a personal cualificado y de gran experiencia nos permiten asegurar una calidad de servicio de alto nivel.

Sobre nuestra base de organización, servicio, garantía, experiencia y nuestra gratitud a todos los clientes y colaboradores...nuestro compromiso de evolución, mejora y atención profesional personalizada.

NUEVAS NECESIDADES, NUEVAS TÉCNICAS... LA AGRICULTURA PERDURA COMO MOTOR DE EVOLUCIÓN.



INTERAGRI S.A.

Crta. N-230, Km. 5,6 - 25196 LLEIDA

TEL. 973 22 10 77 - 973 22 14 77

Apdo. de Correos 642 - 25080 LLEIDA

www.interagri.es interagri@interagri.es



PEDIDOS : ventas@interagri.es

CONSULTAS COMERCIALES/TÉCNICAS :
comercial@interagri.es / interagri@interagri.es

COMPRAS : compras@interagri.es

CONTABLE : control@interagri.es

FACTURACIÓN/ADMINISTRACIÓN : admin@interagri.es

GENERAL : info@interagri.es



INDEX 02.20

55 - 1



105 - 56



141 - 106



155 - 142



164 - 169



**CONTROL-
MEDICIÓN**

183 - 170



191 - 184

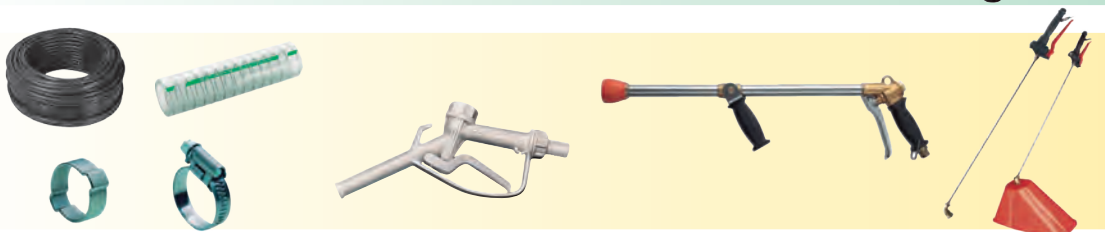

195 - 192





**MANDOS
ORDENADORES
GPS
MANÓMETROS-GRIFOS**

1 - 55



**GRIFOS
FILTROS
RACORERÍA**

56 - 105



**JETS ATOMIZADOR Y ACCESORIOS
JETS HERBICIDAS
BOQUILLAS**

106 - 141



**MEZCLADORES
HIDROCARGADORES
TAPAS
ACCESORIOS DEPÓSITOS**

142 - 155



**INCORPORADORES
MARCADORES DE ESPUMA
CASOTTI
ATV-INTERFILAS
DETERGENTE**

156 - 163



**BOMBAS
PISTÓN-MEMBRANA
AUTOASPIRANTES
CENTRÍFUGAS, 12 Vdc**

170 - 183



**PISTOLAS
LANZAS
MANGUERA**

184 - 191



**EQUIPOS SEGURIDAD
CASCOS**

192 - 195

NOVEDADES
CONSULTE DETALLES TECNICOS Y PRESUPUESTOS

IOTBOX - YCONNECT

Unidad de control y plataforma Ynova que permite monitorear, controlar y operar de forma remota múltiples equipos en tiempo real.

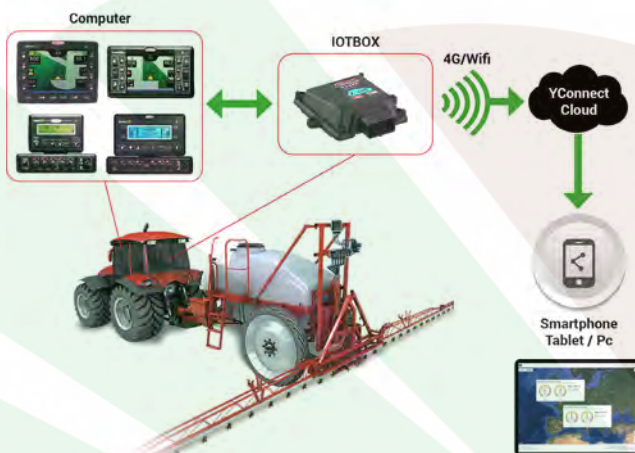

ISOBUS

HERBICIDA - ATOMIZADOR - MULTIHILERAS



ORION WR

DOBLE CAUDALIMETRO INTEGRADO
CON VALVULA DESVIADORA
AMPLIO RANGO DE MEDICION (0.3-100)
(0,5-200)



**PANELES AUXILIARES Y JOYSTICK
MULTIFUNCION**





GRUPO MANDO ELÉCTRICO HERBICIDAS



**CAJA DE MANDOS SERIE 4669
3 - 5 y 7 SECCIONES**

CABLES INTEGRADOS CON ROTACIÓN PARA FÁCIL POSICIONAMIENTO
SÓLO VÁLIDA PARA MOTORES 3 CABLES

**GRUPOS VÁLVULAS 863
(3 CABLES)**

120 - 150 l/mn - 20 bar

- * VÁLVULAS DE SECCIÓN CON RETORNOS COMPENSADOS (salidas d. 13)
- * VÁLVULA DE REGULACIÓN PROPORCIONAL
- * VÁLVULA GENERAL ON-OFF
- * VÁLVULA MANUAL DE MÁXIMA PRESIÓN
- * CODO SALIDA RETORNOS COMPENSADOS D. 25 INCLUIDO

CÓDIGO		DESCRIPCIÓN	P.V.P. €
3 VIAS	K4669 5333	CAJA MANDO 3 VÍAS CABLE ALIMENTACIÓN 2 m. Y CABLEADO VÁLVULAS 0,50 m + 3 m SECCIONABLE	256,00
	471 530 2 E0	GRUPO VÁLVULAS 3 SECCIONES	720,00
TOTAL MATERIALES			976,00

CÓDIGO		DESCRIPCIÓN	P.V.P. €
5 VIAS	K4669 5533	CAJA MANDO 5 VÍAS CABLE ALIMENTACIÓN 2 m. Y CABLEADO VÁLVULAS 0,50 m + 3 m SECCIONABLE	298,00
	471 550 2 E0	GRUPO VÁLVULAS 5 SECCIONES	980,00
TOTAL MATERIALES			1278,00

CÓDIGO		DESCRIPCIÓN	P.V.P. €
7 VIAS	K4669 5733	CAJA MANDO 7 VÍAS CABLE ALIMENTACIÓN 2 m. Y CABLEADO VÁLVULAS 0,50 m + 5 m SECCIONABLE	372,00
	471 570 2 E0	GRUPO VÁLVULAS 7 SECCIONES	1.240,00
TOTAL MATERIALES			1612,00

MANÓMETRO ADAPTABLE A CAJAS 4669

(incluido tubo rilsan 6 m y rácores conexión)



CÓDIGO	ESCALA	P.V.P. €
4668 12	0...25 - cl 2,5	44,29
4668 22	0...5/25 - isométrico-cl 1,6	88,06

DIGIBLOC 4668



CÓDIGO	DESCRIPCIÓN	P.V.P. €
4668 3B	PANTALLA DIGITAL. CABLE ALIMENTACIÓN 2 m y CABLE CONEXIÓN A TRASDUCTOR 3 m	131,84

SENSOR DE PRESIÓN



CÓDIGO	TIPO	P.V.P. €
466 113.200	0 - 20 bar	163,95



CONTROL BOX PARA BOQUILLAS FINAL DE BARRA SELETRON

designed for **seleTRON**



CAJA DE MANDO PARA ACCIONAMIENTO 1 ó 2 SELETRON FINAL DE BARRA DESDE CABINA
PERMITE LA APERTURA/CIERRE INDIVIDUAL DIRECTAMENTE DE LAS BOQUILLAS FINALES SIN PRESENCIA DE VÁLVULAS DE SECCIÓN
ADAPTABLES A TODO TIPO DE MÁQUINAS

INCLUIDOS:

- * CABLE ALIMENTACIÓN 2 M Y SALIDA PARA SELETRON 7 M.
 - * CABLE CONEXIÓN PARA 2 SELETRON 1 m. + 18/18 M (POS 29)
- PORTABOQUILLAS SELETRON POS. 20 Y BOQUILLAS A PEDIR POR SEPARADO**

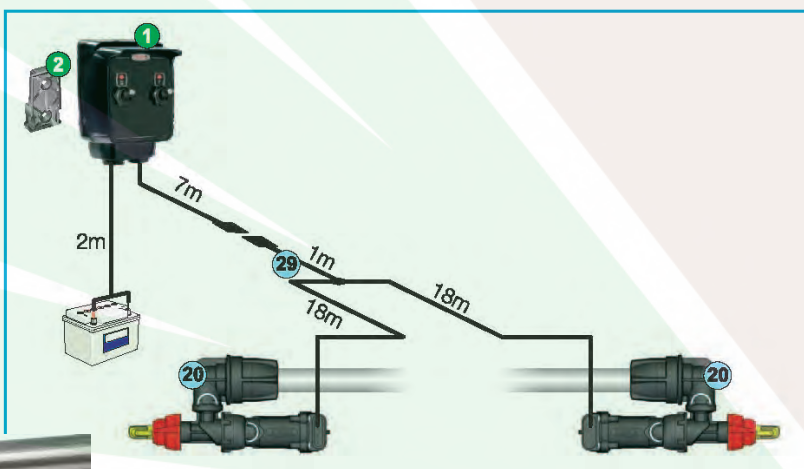

CÓDIGO	DESCRIPCIÓN	P.V.P. €
K 4668 52043	KIT CAJA Y CABLES	174,00
4065 T440	SELETRON ROSCA H 1/2"	101,85
4065 T840	SELETRON EASYFIT	

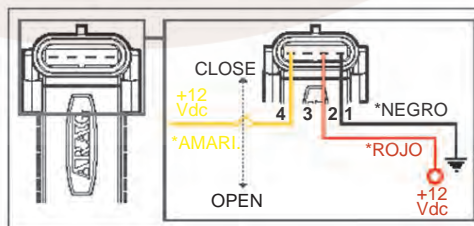



VÁLVULAS DE BOLA MOTORIZADAS COMPACTAS

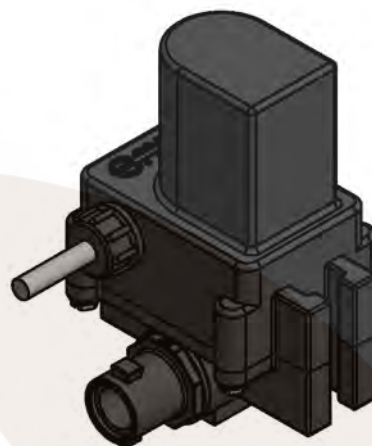
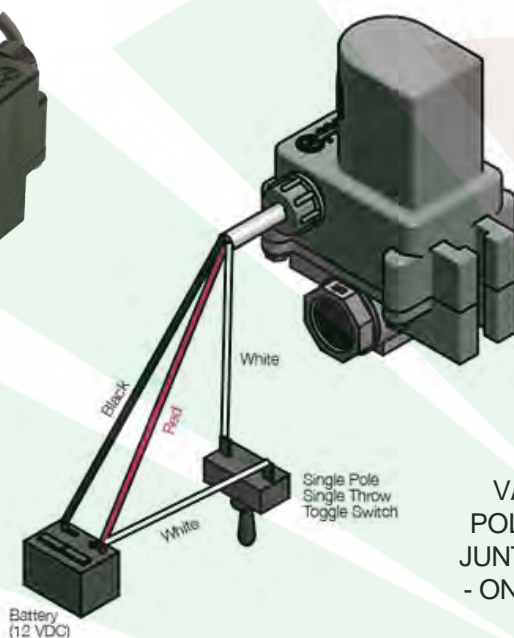

VÁLVULAS ELECTRICAS 12 V - BOLA POLIETILENO CON ASIENTOS EN TFM Y JUNTAS EPDM. CUERPO PP REFORZADO - ON/OFF 0,3 " SEG - MAX ABS. 0,75 AMP - PRESIÓN MAX. 20 BAR

CÓDIGO	DESCRIPCIÓN	P.V.P. €
LEV050000	VÁLVULA ON-OFF 1/2" HEMBRA	190,00
LEV038000	VÁLVULA ON-OFF 3/8" HEMBRA	
LEV038PLS	VÁLVULA ON-OFF - ENTRADA 3/8" HEMBRA - SALIDA ATAQUE RÁPIDO - IDEAL MONTAJE EXTREMOS BARRAS	

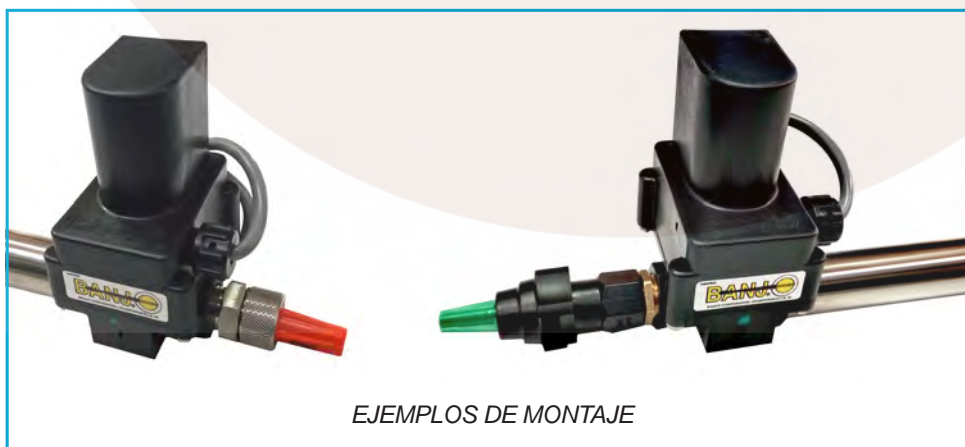



VISUALIZADOR MULTIFUNCION VISIO



- VISUALIZADOR DE MÚLTIPLES FUNCIONES SELECCIONABLES DESDE EL SOFTWARE
- PUERTO USB PARA TRANSFERENCIA DE DATOS
- DISPLAY RETROILUMINADO
- MONITOR RESISTENTE A LOS AGENTES ATMOSFÉRICOS
- RECEPCION DATOS DE 1 Ó 2 SENSORES
- MULTI LINGÜE Y DISTINTAS UNIDADES DE MEDIDA
- ALARMAS VISUALES Y SONORAS
- ALIMENTACION 12 Vdc

ALGUNAS APLICACIONES:

- * VELOCIDAD km/h + PRESIÓN
- * VOLUMEN - l/mn y 2 TOTALIZADORES
- * SUPERFICIE - km/h y ha 2 TOTALIZADORES
- * DOSIFICACION: km/h - l/mn - l/ha -TOTALES LIQUIDO Y SUPERFICIE
- * NIVEL Y PRESION:INDICADOR NIVEL DEPÓSITO + PRESION DE TRABAJO
- * CUENTAVUELTAS: R.P.M.



MONITOR CON CABLE ALIMENTACION Y CABLE PARA 2 SENSORES

CÓDIGO	P.V.P. €
K467 0610	299,00

SENSORES A PEDIR POR SEPARADO

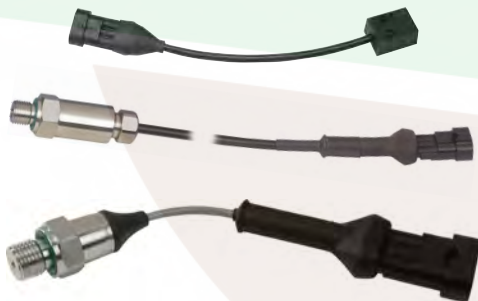

DESCRIPCIÓN	CARACTERISTICAS	CÓDIGO	P.V.P. €
SENSORES VELOCIDAD Y R.P.M. con cable 5 m	INDUCTIVO	467 100.086	95,02
SENSOR PRESION con cable 10 cm.	0-20 BAR	466 113.200	163,95
	0-50 BAR	466 113.500	
SENSOR NIVEL con cable 2 m	Señal 4 - 20 mA	466 113.004 1/4"	416,00
	Señal 4 - 20 mA	466 113.005 1/2"	495,00



CAUDALIMETROS
VER DISTINTOS MODELOS EN HOJA ESPECÍFICA

2022



CAJAS DE MANDO HIDRÁULICAS SERIE 4669



- * CAJA PARA CONTROL DEL MOVIMIENTO DE LAS BARRAS A TRAVÉS DE VÁLVULAS OLEODINÁMICAS DE DOBLE EFECTO.
- * MANDOS PARA NIVELACION, ALTURA, BLOQUEO Y 2, 4 o 6 MOVIMIENTOS DE BARRA
- * ALIMENTACION 12 Vdc
- * INCLUYEN: CABLE ALIMENTACION DE 2 M. Y CONECTOR PARA CABLEADO 0,50 cm.

CÓDIGO	VÍAS	P.V.P. €
4669 7020	2 + 3	180,25
4669 7040	4 + 3	213,21
4669 7060	6 + 3	244,11

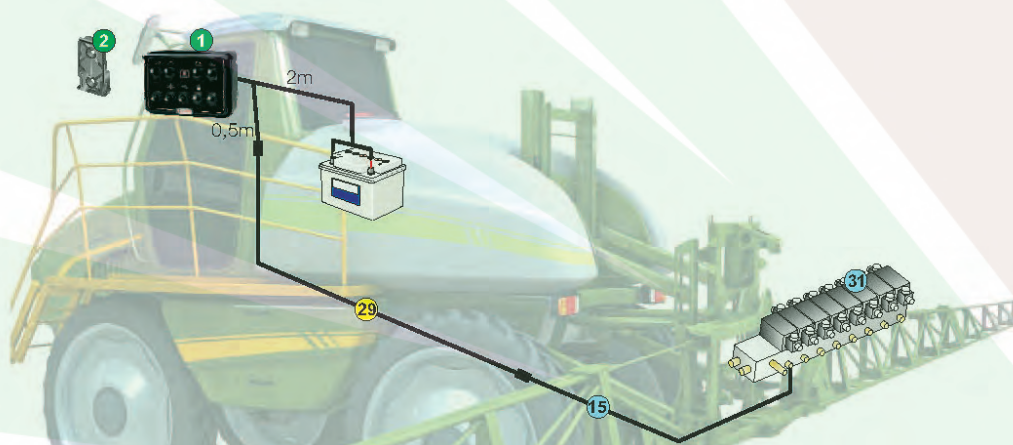

CABLEADOS PARA CONEXIÓN VÁLVULAS POS 15 - A PEDIR POR SEPARADO:

CÓDIGO	VÍAS	LARGO mts	P.V.P. €
4669 70504.100	2 + 3	6	145,34
4669 70505.100	2 + 3	10	177,17
4669 70704.100	4 + 3	6	189,90
4669 70904.100	6 + 3	6	255,97
4669 70905.100	6 + 3	10	285,38
467 32000.110	ALARGO (29)	3	114,58



**- GRUPOS ELECTROVÁLVULAS MODULARES -
-DISPONIBLES BAJO PEDIDO-
-SOLICITEN PRESUPUESTO-**



ORDENADORES PARA HERBICIDAS

BRAVO 180 S



COMPLETO DE CABLEADO Y SENSOR DE VELOCIDAD INDUCTIVO

CÓDIGO	VÍAS	P.V.P. €
467 180501	5	1.365,00
467 180701	7	1.694,00

COMPACTO-FUNCIONAL-ELEVADAS PRESTACIONES. COSTE EQUILIBRADO

- CONTROL AUTOMÁTICO DE LA DISTRIBUCIÓN
- PUERTO USB PARA TRANSFERENCIA DATOS Y ACTUALIZACIÓN SOFTWARE
- REGULACIÓN AUTOMÁTICA POR DETECCIÓN DE CAUDAL O PRESIÓN
- POSIBILIDAD DE TRABAJO EN MANUAL
- INDICADOR NIVEL CISTERNA INTEGRADO (SENSOR OPCIONAL)
- CIERRE AUTOMÁTICO POR DEBAJO DE PRESIÓN Y/O VELOCIDAD MÍNIMAS PROGRAMADAS
- INCREMENTO Y REDUCCIÓN MOMENTÁNEAS DE LA DOSIFICACIÓN PROGRAMADA
- 10 CONFIGURACIONES DE TRABAJOS MEMORIZABLES
- CALIBRACIÓN DE LA CISTERNA MEDIANTE SENSOR NIVEL OPCIONAL
- ALARMAS VISUALES Y SONORAS

DISPLAY RETROILUMINADO

DATOS QUE PUEDEN VISUALIZARSE:

- DOSIFICACIÓN - VELOCIDAD - PRESIÓN - CAUDAL - CANTIDAD DISTRIBUIDA - NIVEL CISTERNA - SUPERFICIE - DURACIÓN DEL TRATAMIENTO - DISTANCIA RECORRIDA.*

BRAVO 350 HERBICIDA



GAMA MEDIA-ALTA DE PRESTACIONES SIMILARES AL BRAVO 180S CON PANTALLA AMPLIADA DE MÚLTIPLES DATOS SIMULTANEAMENTE VISIBLES DISPONIBLE EN CONEXIÓN DIRECTA

COMPLETO DE CABLEADO
NO INCLUYE SENSOR DE VELOCIDAD

CÓDIGO	VÍAS	P.V.P. €
467 3507001	7	1.751,00

OTRAS VERSIONES CON FUNCIONES HIDRAULICAS BAJO PEDIDO

- GRUPO VÁLVULAS A PEDIR POR SEPARADO -
- ANTENA/SENSOR VELOCIDAD A PEDIR POR SEPARADO -



GRUPOS DE MANDO PARA BRAVO 180 S - 350 S - 400 S y DELTA

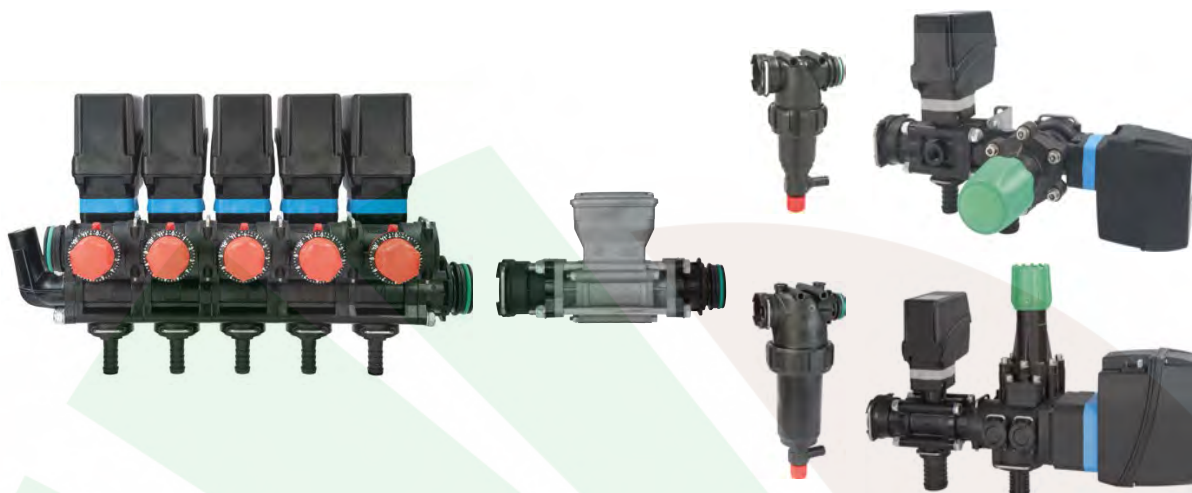

VÁLVULA GENERAL ON-OFF +
REGULADORA PRESIÓN PROPORCIONAL
+ FILTRO + CAUDALIMETRO ORION +
VÁLVULAS SECCION 863 CON RETORNO
COMPENSADO (codo T4 D. 25 incluido) -
ENLACES T5

CÓDIGO	VÍAS	L/mn MAX	P.V.P. €
K8715 520P50	5	100	1.700,00
K8717 520P50	7	100	1.975,00
K8717 520R50	7	150	1.975,00
K8647 52U50	7	200	2.305,00

SENSORES OPCIONALES PARA BRAVO 180 S Y 350 S

ATLAS 100



Cable 10 cm



DESCRIPCIÓN	CÓDIGO	P.V.P. €
SENSOR DE VELOCIDAD GPS *ALIMENTACION CONEXIÓN DIRECTA A BRAVO 180S/300S. Cable 5 m. incluido *CORRECCION DIFERENCIA SBAS *ACTUALIZACION DATOS 5 VECES POR SEGUNDO *FIJACIÓN MAGNETICA INCLUIDA *LED ESTADO DE FUNCIONAMIENTO	467 01652	324,64
CABLE VELOCIDAD TOMA STANDAR ISO11786 *PERMITE USAR LA TOMA DE RADAR DEL TRACTOR PARA LECTURA VELOCIDAD - longitud 5 m *CONEXION DIRECTA A MONITOR O A CABLEADO	467 180000.090 MONITOR	101,85
	467 100.091 CABLEADO	76,12
SENSOR DE PRESION 0 - 20 BAR	466 113.200	163,95
SENSOR DE PRESION 0 - 50 BAR	466 113.500	
SENSOR DE NIVEL DEPÓSITO PREVIA CALIBRACION VISUALIZA EN TIEMPO REAL LA CANTIDAD DE LÍQUIDO EN CISTERNA- cable 2 m	466 113 .004	416,00
SENSOR VELOCIDAD/RPM INDUCTIVO incluido en BRAVO 180S- cable 5 m	467 100.086	95,02



NAVEGADOR GPS

navigator LT

RECEPTOR GPS/GLONASS INTEGRADO COMPATIBLE CON SEÑALES DE CORRECCIÓN GRATUITAS SBAS (EGNOS, WAAS MSAS... ETC) - DISPLAY 5,7 " ALTA RESOLUCIÓN - LECTOR SD INTEGRADO (TRANSFERENCIA DATOS Y ACTUALIZACION SOFTWARE)



- * CÁLCULO AREA DE CAMPO
- * AVISO SONORO DE VIRAJE DE ACUERDO AL RADIO PROGRAMADO
- * FUNCION REALINEAMIENTO HILERAS
- * VISUALIZACION Nº DE LINEAS, DISTANCIA Y DIRECCION PARA RETORNO AL PUNTO DE INTERUPCION
- * PANTALLA DIURNA/NOCTURNA
- * ADAPTACION PANTALLA CONDUCCION AL NIVEL DE ZOOM ESCOGIDO
- * MEMORIZACION Y VISUALIZACIÓN DE PUNTOS DE INTERÉS
- * MODALIDADES DE CONDUCCION - PARALELA - CURVAV- PIVOT Y LIBRE
- * GESTION DE VARIOS USUARIOS, EQUIPOS Y TRACTORES
- * EXPORTACION TRABAJOS EN FORMATO SHAPE Y KML
- * TECNOLOGIA GL 1DE PARA REDUCIR DESVIACIONES SIN PRESENCIA SEÑAL DGPS
- * ANTENA MAGNETICA SENSIBILIDAD REDUCIDA A INTERFERENCIAS (0,5 dB) LNA
- * **CABLE HABILITACION TRATAMIENTO EXTERNO Y ENTRADA DIRECCION DE MARCHA (ADELANTE-ATRÁS) - OPCIONAL -**

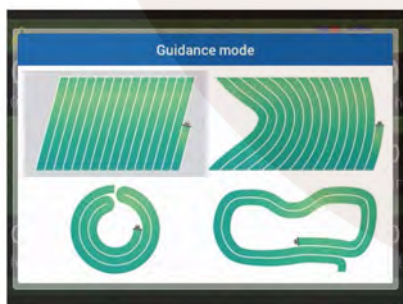

ACCESO A FUNCIONES INMEDIATO SIN IMPEDIR LA VISUALIZACION DE CONDUCCIÓN

CÓDIGO		P.V.P. €
467 4A1001	NAVIGATOR LT COMPLETO	2073,00
467 4A1000.110	CABLE AUXILIAR 3 m. Salida serial velocidad GPS-Habilitacion externa- DIRECCIÓN DE MARCHA	142,16
467 30000.090	CABLE HABILITACIÓN TRATAMIENTO	56,92



ORDENADOR PARA HERBICIDAS Y GUIADO GPS

bravo400sLT



**BRAVO 400S LT COMPACT
(CONEXIÓN DIRECTA SIN ECU EXTERNA)**

- * GESTION CIERRE AUTOMATICO DE SECCIONES - MAX. 7 + 7 HIDRAULICAS
- * PANTALLA 5,7" TFT DE ALTA RESOLUCIÓN
- * PROGRAMACION Y MANEJO INTUITIVOS
- * PUERTO USB Y LECTOR SD PARA TRANSFERENCIA DE DATOS Y SOFTWARE
- * MEMORIA INTERNA 2 GB
- * PREDISPUETO PARA CONEXIÓN A SISTEMA CONDUCCIÓN AUTOMÁTICA
- * GESTIÓN APLICACIÓN VARIABLE A TRAVES DE MAPAS DE PRESCRIPCIÓN.
- * PUEDE CONECTARSE A TODA LA GAMA DE ANTENAS GPS ARAG

SOLO PARA MANDOS CON VÁLVULAS 3 HILOS - SERIE 863-873



ATLAS300

VÍAS	CÓDIGO	P.V.P. €	CÓDIGO	P.V.P. €
	SIN ANTENA		ANTENA ATLAS 300*	
7	467 4L0701	2.675,00	K467 4L0701 1	3.665,00
7+7 HIDRAULICAS*	467 4L0713	3.289,00	K467 4L0713 1	4.280,00

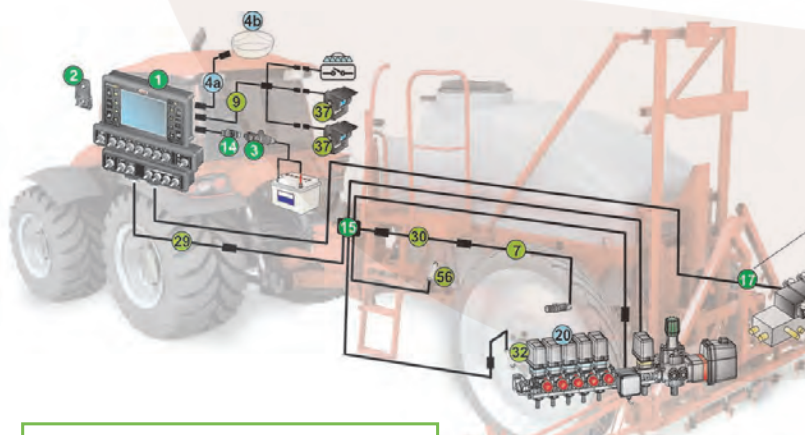

**(7)(9)(29)(30)(32)(37)(56)
SENSORES - ALARGOS -
TELECAMARAS -
ACCESORIOS A PEDIR POR
SEPARADO**

**(20) GRUPO DE MANDOS
PEDIR POR SEPARADO**



EL KIT COMPRENDE	
1	MONITOR
2	SOPORTE
3	CABLE TOMA CORRIENTE
4a	CABLE ANTENA*
4b	ANTENA ATLAS*
14	CABLE ALIMENTACION 6m
15	CABLE VÁLVULAS + SENSORES
17	CABLE VAL HIDRAULICAS-



ORDENADOR PARA HERCICIDAS Y GUIADO GPS

bravo400S



ibx100
SPRAYER

BRAVO 400S PARA BARRA DE SECCIONES
ORDENADOR DE ALTA PRECISIÓN CON SISTEMA DE NAVEGACION INTEGRADO PARA EL CONTROL AUTOMATICO DE LA DOSIS Y CONTROL DE SOBREPONICIONES PARAMETRIZABLE, CON CIERRE/APERTURA AUTOMATICO DE TRAMOS. MONITOR PARA USO EN SOLO GUIADO

- * PANTALLA 5.7" TFT DE ALTA RESOLUCIÓN
- * PROGRAMACION Y MANEJO INTUITIVOS
- * 2 puertos USB y lector SD para transferencia de datos y software
- * Memoria interna 2 GB para archivo trabajos, mapas, programaciones... etc.
- * Entrada para mando general externo y 2 telecamaras
- * **RECONOCIMIENTO SENTIDO DE MARCHA ATRÁS MEDIANTE CABLE OPCIONAL**



ATLAS 300



SMART 6L

VÍAS	CÓDIGO	P.V.P. €	CÓDIGO	P.V.P. €
	ANTENA ATLAS 300		ANTENA Smart 2 (L1+L2)*	
5	K467 4AP501AT	4.612,00	K467 4AP501SM	5.915,00
7	K467 4AP701AT	4.690,00	K467 4AP701SM	5.995,00
SECUENCIAL ...13	K467 4APD01AT	4.700,00	K467 4APD01SM	6.005,00

*SUBSCRIPCIÓN TERRASTAR L NO INCLUIDA

(20) GRUPO DE MANDOS PEDIR POR SEPARADO

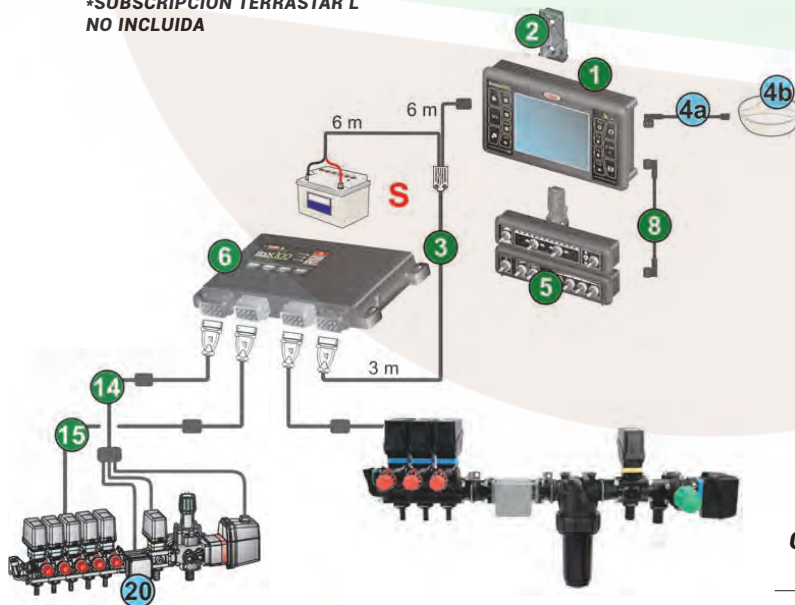

EL KIT COMPRENDE	
1	MONITOR
2	SOPORTE
3	CABLE AL Y UC
4a	CABLE ANTENA
4b	ANTENA
5	PANEL INTERRUPTORES
6	UNIDAD IBX
8	CABLE PANEL/MONITOR
14	CABLE SENSORES 3 m
15	CABLE VÁLVULAS 3 m

DISPONIBLES OTRAS CONFIGURACIONES CON MANDOS HIDRAULICOS, JOYSTICK... ETC

CONSULTE INFORMACION Y PRESUPUESTO



MONITOR DE APLICACIÓN Y GUIADO



ESPECIAL - A T V -



ORDENADOR DE APLICACION COMPACTO PARA USO EN EQUIPOS REDUCIDOS SIN CABINA HERMÉTICO CON ALETA PARASOL/TAPA CIERRE PROTECCION DISPLAY/BASE IMANES P/ ANTENA

- * MANDO JOYSTICK ERGONÓMICO MULTIFUNCIÓN
- * ANTENA ATLAS 300
- * COMPLETO DE CPU IBX100
- * CABLEADOS COMPLETOS (ALIMENTACION- VALVULAS - máx. 5 vías - CONEXIÓN ANTENA)

DISPONIBLE HASTA FIN DE EXISTENCIAS

CÓDIGO	P.V.P. €
K 467 0900	4.800,00

A PEDIR POR SEPARADO:



GRUPO VÁLVULAS

- * VALVULA GENERAL ON-OFF CON REGULADORA MANUAL DE MÁXIMA
- * REGULADORA PRESIÓN PROPORCIONAL
- * CAUDALIMETRO ELECTROMAGNETICO ORION
- * FILTRO * VALVULAS SECCION CON RETORNOS COMPENSADOS

CÓDIGO	VÍAS	P.V.P. €
K8715 320P50	3	1.428,00
K8715 520P50	5	1.700,00



BAJO PEDIDO DISPONIBLES CABLEADOS PARA CÁMARA Y CONDUCCION AUTOMÁTICA



ORDENADOR PARA HERCICIDAS Y GUIADO GPS

DELTA 80 PARA BARRA DE SECCIONES

- * GRAN DISPLAY DE 8,4" 800 X 600 PIXELS
- * AMPLIO TECLADO RETROILUMINADO DE MÁXIMA ERGONOMÍA
- * MEMORIA DATOS INTEGRADA 2 GB
- * 2 PUERTOS USB 2.0
- * 1 PUERTO ETHERNET 10/100 BASE T (RJ45)
- * WIFI INTEGRADO - WLAN 802.11 b/g/n
- * FUNCIONALIDADES DE COMUNICACION MÁXIMAS CON VERSION MODEM 3 G CUADRIBANDA (GPRS,EDGE, UMTS, HSPA) CON VELOCIDAD DE HASTA 21 Mbps
- * DOBLE ANTENA PARA MODEM: INTEGRADA Y EXTERNA CON BASE MAGNETICA



delta80

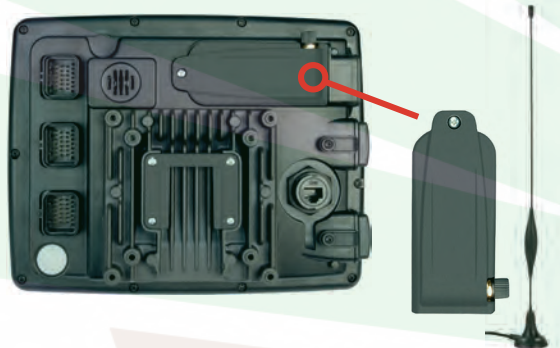

VERSION CON MODEM 3G

- PERMITE:
- * RECIBIR DATOS DE CORRECCIÓN RTK
 - * ENVIAR Y RECIBIR DATOS RELATIVOS A TRATAMIENTOS
 - * ANÁLISIS Y RESOLUCION INCIDENCIAS A DISTANCIA POR PARTE DE PERSONAL ESPECIALIZADO ARAG

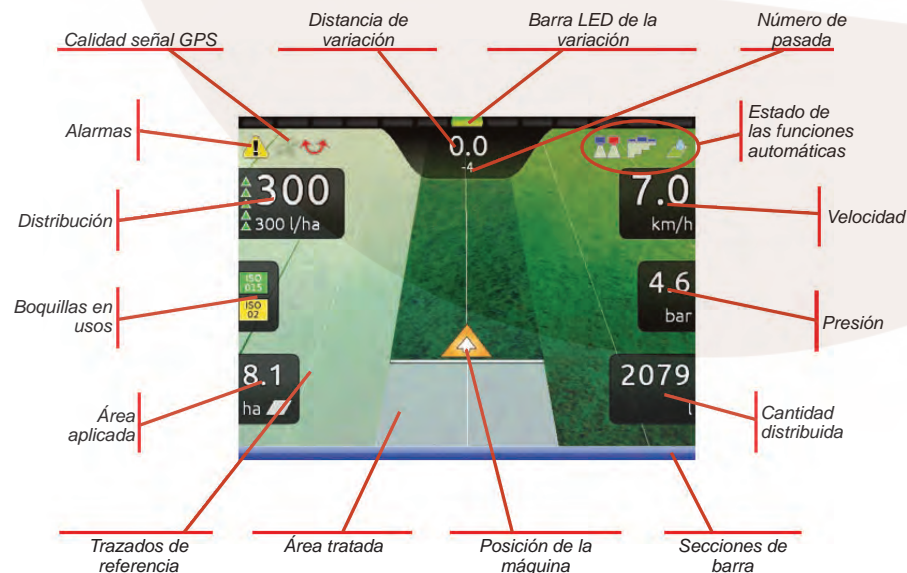

GESTION APLICACIÓN VARIABLE A TRAVÉS DE MAPAS EN FORMATO SHAPE

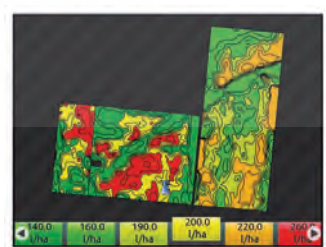

2022



ORDENADOR PARA HERBICIDAS Y GUIADO GPS

delta80 ibx100
SPRAYER

MONITOR COMPLETO

ANTENA Smart 6L - PANEL INTERRUPTORES - CPU IBX100 Y CABLEADOS

VÍAS	CÓDIGO	P.V.P. €	CÓDIGO	P.V.P. €
	SIN MODEM		CON MODEM 3 G	
7	K467 50P701 0	7.300,00	K467 50P701 1	7.900,00
SECUENCIAL ...13	K467 50PD01 0	7.425,00	K467 50PD01 1	8.040,00

Antena Smart 2: L1+L2 * SUBSCRIPCIÓN TERRASTAR L NO INCLUIDA* actualizable a Terrastar-C y RTK - Prec. 18 cm

EL KIT COMPRENDE	
1	MONITOR
2	SOPORTE
3	CABLE ALIMENTACION/IBX
4a	CABLE ANTENA
4b	ANTENA SMART 6L
5	PANEL INTERRUPTORES
6	UNIDAD IBX
8	CABLE PANEL/MONITOR
14	CABLE SENSORES 3 m
15	CABLE VÁLVULAS 3 m

(20) GRUPO DE MANDOS PEDIR POR SEPARADO

DISPONIBLES OTRAS CONFIGURACIONES CON MANDOS HIDRAULICOS , JOYSTICK... ETC

CONSULTE INFORMACION Y PRESUPUESTO



DELTA 80 T - TERMINAL VIRTUAL ISOBUS PANTALLA TÁCTIL



**MONITOR DE PANTALLA TACTIL
ISOBUS -TERMINAL VIRTUAL -
PANTALLA A COLOR, ERGONÓMICA CON
POSIBILIDAD DE CONECTARSE A LAS
REDES DE DATOS.**

*NAVEGACIÓN GPS *CIERRE AUTOMÁTICO
DE SECCIONES*APLICACIÓN
VARIABLE *GESTIÓN DE LA ACTIVIDAD
ISOXML*GESTIÓN DE DATOS RELEVANTES
DEL TRATAMIENTO*COMPATIBLE CON GUIA
AUTOMÁTICA POLARIS

***EMULACIÓN A OTRAS ECU DEL TRACTOR
PARA LA CORRECTA GESTIÓN DE OTROS
IMPLEMENTOS**

DISPLAY 8,4"

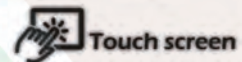

DESCRIPCIÓN	P.V.P. €
KIT ISOBUS COMPLETO CON PANTALLA DELTA 80T *IBX 100 POS 6 *CABLE GENERAL POS 3 *CABLE VIAS POS 15 - 7 VIAS *CABLE SENSORES + VÁLVULAS POS 14 *PANEL 7 SECCIONES POS 5a *PANTALLA TACTIL DELTA80T *ANTENA DOBLE FRECUENCIA SMART 6 L *GRUPO VÁLVULAS/MANDO - NO INCLUIDOS -	9.300,00

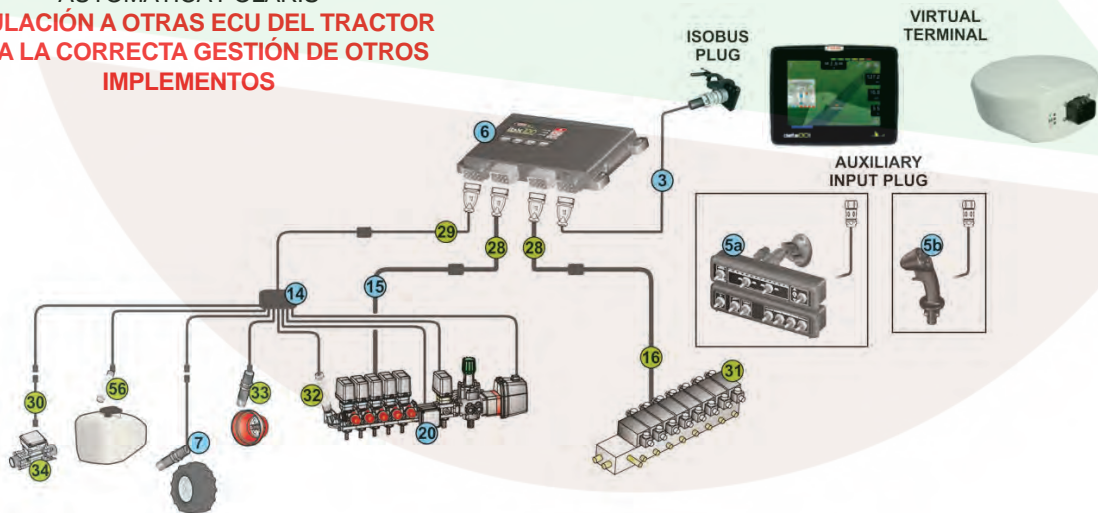

PARA OTRAS CONFIGURACIONES Y OPCIONES SOLICITEN PRESUPUESTO



ISOBUS



ibx100 ISOBUS
XXX SPRAYER

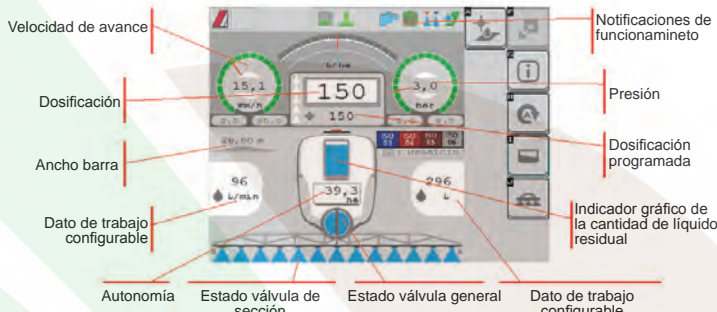

IBX 100 SPRAYER ISOBUS

CENTRAL MULTIPLATAFORMA QUE ALOJA EL SOFTWARE Y GESTION DE LAS APLICACIONES Y AL ESTAR CONECTADA A UN TRACTOR ISOBUS PERMITE GESTIONAR LA APLICACIÓN CON BARRAS DEL EQUIPO DE TRATAMIENTOS.

- * LEDS DE ESTADO DE FUNCIONAMIENTO
- * CONECTORES HERMÉTICOS CONEXION BAYONETA
- * CARCASA DE ALUMINIO DE ALTA RESISTENCIA
- * CONTROL DE HASTA 13 SECCIONES DE LÍQUIDO Y HASTA 9 FUNCIONES HIDRÁULICAS.
- * EN UNA UNICA PANTALLA DEL TERMINAL VIRTUAL SE VISUALIZAN LOS PARÁMETROS PRINCIPALES DE PULVERIZACIÓN.

KIT BÁSICO ISOBUS - EJEMPLO -

- * IBX 100 POS 6 - * CABLE GENERAL POS 3 - * CABLE VIAS POS 15 - * CABLE SENSORES + VÁLVULAS POS 14

P.V.P. €	P.V.P. €
5 vías	7 vías
1.745,00	1.771,00
P.V.P. €	P.V.P. €
9 vías	13 vías
1.792,00	1.834,00

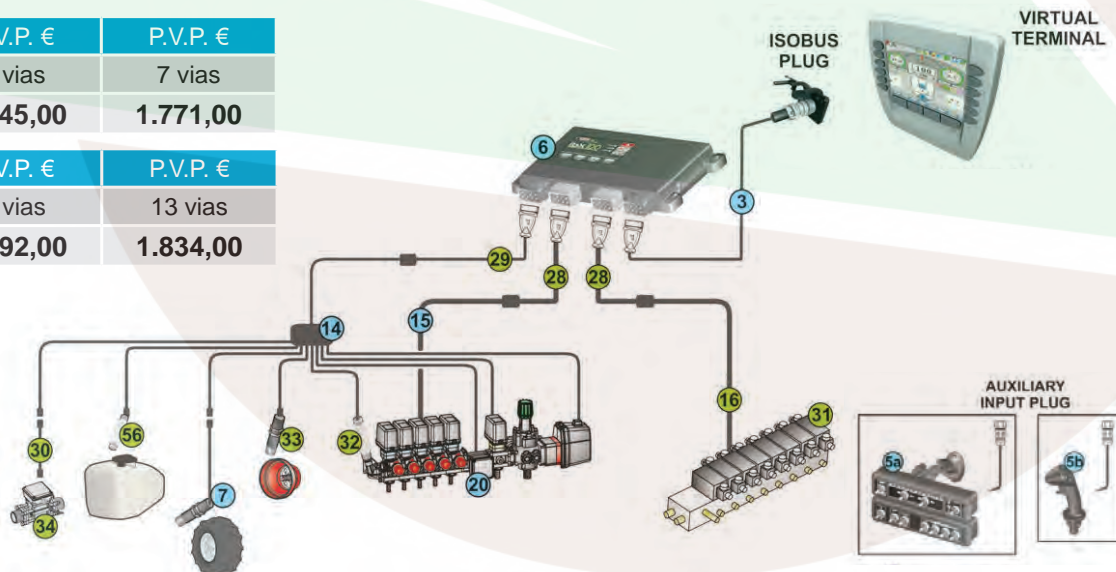

OPCIONALES aconsejables:	CÓDIGO	P.V.P. €
PANEL INTERRUPTORES 7 VÍAS pos 5a	468 1700	661,00
PANEL INTERRUPTORES 13 VÍAS secuencial pos 5a	468 1D1	595,00
JOYSTICK pos 5b	467 01802	747,00

PARA OTRAS CONFIGURACIONES Y OPCIONES SOLICITEN PRESUPUESTO



ORDENADORES ALTA PRECISION

seleTRON

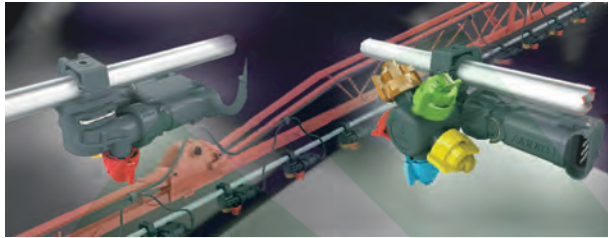

EL MÁXIMO EXPONENTE PARA AGRICULTURA DE PRECISIÓN

- * SISTEMA DE CONTROL SOBRE CADA BOQUILLA
- * **PERMITE AJUSTAR LA MÁXIMA PRECISIÓN DEL CONTROL DE GUIADO, ACTUANDO SOBRE CADA PUNTO DE PULVERIZACIÓN MEDIANTE EL CONTROL DE CIERRE/APERTURA DE CADA BOQUILLA, HASTA 104 UNIDADES.**
- * APLICACION DE DOSIS PROGRAMADA Y VARIABLE SEGÚN MAPEADOS CON SELECCION DE BOQUILLA MAS ADECUADA CON PORTAGET MULTIPLE.

MONTAJE CON MONITORES DELTA 80 Y BRAVO 400S

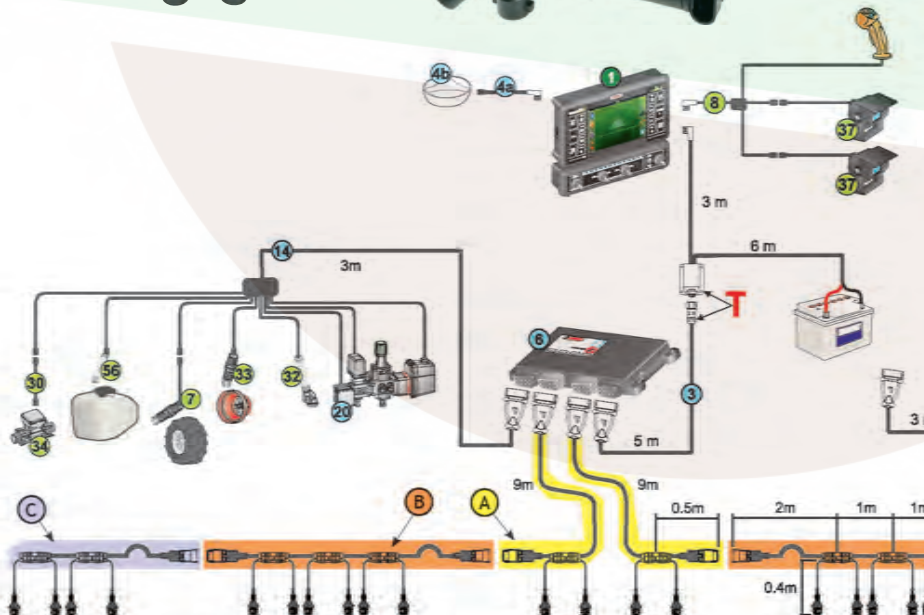
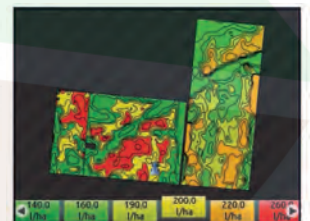

SOLICITE PRESUPUESTO DETALLADO SEGUN MEDIDA Y CONFIGURACION DE BARRAS

*UN ÚNICO CABLE DE ALIMENTACIÓN
*CABLEADOS EN LÍNEA ROBUSTOS DE SIMPLE INSTALACION

2022



SISTEMA DE CONDUCCIÓN AUTOMÁTICA



CONDUCCION ASISTIDA PARA BRAVO 400 S - DELTA 80 - DELTA 80T

- * REDUCE AREAS NO TRATADAS Y SOBREPOSICIONES
- * OPTIMIZA TIEMPO, COMBUSTIBLE Y PRODUCTO QUÍMICO
- * REDUCE LA FATIGA DEL OPERADOR



VOLANTE ILUSTRATIVO - NO INCLUIDO -

UNIDAD DE CONTROL POLARIS (ECU)

- * CALIBRACION AUTÓMATICA CON SIMPLES MANIOBRAS
- * ALTA VELOCIDAD DE APROXIMACION A LINEA DE REFERENCIA Y MANTENIMIENTO DE LA TRAYECTORIA SIN OSCILACIONES
- * ENTRADA AUXILIAR PARA PULSADOR O PEDAL ACTIVACION
- * SENSORES INERCIALES DE ALTA PRECISIÓN PARA COMPENSAR ERRORES DEBIDOS A LA INCLINACION DEL VEHICULO Y GPS
- * PERMITE MANEJAR EL MOTOR MDU 4
- * ENTRADA DE SEGURIDAD PARA SENSOR DE PRESENCIA OPERADOR
- * CABLEADOS DE CONEXION PARA BRAVO 400 S Y DELTA 80
- * POSIBILIDAD DE PROGRAMACIÓN Y MANTENIMIENTO MEDIANTE EL MONITOR ARAG

MOTOR ELECTRICO MDU-4

- * TRANSMISION DE ENGRANAJES SIN PATINAMIENTOS
- * NO OBSTACULIZA LA CONDUCCION MANUAL
- * SENSOR DE PAR QUE DESACTIVA LA CONDUCCION AUTOMATICA
- * INTERRUPTOR DE ENCENDIDO PARA INHABILITAR COMPLETAMENTE EL SISTEMA EN RECORRIDOS POR CARRETERA
- * REDUCIDO RUIDO DE ACCIONAMIENTO
- * NO NECESITA LA EXTRACCIÓN Y/O SUSTITUCIÓN DEL VOLANTE
- * FACIL Y RAPIDAMENTE TRANSFERIBLE DE UNO A OTRO VEHÍCULO
- * KITS DE ACOPLÉ ESPECÍFICOS DISPONIBLES PARA LOS TRACTORES MÁS COMUNES (A PEDIR POR SEPARADO)

bravo400S

delta80

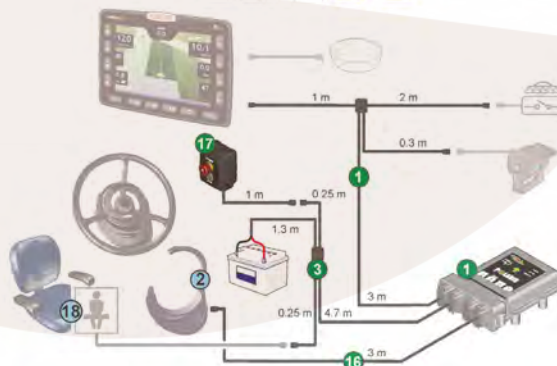
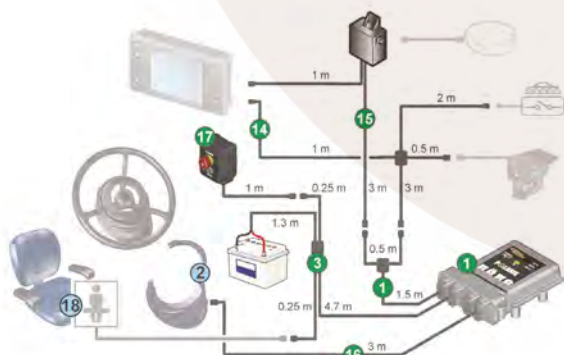

KIT COMPLETO POLARIS + MDU-4 + CABLEADOS

NO INCLUYE SENSOR PRESENCIA pos 18

P.V.P. €

7.521,00

MONITOR Y ANTENA NO INCLUIDOS - NECESITA ANTENA DOBLE FRECUENCIA (L1 + L2)



RECEPTORES / ANTENAS GPS

SENSOR VELOCIDAD GPS

ATLAS100



- * PUEDE MONTARSE EN ALTERNATIVA AL SENSOR DE VELOCIDAD DE RUEDA, FACILITANDO LA INSTALACION Y POLIVALENCIA A DISTINTOS VEHÍCULOS.
- * DOS TIPOS DE SEÑAL DE SALIDA
- * PUERTO SERIAL SEÑAL DE VELOCIDAD Y GPS TRACKING PARA CONEXION DIRECTA A BRAVO 300S/180S
- * SEÑAL DE FRECUENCIA PROPORCIONAL A LA VELOCIDAD
- * ACTUALIZACION DE DATOS 5 VECES POR SEGUNDO- LED ESTADO FUNCIONAMIENTO - CABLE CONEXION 5 M INCLUIDO - FIJACION POR IMANES INTEGRADAS -

CÓDIGO	467 01651	467 01652
VELOCIDAD	si	si
GPS TRACKING	no	si
SEÑAL FRECUENCIA	si	no
BRAVO 300S/180S	no	si
P.V.P. €	270,53	324,64



ANTENA GPS APTA PARA NAVEGACION VISUAL Y APLICACIÓN VARIABLE

ATLAS300



- * TECNOLOGIA GL1DE, REDUCE DESVIACIONES RAPIDAS DE TRAYECTORIA E INCREMENTA LA PRECISION ENTRE PASADAS
- * CALCULO POSICION SEÑALES GPS Y GLONASS
- * COMPATIBLE CON SEÑALES GRATUITAS SBAS(EGNOS, WAAS, MSAS...)
- * LED ESTADO FUNCIONAMIENTO
- * ACTUALIZACION POSICION 10 VECES POR SEGUNDO (10 HZ)
- * PRECONFIGURADO PARA CONEXION A MONITORES ARAG- - CABLE CONEXION A PEDIR POR SEPARADO -

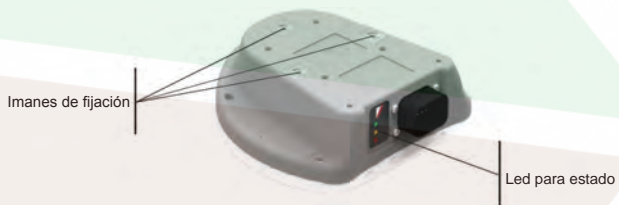

CÓDIGO	P.V.P. €
467 01650	893,00

CÓDIGO		P.V.P. €
467 01600.100	CABLE ANTENA B400S	95,55
467 5000.120	CABLE ANTENA DELTA 80	121,58

2022



RECEPTORES / ANTENAS GPS



INCLINÓMETRO INTEGRADO SEGUN MODELOS

- * TECNOLOGIA **GL1DE** PARA REDUCIR DESVIACIONES Y MANTENER LA PRECISIÓN ENTRE PASADAS, AÚN SIN SEÑAL DGPS
- * LED DE ESTADO DE FUNCIONAMIENTO
- * ACTUALIZACION POSICION 10 Hz
- * IMANES DE FIJACION INTEGRADOS
- * PRECONFIGURADAS PARA CONEXION A MONITORES **ARAG**
- * **TERRASTAR** ES UNA EMPRESA PRIVADA QUE PROPORCIONA SEÑALES DE CORRECCIÓN DIFERENCIAL EN TODO EL MUNDO VIA SATÉLITE. EL SERVICIO ES DE PAGO Y DEPENDE DEL NIVEL DE PRECISIÓN Y TIEMPO DE USO.



CÓDIGO	467 01650	467 01606	467 01609	467 01610	467 01607	467 01623	
MODELO	ATLAS 300	SMART 2	SMART 2 DOUBLE FREQUENCY	SMART 2 TERRASTAR-C PRO	SMART 2T INCLINOMETER	SMART 2T INCLINOMETER + DOUBLE FREQUENCY	
P.V.P. €	893,00	1.461,00	2.197,00	4.837,00	2.175,00	3.070,00	
⁽³⁾ Corrección libre	SBAS	SBAS	SBAS	SBAS	SBAS	SBAS	
⁽¹⁾⁽⁴⁾ Precisión P2P	50 cm	28 cm	18 cm	18 cm	28 cm	18 cm	
⁽²⁾⁽⁴⁾ Precisión H24	1,5 m	1,5 m	1,5 m	1,5 m	1,5 m	1,5 m	
Corrección de pago	-	-	TerraStar-L	TerraStar-L	TerraStar-C Pro	-	TerraStar-L
⁽¹⁾⁽⁴⁾ Precisión P2P	-	-	15 cm	15 cm	2,5 cm	-	15 cm
⁽²⁾⁽⁴⁾ Precisión H24	-	-	50 m	50 m	2,5 m	-	50 m
Cód. abono corrección 12 meses	-	-	ESW039TerraStar-L	- ESW039TerraStar-L - ESW010 TerraStar-C PRO	-	-	ESW039 TerraStar-L
Frecuencias de constelación	Única	Única	Doble	Doble	Única	Doble	
Inclinómetro	-	-	-	-	✓	✓	
Nº de canales de recepción	14	167	167	167	167	167	
Cód. licencia por actualización	-	- ESW030 Double freq. - ESW031 TerraStar-C PRO	ESW041 TerraStar-C PRO	-	- ESW032 Double freq. - ESW033 TerraStar-C	-	
	✓	✓	✓	✓	✓	✓	
	✓	✓	✓	✓	✓	✓	
	no recomendado	no recomendado	✓	✓	no recomendado	✓	
	-	-	✓	✓	-	✓	

- CABLE CONEXION A PEDIR POR SEPARADO -

CÓD.	SUSCRIPCIONES	P.V.P. €	CÓDIGO	P.V.P. €
ESW039	TERRASTAR-L 12 MESES	304,88	467 01600.100	CABLE ANTENA B400S 95,55
ESW040	TERRASTAR-C PRO 12 MESES	878,00	467 5000.120	CABLE ANTENA DELTA 80 121,58

(1) PRECISIÓN ENTRE PASADA Y PASADA: ERROR ENTRE UNA PASADA RECTILÍNEA Y SUCESIVA, REALIZADAS DENTRO DE LOS 15 MINUTOS

(2) PRECISIÓN ABSOLUTA: ERROR DE MEDIDA SOBRE UN PUNTO DETERMINADO 24 HORAS AL DÍA

(3) SIN LA CORRECCIÓN SBAS EL VALOR DE PRECISIÓN DE H24 PODRÍA LLEGAR A 5M

(4) ESPECIFICACIONES DE RENDIMIENTO SUJETAS A LAS CARACTERÍSTICAS DEL GNSS, LA DEGRADACIÓN DE LA SEÑAL OPERACIONAL EN EL ESPACIO (SIS), LAS CONDICIONES IONOSFÉRICAS Y TROPÓSFERICAS, LA GEOMETRÍA DEL SATÉLITE, LA LONGITUD DE LA LÍNEA DE BASE, LOS EFECTOS DE TRAYECTOS MÚLTIPLES Y LA PRESENCIA DE FUENTES DE INTERFERENCIA INTENCIONALES O NO INTENCIONALES

2022



ACCESORIOS PARA ORDENADORES



BlueCannon

- * FOCO CON HAZ DE LUZ ESPECIALMENTE DISEÑADO PARA ILUMINAR EL CHORRO DE LIQUIDO DE LAS BOQUILLAS.
- * PERMITE CONTROLAR SU CORRECTO FUNCIONAMIENTO INCLUSO EN HORAS NOCTURNAS.
- * UN SOLO FOCO POR LADO PERMITE ILUMINAR UNA BARRA DE 24 M .
- * CONECTOR HERMETICO INTEGRADO
- * CARCASA DE ALUMINIO Y LENTES DE MATERIAL PLÁSTICO
- * SOPORTE DIRECCIONABLE Y CONECTOR PARA CABLEADO

CÓDIGO	LUMEN EFECTIVOS	Nº LED	TENSION ALIMENTACION	CONSUMO			P.V.P.€
467 001 08	450	6	9 ÷ 36 Vdc	12 V	24 V	W	144,28
				1,5 A	975 A	18	

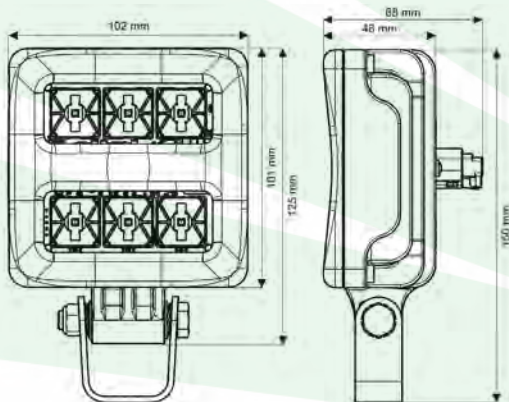

CÓDIGO		P.V.P.€
46700108.110	CABLE ALIMENTACION BLUE CANNON - A PEDIR POR SEPARADO	23,30

VISIO DIAGNOSTIC

- * MONITOR HERRAMIENTA PARA DIAGNOSTICO Y ACTUALIZACION DE TODOS LOS DISPOSITIVOS ARAG CANBUS (IBX100 - EXPLORER- VÁLVULAS 853 - SELETRON..ETC)
- * SUMINISTRADO EN KIT CON CABLES ADAPTADORES Y MALETIN ANTICHOQUE.



CÓDIGO	P.V.P.€
467 00301	780,00



Ejemplo de collegamento per apparecchio IBX100 ad Explorer. Mostra i connettori su adatta IBX100 ad Explorer. Esempio di connettore per attuatore SELETRON. Copyright Interagri



ACCESORIOS PARA ORDENADORES



JOSTICK

PERMITE CONTROLAR DIRECTAMENTE TODAS LAS FUNCIONES PRINCIPALES (PULVERIZACIÓN E HIDRÁULICA) SOBRE UN SÓLIDO ANCLAJE Y PERFECTO CONTROL DE MANIOBRAS.

- * TRANSMISION DE VIBRACION PARA MENSAJES AL OPERADOR
- * 15 TECLAS PARA CONTROL DE HASTA 39 FUNCIONES
- * 4 LEDS DE ESTADO
- * TECLADO DE GOMA RETROILUMINADO
- * MONTAJE CON ABRAZADERA D.27 O ROSCADO M10
- * IP65 TOTALMENTE ESTANCO
- * CABLE CONEXION A ORDENADOR DE 80 cm

CÓDIGO	P.V.P. €
467 01801	613,00

CÁMARA

PERMITE CONECTADA A ORDENADORES BRAVO 400S Y DELTA 80 LA VISIÓN DE PUNTOS FUERA DEL CAMPO VISUAL DEL OPERADOR

- * ILUMINACION CON INFRARROJOS PARA VISION NOCTURNA
- * VISION DIRECTA O ESPECULAR - ANGULAR 120º
- * SENSOR CCD A COLORES DE 1/3" 512X582 PIXEL
- * CABLE CONEXION 15 MTS.



CÓDIGO	P.V.P. €
467 00100	303,00



SOPORTES VENTOSA PARA ORDENADORES BRAVO

- * ALTA FIJACIÓN * ANTIVIBRACIONES
- * DOBLE UNIÓN ESFERICA PARA CUALQUIER POSICIÓN

	CÓDIGO	P.V.P. €
SIMPLE	467 040.650	80,29
TRIPLE	467 040.660	128,24

CABLES CONEXIÓN CÁMARA A MONITORES - A PEDIR POR SEPARADO-

	Nº CÁMARAS CONECTABLES	CÓDIGO	P.V.P. €
BRAVO 400 S	1 - 0,5 m	467 40000.090	74,26
	2 - 1,5 m	467 40000.091	127,31
DELTA 80	2 - 1,5 m	467 5000.115*	154,75

* INCLUYE CABLE MANDO GENERAL EXTERNO Y CABLE INDICADOR SENTIDO DE MARCHA

TOMAS ENCHUFES ALIMENTACIÓN

	CÓDIGO	P.V.P. €
3 POLOS	466 001	24,35
2 POLOS	466 111	20,78





CONTROL NIVELACION DE BARRAS

BLC embedded

- * BLC EN UNA NUEVA FUNCIONALIDAD PARA IBX-HYDRAULIC QUE MEDIANTE SENSORES DE ULTRASONIDOS CONTROLA LA INCLINACION DE LA BARRA Y PERMITE MANTENER UNA DISTANCIA UNIFORME Y PARALELA AL SUELO TANTO EN TERRENO LLANO COMO EN LADERAS.
- * ELEVADA PRECISION Y RAPIDEZ DE RESPUESTA
- * UTILIZA ELECTROVÁLVULAS HIDRAULICAS STANDAR
- * ADAPTABLE A SISTEMAS EXISTENTES



delta30 bravo400s

ISOBUS

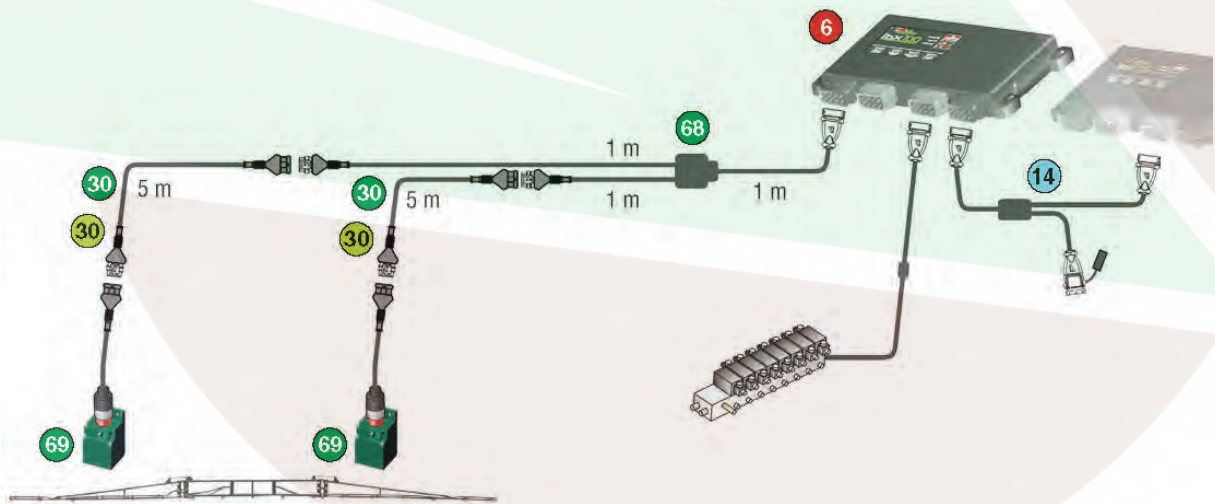
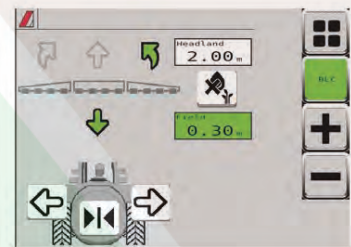

CÓDIGO	DESCRIPCION	P.V.P.€
467 9003.600	KIT POS 68+ (2)69+(2)30	1.929,00
467 9003	IBX HYDRAULIC P/ DELTA/B400S POS. 6	757,00
467 9005	IBX HYDRAULIC ISOBUS POS. 6	1.083,00
467 9002.120	CABLE POS.14 A IBX100 SPRAYER	116,87

2022



CONTROL NIVELACION DE BARRAS



- * BLC EN UNA NUEVA FUNCIONALIDAD PARA IBX-HYDRAULIC QUE MEDIANTE SENSORES DE ULTRASONIDOS CONTROLA LA INCLINACION DE LA BARRA Y PERMITE MANTENER UNA DISTANCIA UNIFORME Y PARALELA AL SUELO TANTO EN TERRENO LLANO COMO EN LADERAS.
- * ELEVADA PRECISION Y RAPIDEZ DE RESPUESTA
- * UTILIZA ELECTROVÁLVULAS HIDRAULICAS STANDAR
- * SISTEMA AUTONOMO INDEPENDIENTE DE OTROS CONTROLES DE PULVERIZACION



VISIO
BOOM LEVELING CONTROL **BLC**

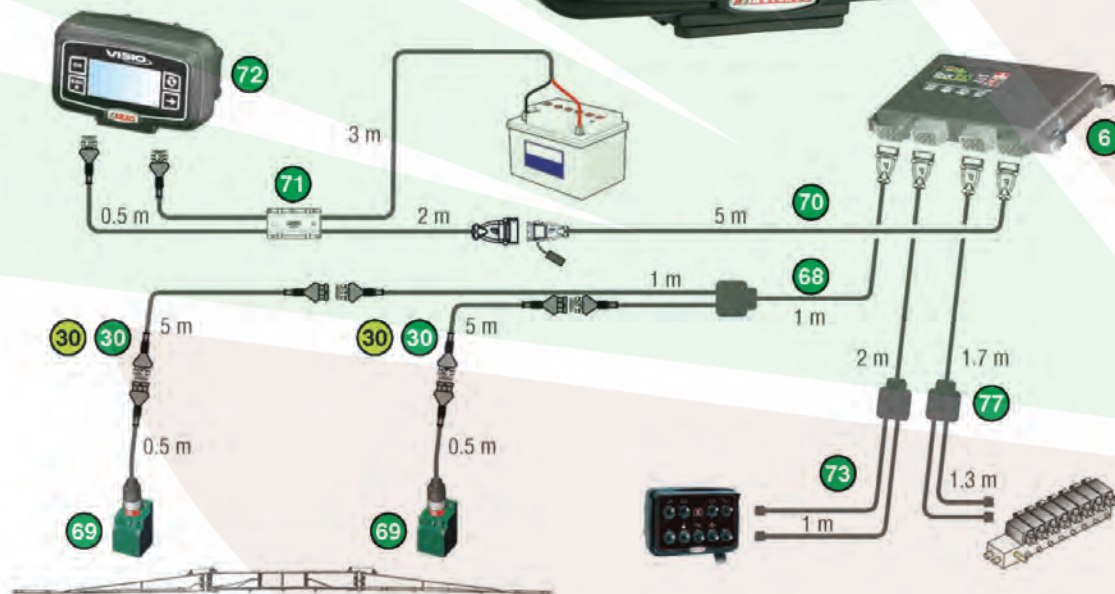

CÓDIGO	DESCRIPCION	P.V.P.€
467 0612	KIT POS: 6+ (2)30 + 68 + (2)69+ 70 + 71 + 72 + 73 + 77	3.376,00



DESCRIPCIÓN	CÓDIGO	P.V.P.€
KIT 2 SENSORES OPCIONALES PERMITE MEJORAR LA PRECISION EN CASO DE TERRENO NO UNIFORMES O CON RESIDUOS DE CULTIVOS. Incluye cable largo de 5 m	467 9003.601	1.550,00



VISUALIZADOR MULTI-CAUDAL



VISIO MULTIFLOW

VERSION ESPECÍFICA PARA CONEXIÓN A CAUDALÍMETRO MULTI CANAL

- * LECTURA DATOS SIMULTÁNEA DE HASTA 4 CAUDALÍMETROS MULTIFLOW -TOTAL 16 CANALES
- * ALARMAS VISUALES Y SONORAS
- * PUERTO USB PARA TRANSFERENCIA DE DATOS Y ACTUALIZACIÓN SOFTWARE
- * PANTALLA GRÁFICA RETROILUMINADA
- * RESISTENTE A LOS AGENTES ATMOSFÉRICOS
- * SOFTWARE MULTILINGÜE - DISTINTAS UNIDADES DE MEDIDA - PROGAMABLE Nº CAUDALÍMETROS CONECTADOS
- * PERMITE INSTALAR LOS CAUDALÍMETROS EN EL MEJOR PUNTO DEL SISTEMA, AUNQUE NO SEAN VISIBLES AL OPERADOR



CAUDALÍMETRO ELECTROMAGNÉTICO MÚLTIPLE - 4 CANALES -

DISEÑADO PARA LOS SISTEMAS DE DISTRIBUCIÓN DE ABONO LÍQUIDO EN SEMBRADORAS INDEPENDIENTE DE LA VISCOSIDAD DEL LÍQUIDO - SIN PARTES EN MOVIMIENTO

- * CAUDAL POR CANAL 0-3 - 6,0 L/MN (ERROR TÍPICO 0,5 % FONDO DE ESCALA)
- * PRESION HASTA 20 BAR
- * PUERTO A-NET PARA LECTURA CAUDAL Y CONFIGURACIÓN
- * LEDS SEÑALIZACION ESTADO DEL CANAL
- * CONEXIONES T1 Y COLECTOR MODULAR CONFIGURABLES
- * SISTEMA DE FIJACIÓN INTEGRADO CON 4 TORNILLOS M8 (O 5/16 UNE)



EJEMPLO DE MONTAJE

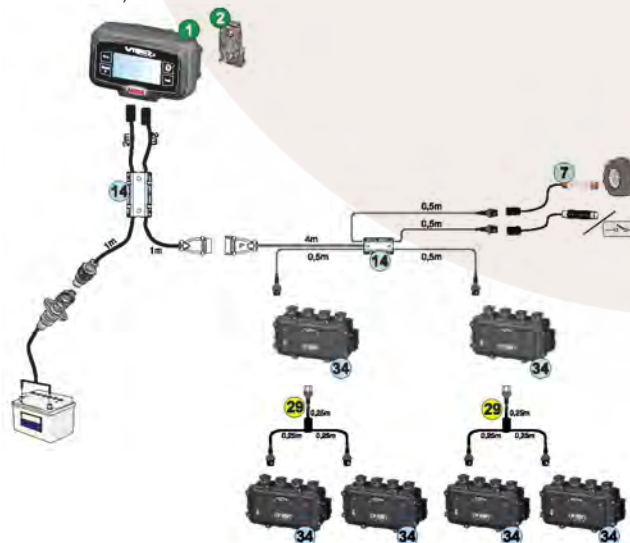

POS	CÓDIGO	P.V.P. €
1 - 2	467 0611	239,69
14	467 0611.510	203,69
7	467 100.086	95,02
29	467 49000.160	25,10
34	462 5AAGB1B1	1.226,00



ACCESORIOS CONEXIÓN

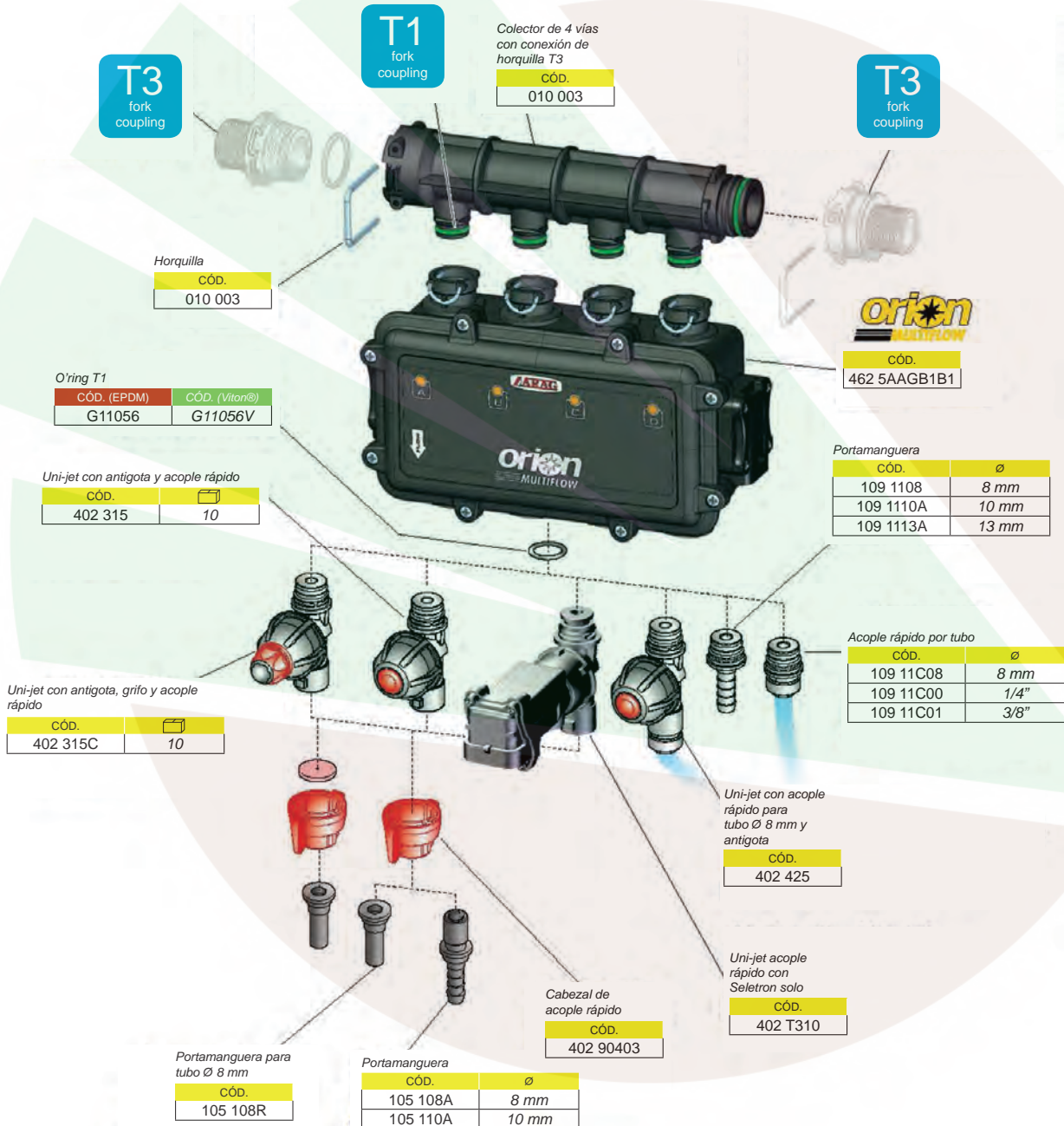

2022



CAUDALÍMETROS ELECTROMAGNETICOS *orion*

20 bar



40 bar

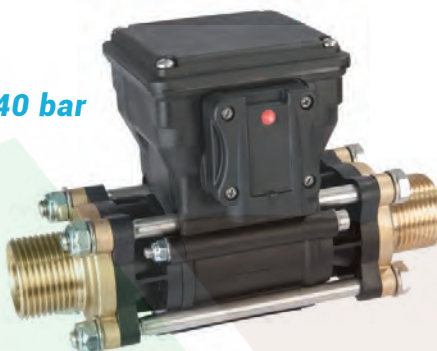

- CAUDALÍMETRO ELECTROMAGNETICO SIN ELEMENTOS MECÁNICOS EN MOVIMIENTO
- FUNCIONAMIENTO INDEPENDIENTE DE LA DENSIDAD Y VISCOSIDAD DEL LÍQUIDO
- BAJA SENSIBILIDAD A LAS TURBULENCIAS
- ELEVADA PRECISION - REDUCIDO MANTENIMIENTO
- ERROR LÍMITE - 0,5 % DEL FONDO ESCALA - PRESION DE TRABAJO HASTA 40 BAR
- MATERIALES: POLIPROPILENO Y ACERO INOX 316
- ALIMENTACION 11-15 Vcc



CÓDIGO	LT/1'	BAR	CONEX.	P.V.P. €
46211A 11313	1 - 20	20	3/4"	637,00
46211A 23333	2,5 - 50	40	3/4"	652,00
46211A 41414	10-200	20	1"	637,00
46221A 51616	20 - 400	20	1" 1/2	637,00
46221A 61717	30 -600	20	2"	652,00
4621AA10000.100	Cable alimentacion 3 mts. 3 polos			18,29

orion2



- PANTALLA INTEGRADA
- VISUALIZACION INSTANTANEA LT/1' Y TOTAL LITROS ACUMULADOS

CÓDIGO	LT/1'	BAR	CONEX.	P.V.P. €
46212A 41414	10 - 200	20	1"	767,00
46222A 51616	20 - 400	20	1" 1/2	767,00
46222A 61717	30 - 600	20	2"	780,00
46222A 5100	Cable alimentacion 3 mts. 4 polos			24,70

DISPONIBLES OTRAS MEDIDAS Y RANGOS DE MEDICION - ROGAMOS CONSULTEN



CAUDALÍMETRO DE TURBINA

- ALTA PRECISION Y EXCELENTE RELACION CALIDAD / PRECIO
- LED INDICADOR DE FUNCIONAMIENTO
- PERNO DE ZAFIRO , MÍNIMO ROCE , MÁXIMA SENSIBILIDAD Y PRECISION
- GRUPO TURBINA "TWIST" PARA UNA LIMPIEZA Y SUSTITUCION SIN HERRAMIENTAS
- CAUDALES DE 2,5 A 800 l/min.
- ALIMENTACION: 4.5 – 26 Vcc, CONSUMO MÁX. 25 mA
- PIEZAS EN CONTACTO CON EL LÍQUIDO DE NYLON REFORZADO CON FIBRA DE VÍDRIO Y DELRIN
- ERROR TÍPICO 1% DE VALOR MÁXIMO



CÓDIGO	LT/1'	BAR	CONEX.	P.V.P. €
462 62A03	2.5-50	40	3/4" M	325,18
462 63A03	5-100	40	3/4" M	
462 63A04	5-100	40	1" M	
462 64A03	10-200	40	3/4" M	
462 64A04	10-200	40	1" M	



KIT TURBINA

CÓDIGO	P.V.P. €
4626000.503	74,23



CABLE ALIMENTACIÓN

CÓDIGO	P.V.P. €
4621AA10000.100	18,29

CAUDALÍMETRO PARADA AUTOMÁTICA 12V

SISTEMA DE CARGA CISTERNA TRANSPORTABLE

- PARADA AUTOMÁTICA CIERRE VÁLVULA AL ALCANZAR LA CANTIDAD PROGRAMADA
- MEDIDOR DE CAUDAL DE 20 A 400 l/min.
- DISPLAY RETROILUMINADO
- VÁLVULA ELÉCTRICA CON BOLA DE ACERO INOX
- TOMAS ROSCADAS DE 2" MACHO
(249067 X 2 + 010006 X 2 A PEDIR POR SEPARADO)
- SOPORTE CON MANETA PARA EL TRANSPORTE
- CABLE DE ALIMENTACIÓN. LONGITUD 10 m
- TENSIÓN DE ALIMENTACIÓN 12 Vcc



CÓDIGO	P.V.P. €
462F4501	960,00

ALIMENTADOR UNIVERSAL DE 12 Vdc (110÷240 Vac) PARA SISTEMA DE CARGA CISTERNA



CÓDIGO	P.V.P. €
467 006	168,81



GRUPOS DE MANDO CON VÁLVULAS DE BOLA



CONEXIONES T 6

- * GRUPO DE MANDO GENERAL PARA ORDENADORES BRAVO Y DELTA
- * VÁLVULA GENERAL 3 VIAS (1,4")
- * VÁLVULA DE REGULACION PROPORCIONAL RÁPIDA (ACCIÓN 7 SEG.) DE BOLA INOX PERFILADA PARA UN FLUJO MAS LINEAL Y PRECISO.
- * CAUDAL MAX (1,5 bar) - 480 L/MN
- * PRESION MAX 12 bar

CÓDIGO	P.V.P.€
853 GA7C00A	613,00

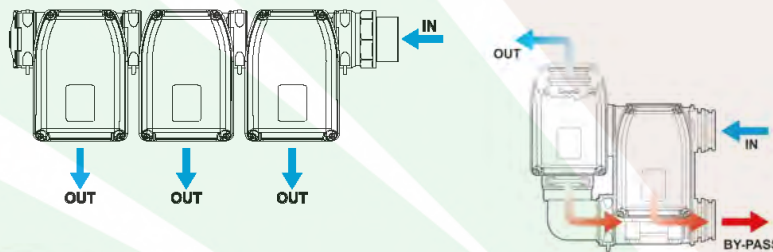

CONEXIONES T 6

- * VÁLVULA DE SECCIÓN BOLA INOX
- * SISTEMA MODULAR -
- * CAUDAL MAX 290 L/MN (A 0,5 bar)
- * EL CAUDAL PUEDE VARIAR SEGÚN EL NÚMERO DE SECCIONES INSTALADAS -
- * PRESION MAX 12 bar

CÓDIGO	P.V.P.€
853 K04SC6	300,24

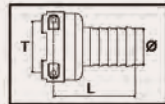

COD. CODE COD.	T	Ø (mm)	L (mm)	Mat.	Ø	COD. CODE COD.
1090625	T6	25	60	PA	10	010006
1090630		30	65	PA	10	
1090632		32	65	PA	10	
1090635		35	67	PA	10	
1090638		38	73	PA	10	
1090640		40	73	PA	10	
1090650		50	81	PA	10	



COD. CODE COD.	T	Ø (mm)	A (mm)	B (mm)	Mat.	Ø	COD. CODE COD.
1190625	T6	25	54	57	PA	10	010006
1190630		30	54	74	PA	10	
1190632		32	54	74	PA	10	
1190635		35	59	80	PA	10	
1190638		38	59	85	PA	10	
1190640		40	59	85	PA	10	
1190650		50	71	92	PA	10	

T6 = 1" 1/4 PASO TOTAL
1" 1/2 PASO STANDARD

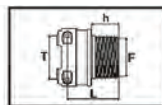

COD. CODE COD.	T	F (BSP)	L (mm)	h (mm)	Mat.	Ø	COD. CODE COD.
249064	T6	G 1" M	46	22	PA	10	010006
249065		G 1" 1/4 M	48	24	PA	10	
249066		G 1" 1/2 M	49	24	PA	10	
249067		G 2" M	47	27	PA	10	

RÁCORES A PEDIR POR SEPARADO



COMPONENTES GRUPO MANDO HERBICIDA ACOPLÉS T5



GRUPO MANDO GENERAL 871 - VAL. REGULADORA 863

TIPO	CÓDIGO	lt/1' - 863	P.V.P. €
ESTÁNDAR	871 520 F50	150	332,75
	871 520 E50	100	
BRAVO	871 520 P50	100	342,17
	871 520 R50	150	



GRUPO MANDO GENERAL 864 - VAL. REGULADORA 873

TIPO	CÓDIGO	lt/1' - 873	P.V.P. €
BRAVO	864 52 U50	200	655,00
	864 52 T50	240	



CAUDALÍMETRO

TIPO	CÓDIGO	RANGO	P.V.P. €
46211A3A5B5	ORION	5 - 100	637,00
46211A4A5B5	ORION	10 - 200	637,00
462 6415	WOLF		243,27
4621AA10000.100	CABLE ALIMENTACION 3 POLOS		18,29



FILTROS CONEXIÓN T5 AUTOLIMPIANTES

CÓDIGO	CARTUCHO	MESH	P.V.P. €
322 21 M3	38 X 125	50 INOX	20,56
326 21 M3	58 X 210	50 INOX	35,02
326 21M35		80 INOX	



CONEXIONES T5 P/ VÁLVULAS 463/863

CÓDIGO	TIPO	P.V.P. €
463 000.157	H 463-HT5	2,92
463 000.056	M 463-MT5	2,92
010005	HORQUILLA	1,30
G11063V	OR T5	2,26

CONECTORES VÁLVULAS

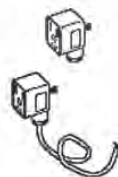

CÓDIGO	P.V.P. €
ECS0033	2,71
8.650.900.140 cable 1,3 m	9,02



COMPONENTES GRUPOS MANDOS HERBICIDAS



T-5-H

VÁLVULA DE CIERRE GENERAL CON MANUAL DE MÁXIMA SERIE 864 20 BAR / 200 LT/1"

CÓDIGO	P.V.P. €
864 050250	499,07



Ø 30

Ø 25

VÁLVULA DE CIERRE GENERAL CON MANUAL DE MÁXIMA SERIE 871 20 BAR / 150 LT/1"

CÓDIGO	P.V.P. €
871 0502	204,63

871

CÓD.	Ø	MAT.*
463 000.130	G 3/4 (BSP)	1
463 000H.130	G 3/4 (BSP)	2
463 000.131	3/4" NPT	1
463 000.140	G 1 (BSP)	1
463 000H.140	G 1 (BSP)	2
463 000.141	1" NPT	1
463 000.150	G 1 1/4 (BSP)	1
463 000.151	1" 1/4 NPT	1

CÓD.	MAT.*
473 000.010	1

CÓD.	Ø	Ør	MAT.*
471 202.B50	G 1 1/4 (BSP)		1
471 202.B51	G 1 1/4 (BSP)	* 19 mm	1
471 202.B52	G 1 1/4 (BSP)	* 16 mm	1

Ør diámetro interior racor porta manguera con venturi

CÓD.	Ø	MAT.*
471 202.C25	25 mm	1
471 202.C30	30 mm	1

CÓD.	Ø	MAT.*
463 000.157	T5	1

CÓD.	Ø	MAT.*
463 000.132	G 3/4 (BSP)	1
463 000.133	3/4" NPT	1
463 000.142	G 1 (BSP)	1
463 000.143	1" NPT	1

CÓD.	Ø	MAT.*
473 001.C25	25 mm	1

CÓD.	Ø	MAT.*
473 001.A19	19 mm	1
473 001.A25	25 mm	1
473 001.A30	30 mm	1
473 001.A32	32 mm	1

CÓD.	Ø	MAT.*
473 001.B30	G 3/4 (BSP)	1
473 001.B40	G 1 (BSP)	1
473 001.B50	G 1 1/4 (BSP)	1

CÓD.	Ø	lt/1'	US GPM	MAT.*
471 202.A40	25 mm	70	19	1
471 202.A41	30 mm	120	32	1
471 202.A43	32 mm	120	32	1
471 202.A45	35 mm	180	48	1

MÁX.

(*) material 1=Nylon 2=Latón

864

CÓD.	Ø	MAT.*
464 400.028	473	1
464 400.029	463	1

CÓD.	Ø	MAT.*
464 400.023	G3/4 (BSP)	1
464 400.024	G1 (BSP)	1
464 400.023	G1 1/4 (BSP)	1

CÓD.	Ø	MAT.*
464 400.026	T5	1

CÓD.	Ø	lt/1'	US GPM	MAT.*
464 402.A40	35 mm	60	16	1
464 402.A41	35 mm	120	32	1
464 402.A42	35 mm	180	48	1
464 402.A43	40 mm	280	74	1

MÁX.

CÓD.	Ø
464 402.150	10 mm
	13 mm
	16 mm
	19 mm
	25 mm

CÓD.	Ø	MAT.*
464 402.A90	25 mm	1
464 402.A91	30 mm	1
464 402.A92	35 mm	1
464 402.A93	38 mm	1



COMPONENTES GRUPOS MANDO HERBICIDAS

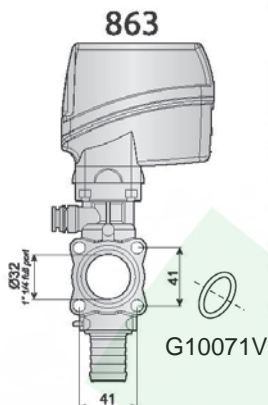

ESTANDAR



BRAVO

VÁLVULAS REGULADORAS

CÓDIGO	lt/1'	P.V.P. €
863 0020	100	140,46
863 0024	150	
863 0022S	60	150,00
863 0020S	100	
863 0024S	150	

VÁLVULA ON/OFF	VÁLVULA 3 VIAS SECCION	REGULACION MANUAL 40 bar-150 lt/1'
CÓDIGO 863 0001	863 0011	463 074
P.V.P. € 128,57	138,62	37,77

CAUDALIMETRO ELECTROMAGNÉTICO

CÓDIGO	lt/1'	P.V.P. €
46211A 30000	5 -100	622,00
46211A 40000	10 -200	

OTROS RANGOS DE MEDICION BAJO PEDIDO

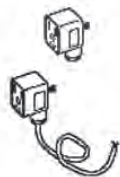

CÓDIGO	P.V.P. €
ECS0033	2,71
8.650.900.140 cable 1,3 m	9,02

FILTROS LINEA 863

CÓDIGO	CARTUCHO	P.V.P. €
322 9113	38 x 125 - 50 Mesh	26,51
326 9113	58 x 210 - 50 Mesh	37,08



CÓDIGO	P.V.P. €
G10071V	2,16
OR CUERPOS	



COMPONENTES RETORNOS COMPENSADOS 863 (463)

Portamanguera recto con conexión hembra

CÓD.	∅
109 0420	20 mm
109 0425	25 mm

Horquilla

CÓD.
010 004

Rosca macho con conexión hembra

CÓD.	Rosca
249 044	G 1 M

Retorno calibrado

CÓD.
463 2010.810

T4H

Horquilla

CÓD.
010 001

Tapón

CÓD.
219 010

Tapón hembra

CÓD.
219 040

Portamanguera curvo con conexión hembra

CÓD.	∅
119 0420	20 mm
119 0425	25 mm
119 0430	30 mm

Portamanguera

CÓD.	∅
109 0113	13 mm
109 0116	16 mm

Portamanguera recto con conexión macho

CÓD.	∅
109 1420	20 mm
109 1425	25 mm

Rosca macho con conexión macho

CÓD.	Rosca
249 144	G 1 M

T4M

O'ring

CÓD.
G11054V

Tapón macho

CÓD.
219 140

Portamanguera curvo con conexión macho

CÓD.	∅
119 1420	20 mm
119 1425	25 mm

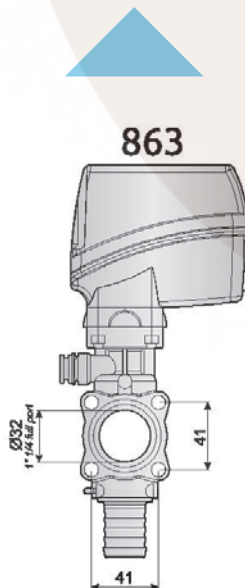

CÓDIGO	P.V.P. €	CÓDIGO	P.V.P. €
010 001	0,58	219 010	0,74
010 004	1,08	219 040	0,99
109 0113	0,77	219 140	1,00
109 0116	0,77	249 044	1,30
109 0420	1,02	249 144	1,30
109 0425	1,02	463 2010.810	10,18
109 1420	1,02	G11054V	2,08
109 1425	1,02		
119 0420	1,44		
119 0425	1,51		
119 0430	1,60		
119 1420	1,51		
119 1425	1,51		

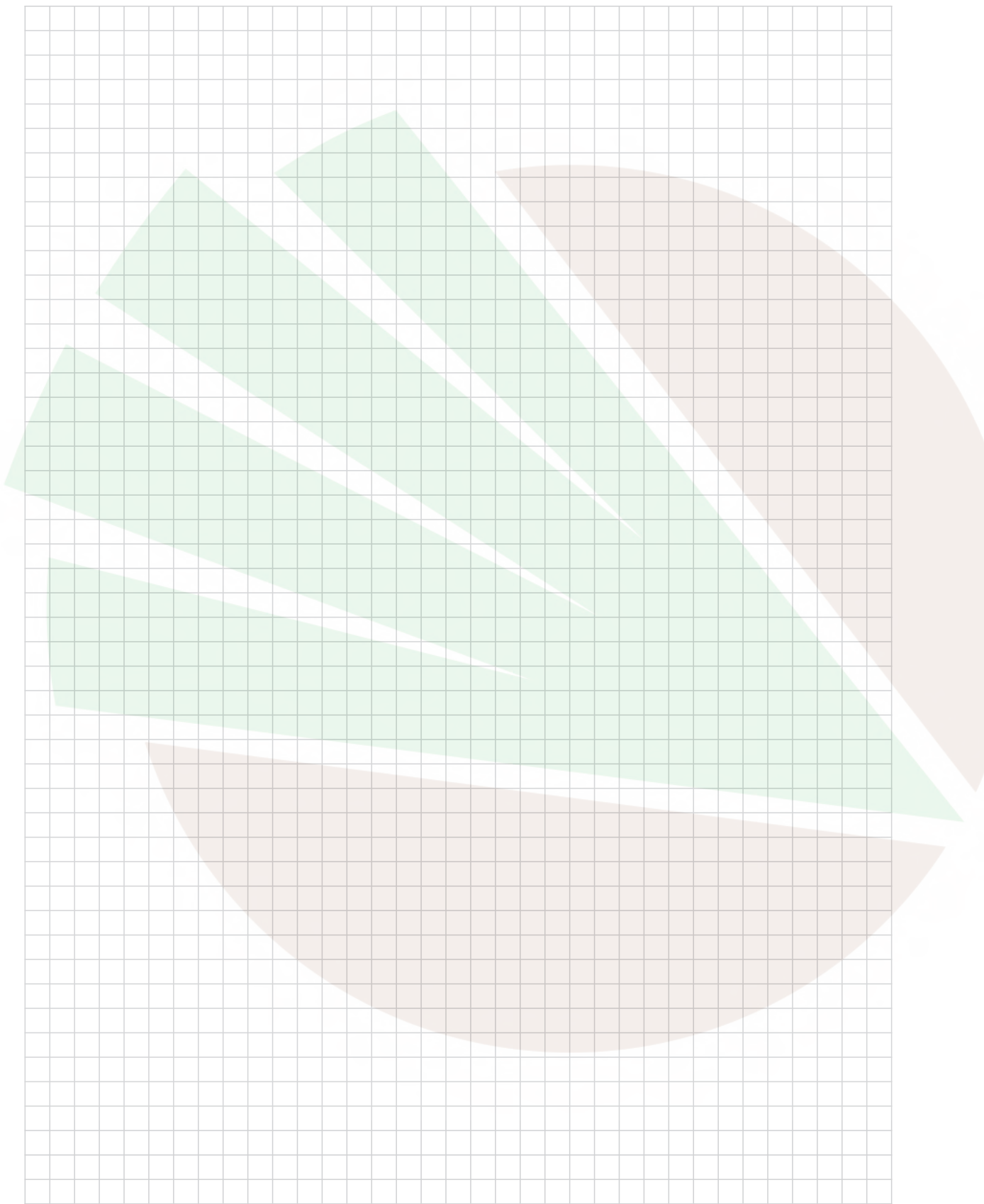



BRIDAS DE ACOUPLE PARA VÁLVULAS 863 (463)

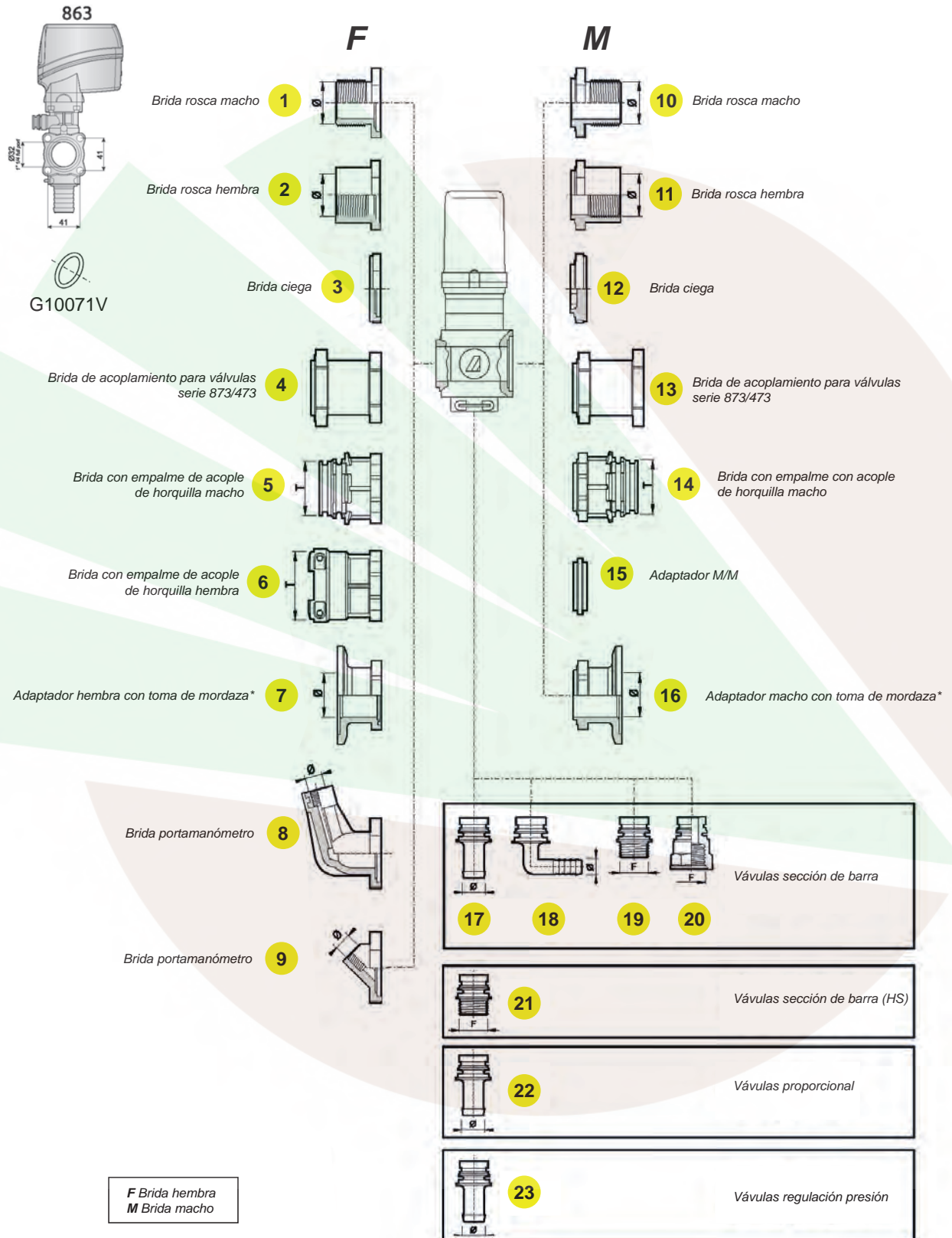

2022



BRIDAS DE ACOPLER PARA VÁLVULAS 863 (463)

1 Brida rosca macho

CÓD.	Ø	MAT.*
463 000.130	G 3/4 (BSP)	1
463 000H.130	G 3/4 (BSP)	2
463 000.131	3/4" NPT	1
463 000.140	G1 (BSP)	1
463 000H.140	G1 (BSP)	2
463 000.141	1" NPT	1
463 000.150	G1 1/4 (BSP)	1
463 000.151	1" 1/4 NPT	1

2 Brida rosca hembra

CÓD.	Ø	MAT.*
463 000.132	G 3/4 (BSP)	1
463 000.133	3/4" NPT	1
463 000.142	G1 (BSP)	1
463 000.143	1" NPT	1

3 Brida ciega

CÓD.	MAT.*
463 011.120	1
463 011H.120	2

4 Brida de acoplamiento para válvulas serie 873/473

CÓD.	MAT.*
473 000.110	1

5 Brida con empalme con acople de horquilla macho

CÓD.	T	MAT.*	O'ring	
			EPDM	Viton®
463 000.156	T5	1	G11063	G11063V

6 Brida con empalme con acople de horquilla hembra

CÓD.	T	MAT.*	Horquilla
463 000.157	T5	1	010005

7 Adaptador hembra con toma de mordaza*

CÓD.	Ø	MAT.*
463 000.165	2" STANDARD PORT	1

8 Brida portamanómetro

CÓD.	Ø	MAT.*
463 011.130	G 1/4 (BSP)	1
463 011N.130	1/4" NPT	1

9 Brida portamanómetro

CÓD.	Ø	MAT.*
463 011H.130	G 1/4 (BSP)	2

10 Brida rosca macho

CÓD.	Ø	MAT.*
463 000.030	G 3/4 (BSP)	1
463 000H.030	G 3/4 (BSP)	2
463 000.031	3/4" NPT	1
463 000.040	G1 (BSP)	1
463 000H.040	G1 (BSP)	2
463 000.041	1" NPT	1
463 000.050	G1 1/4 (BSP)	1
463 000.051	1" 1/4 NPT	1

11 Brida rosca hembra

CÓD.	Ø	MAT.*
463 000.032	G 3/4 (BSP)	1
463 000.033	3/4" NPT	1
463 000.042	G1 (BSP)	1
463 000.043	1" NPT	1

12 Brida ciega

CÓD.	MAT.*
463 011.110	1

13 Brida de acoplamiento para válvulas serie 873/473

CÓD.	MAT.*
473 000.010	1

14 Brida con empalme con acople de horquilla macho

CÓD.	T	MAT.*	O'ring	
			EPDM	Viton®
463 000.056	T5	1	G11063	G11063V

15 Adaptador M/M

CÓD.	MAT.*
463 011.135	1

16 Adaptador macho con toma de mordaza*

CÓD.	Ø	MAT.*
463 000.065	2" STANDARD PORT	1

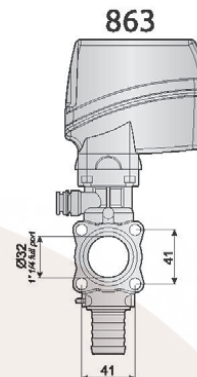

Racores para la descarga

CÓD.	Ø	MAT.*
463 001.A10	10 mm	1
463 001.A13	13 mm	1
463 001.A16	16 mm	1
463 001.A19	19 mm	1
463 001.A25M	25 mm	1

CÓD.	Ø	MAT.*
463 001.C13	13 mm	1

CÓD.	Ø	MAT.*
463 001.B70	G3/4 (BSP)	1
463 001.B40M	G1 (BSP)	1

CÓD.	Ø	MAT.*
463 001.B75	G3/4 (BSP)	1
463 001.B75M	3/4" NPT	1

CÓD.	Ø	MAT.*
463 001.B20	G1/2 (BSP)	2
463 001.B21M	G1/2 (BSP)	2

863001H - 863011H

CÓD.	Ø	MAT.*
463 001.A13	13 mm	1
463 001.A19	19 mm	1
463 001.A25	25 mm	1

CÓD.	Valv.	Ø	MAT.*
	463 080		
463 080.A19	463 081	19 mm	1
	463 082		
	463 083		
463 082.A19	463 082	19 mm	1

*Compatible con tomas tipo Banjo®, Hypro® y Bee Valve®

(*) material
1=Nylon
2=Latón

2022



COMPONENTES VÁLVULAS HERBICIDAS SERIE 873 (473)

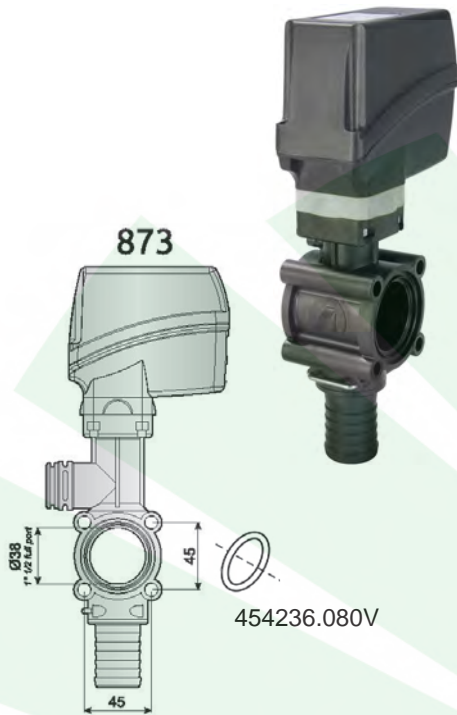

VÁLVULA REGULACION GRAN CAUDAL

TIPO	CÓDIGO	lt/1'	P.V.P. €
BRAVO	873 00 22S	190	175,00
	873 00 20S	240	



**FILTRO AUTOLIMPIANTE
- CARTUCHO 58 X 210**

CÓDIGO		P.V.P. €
326 9103	STANDARD	37,08
326 9133	CONEXIÓN * 873-863	



CAUDALIMETRO ORION 473

CÓDIGO	RANGO	P.V.P. €
4622 1A40000	10 - 200	622,00
46221A50000	20-400	

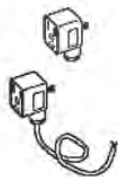

CÓDIGO	P.V.P. €
ECS0033	2,71
8.650.900.140 cable 1,3 m	9,02



CÓDIGO	P.V.P. €
454236.080V	1,96
OR CUERPOS	



COMPONENTES RETORNOS COMPENSADOS 873 (473)

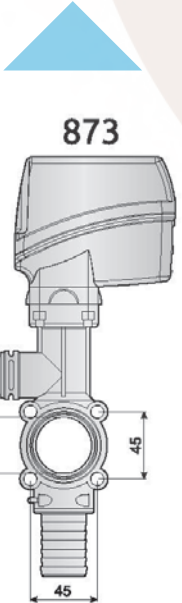
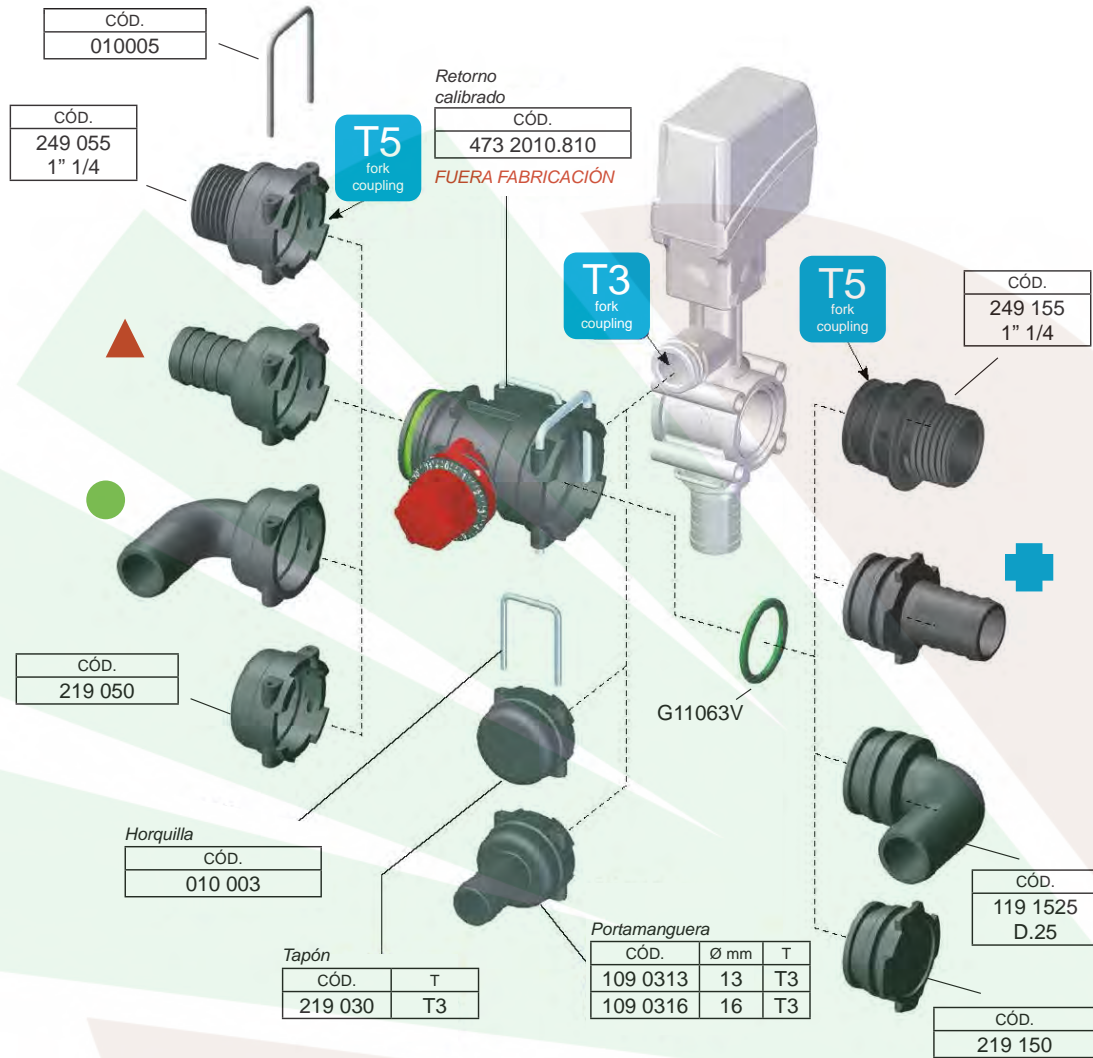

CÓDIGO	P.V.P. €
010003	0,92
010005	1,30
109 0313	0,77
109 0316	0,81
119 1525	1,51
219 030	0,88
219 050	1,23
219 150	1,23
249 055	1,63
249 155	1,63

CÓDIGO	CÓDIGO	CÓDIGO	Ø
119 0520	109 0520	109 1520	20
119 0525	109 0525	109 1525	25
119 0530	109 0530	109 1530	30
119 0535	109 0535	109 1535	35
119 0540	109 0540	109 1540	40

2022



BRIDAS DE ACOUPLE PARA VÁLVULAS 873 (473)

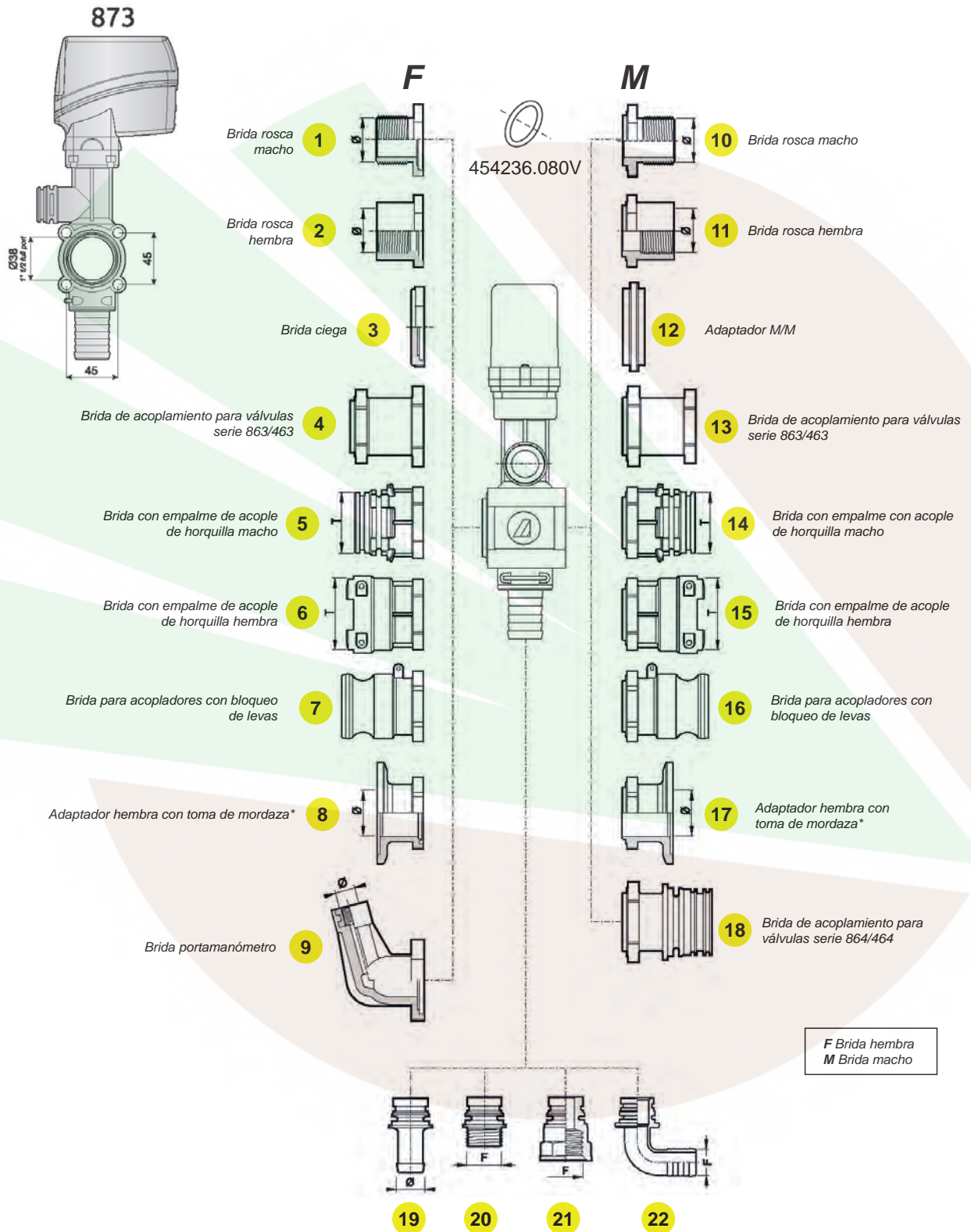

2022



BRIDAS DE ACOPLE PARA VÁLVULAS 873 (473)

1 Brida rosca macho

CÓD.	Ø	MAT.
473 000.150	G1 1/4 (BSP)	Nylon
473 000.151	1 1/4 NPT	Nylon
473 000.160	G1 1/2 (BSP)	Nylon
473 000.161	1 1/2 NPT	Nylon
473 000.170	G2 (BSP)	Nylon
473 000.171	2 NPT	Nylon

2 Brida rosca hembra

CÓD.	Ø	MAT.
473 000.152	1 1/4 (BSP)	Nylon
473 000.153	1 1/4 NPT	Nylon
473 000.163	1 1/2 NPT	Nylon

3 Brida ciega

CÓD.	MAT.
473 011.120	Nylon

4 Brida de acoplamiento para válvulas serie 863/463

CÓD.	MAT.
473 000.110	Nylon

5 Brida con empalme con acople de horquilla macho

CÓD.	T	MAT.	O'ring	
			EPDM	Viton®
473 000.156	T5	Nylon	G11063	G11063V
473 000.166	T6	Nylon	G11023	G11023V

6 Brida con empalme con acople de horquilla hembra

CÓD.	T	MAT.	Horquilla
473 000.157	T5	Nylon	010005
473 000.167	T6	Nylon	010006

7 Brida para acopladores con bloqueo de levas

CÓD.	Ø	MAT.
473 000.164	1" 1/2	Nylon
473 000.174	2"	Nylon

8 Adaptador hembra con toma de mordaza*

CÓD.	Ø	MAT.
473 000.175	2" FULL PORT	Nylon
473 000.165	2" STANDARD PORT	Nylon

9 Brida portamanómetro

CÓD.	Ø	MAT.
473 011.130	G 1/4 (BSP)	Nylon
473 011N.130	1/4" NPT	Nylon

10 Brida rosca macho

CÓD.	Ø	MAT.
473 000.050	G 1 1/4 (BSP)	Nylon
473 000.051	1 1/4 NPT	Nylon
473 000.060	G 1 1/2 (BSP)	Nylon
473 000.061	1 1/2 NPT	Nylon
473 000.070	G 2 (BSP)	Nylon
473 000.071	2 NPT	Nylon

11 Brida rosca hembra

CÓD.	Ø	MAT.
473 000.052	1 1/4 (BSP)	Nylon
473 000.053	1 1/4 NPT	Nylon
473 000.063	1 1/2 (BSP)	Nylon

12 Adaptador M/M

CÓD.	MAT.
473 011.135	Nylon

13 Brida de acoplamiento para válvulas serie 863/463

CÓD.	MAT.
473 000.010	Nylon

14 Brida con empalme con acople de horquilla macho

CÓD.	T	MAT.	O'ring	
			EPDM	Viton®
473 000.056	T5	Nylon	G11063	G11063V
473 000.066	T6	Nylon	G11023	G11023V

15 Brida con empalme con acople de horquilla hembra

CÓD.	T	MAT.	Horquilla
473 000.067	T6	Nylon	010006

16 Brida para acopladores con bloqueo de levas

CÓD.	Ø	MAT.
473 000.064	1" 1/2	Nylon
473 000.074	2"	Nylon

17 Adaptador hembra con toma de mordaza*

CÓD.	Ø	MAT.
473 000.075	2" FULL PORT	Nylon
473 000.065	2" STANDARD PORT	Nylon

18 Brida de acoplamiento para válvulas serie 864/464

CÓD.	MAT.
464 400.028	Nylon

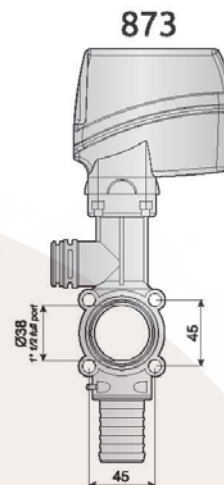

Racores para la descarga

CÓD.	Ø	MAT.
473 001.A19	19 mm	Nylon
473 001.A25	25 mm	Nylon
473 001.A30	30 mm	Nylon
473 001.A32	32 mm	Nylon

CÓD.	Ø	MAT.
473 001.B30	G3/4 (BSP)	Nylon
473 001.B40	G1 (BSP)	Nylon
473 001.B50	G1 1/4 (BSP)	Nylon

CÓD.	Ø	MAT.
473 001.B45N	1" NPT	Nylon

CÓD.	Ø	MAT.
473 001.C25	25 mm	Nylon

2022



MANDOS BAJA PRESIÓN - HERBICIDAS - VÁLVULA REGULADORA DE MÁXIMA PRESIÓN

CIRCLIP EXTRAIBLE PARA BLOQUEO DEL POMO A LA PRESIÓN ESTABLECIDA

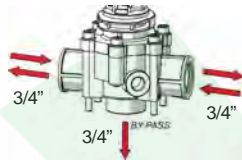

DESCRIPCIÓN	CÓDIGO	P.V.P. €
* VÁLVULA DE MEMBRANA CON CONEXIONES ROSCADAS 3/4" H * MAX 200 l/mn - 30 bar * CUERPO DE NYLON REFORZADO - INTERIOR EN DERLIN E INOX - JUNTAS VITON	475 533	70,56

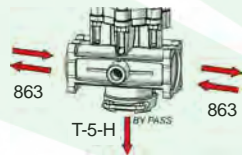

DESCRIPCIÓN	CÓDIGO	P.V.P. €
*VÁLVULA DE MEMBRANA CON CONEXIÓN BRIDA 863 - BY-PASS T-5-H (rácor no incluido) *MAX 150 l/mn - 10 bar	475 511	70,56

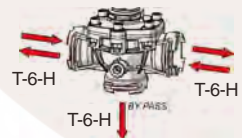

HI-FLOW - 450 l/mm

DESCRIPCIÓN	CÓDIGO	P.V.P. €
CONEXION HORQUILLA T-6 -H (RÁCORES no INCLUIDOS) PRESIÓN *MÁX. 12 bar	475 5612	102,80

2022



MANDOS BAJA PRESION - HERBICIDAS -

MANDO - CB -



DESCRIPCIÓN	VÍAS	CÓDIGO	P.V.P. €
PRESIÓN CONSTANTE RETORNOS COMPENSADOS (volumétricos) PALANCA DE CIERRE TOTAL 120 l/mn - 20 bar	3	560 300 100	285,00
	4	560 400 100	305,00
	5	560 500 100	350,00

MANDO - SB -



DESCRIPCIÓN	VÍAS	CÓDIGO	P.V.P. €
PRESIÓN CONSTANTE PALANCA DE CIERRE TOTAL 120 l/mn - 20 bar	3	460 300 100	225,00

MANDO - DS -



DESCRIPCIÓN	VÍAS	CÓDIGO	P.V.P. €
CUERPO ALUMINIO - ENTRADA H 1/2" - 100 l/mn - 20 bar	3	601 049	118,00

MANDO - DL -



DESCRIPCIÓN	VÍAS	CÓDIGO	P.V.P. €
PLASTICO REFORZADO - ENTRADA H - 1/2" - 100 l/mn - 20 bar	3	601 096	95,00

GRUPO MANUAL 471



DESCRIPCIÓN	VÍAS	CÓDIGO	P.V.P. €
MANUAL PROPORCIONAL VÁLVULA DE MÁXIMA REGULADORA PROPORCIONAL RETORNOS COMPENSADOS	3	471 230 2BO	275,00
	5	471 250 2BO	340,00

VÁLVULAS - 463

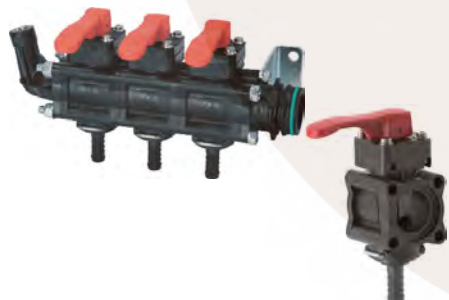

DESCRIPCIÓN	CÓDIGO	P.V.P. €
GRUPO VÁLVULAS MANUAL 3 VIAS ENTRADA T-5M	463 05351	87,27
MODULO SUELTO P/AMPLIACION GRUPO 463	463 051	20,13

VÁLVULAS - 461



DESCRIPCIÓN	VÍAS	CÓDIGO	P.V.P. €
GRUPO VÁLVULAS MANUALES ENTRADA ROSCADA 1"	3	461 031	57,35
	4	461 041	67,09

DESCRIPCIÓN	CÓDIGO	P.V.P. €
GRIFO SUELTO P/ AMPLIACION GRUPO 4 VIAS A MAX. 6 VIAS	464.402.151	22,00



MANDO ELECTRICO ATOMIZADOR

DISTRIBUIDOR ELECTRICO 2 VIAS - RETORNOS COMPENSADOS



VÁLVULA DE REGULACIÓN ELECTRICA

DESCRIPCIÓN	CÓDIGO	P.V.P. €
* 2 VÁLVULAS DE SECCION CON RETORNOS COMPENSADOS * VÁLVULA REGULADORA ELECTRICA MAX. 150 L/ MN - 40 BAR * ENTRADA 3/4 " - SALIDAS (2) 1/2" - RETORNO REGULADORA 1" M - RETORNOS VIAS CODO D.25 * CAJA DE MANDO NO INCLUIDA	K863ELE01	530,00

CAJA DE MANDO COMPACTA 4668



DESCRIPCIÓN	CÓDIGO	P.V.P. €
* 2 SECCIONES DE SALIDA + REGULACION PRESION + MANDO GENERAL (POSIBILIDAD DE ACCIONAR VÁLVULA GENERAL ADICIONAL - ON/OFF) * (INCLUYE CABLEADO DIRECTO 2 M ALIMENTACIÓN + 4 M. A VÁLVULAS)	4668 5230	146,78

VÁLVULA DE REGULACIÓN MAX PRESIÓN MANUAL



DESCRIPCIÓN	CÓDIGO	P.V.P. €
* 2 VÁLVULAS DE SECCION CON RETORNOS COMPENSADOS * VÁLVULA REGULADORA DE MAXIMA PRESION MANUAL MAX 150 L/MN - 40 BAR * ENTRADA 3/4 " - SALIDAS (2) 1/2" - RETORNO REGULADORA 1" M - RETORNOS VIAS CODO D.25 * CAJA DE MANDO NO INCLUIDA	K863CEY01	422,00



KIT MANÓMETRO 4668

DESCRIPCIÓN	CÓDIGO	ESCALA	P.V.P. €
* GLICERINA ESFERA Ø63 ANEXABLE EN DISTINTAS POSICIONES A CAJAS 4668.	4668 12	0...25	44,29
	4668 13	0...40	
	4668 14	0...60	
* Tubo rilsan de 6 m y rácores incluidos	4668 22	0..5/25	88,06
	4668 24	0...20/60	

CAJA DE MANDO COMPACTA 4668

DESCRIPCIÓN	CÓDIGO	P.V.P. €
* 2 SECCIONES DE SALIDA * INCLUYE CABLEADO DIRECTO 2 M ALIMENTACIÓN + 4 M. A VÁLVULAS)	4668 5200	87,04

DIGIBLOC 4668

DESCRIPCIÓN	CÓDIGO	P.V.P. €
PANTALLA DIGITAL CABLE ALIMENTACIÓN 2 m y CABLE CONEXION A TRASDUCTOR 3 m INCLUIDOS	4668 3B	131,84

TRASDUCTOR DE PRESION



CÓDIGO	TIPO	P.V.P. €
466 113.200	0 - 20 bar	163,95
466 113.500	0 - 50 bar	



ALARGO cable sensor 5 m

CÓDIGO	P.V.P. €
466 553.230	26,18



MANDO ELECTRICO ATOMIZADOR

GRUPO VÁLVULAS 2 VIAS - 120 l/ mn - 40 bar



DESCRIPCIÓN	CÓDIGO	P.V.P. €
* 2 VÁLVULAS DE SECCION CON RETORNOS COMPENSADOS - 8630011H * VÁLVULA REGULADORA PROPORCIONAL DPA - 8630020 * VÁLVULA GENERAL ON-OFF - 8630001H * VÁLVULA DE MÁXIMA PRESION DE MEMBRANA SERIE 475 - 475514 * CODO Y LATIGUILLO RETORNOS Ø 25 INCLUIDOS	K863 525 4E0H	677,00

CAJA DE MANDO DE 2 SECCIONES - 4668



DESCRIPCIÓN	CÓDIGO	DESCRIPCIÓN	P.V.P. €
* INTERRUPTORES: GENERAL ON/OFF - REGULACION - VÍAS * INDICADORES LED ALTO BRILLO * CABLEADO DIRECTO O SEPARABLE * CARCASA PREVISTA PARA SOPORTE CAJA MANOMETRO	4668 5230	Cableado directo alimentación 2 m - Válvulas 4 m	146,78
	K4668 5235	Cableado separable alimentación 2 m - Válvulas 0,50 m + Cable independiente a válvulas de 5 m	247,23

CAJA DE MANDO DE 2 SECCIONES - 4663



RECAMBIOS DISPONIBLES HASTA FIN DE EXISTENCIAS

DESCRIPCIÓN	CÓDIGO	P.V.P. €
PLACA CIRCUITO CON INTERRUPTORES 2 VIAS	4663520.050	113,26
CABLE ALIMENTACION 2 m	466550.080	11,64
KIT TUBO 6 m C/RÁCORES P/ MANOMETRO	466520B.500	27,50
SOLO CABLE TUBO RISLAN - 6 m	466303.083	10,03

KIT SEPARADOR LÍQUIDO PARA MANÓMETRO

Permite usar el manometro en cabina sin presencia de producto químico



CÓDIGO	DESCRIPCIÓN	P.V.P. €
466 350	Kit para caja Serie 4663	32,84
466 352	Kit universal - incluye tubo y rácores	43,76



ORDENADOR PARA ATOMIZADORES Y NEBULIZADORES



COMPLETO DE CABLEADO Y SENSOR VELOCIDAD INDUCTIVO

CÓDIGO		P.V.P. €
467 183203	2 VIAS	1.273,00

BRAVO 180 S

ELEVADAS PRESTACIONES - SIMPLE MANEJO - COMPACTO Y ECONÓMICO

- CONTROL AUTOMÁTICO DE LA DISTRIBUCIÓN
- PUERTO USB PARA TRANSFERENCIA DATOS Y ACTUALIZACION SOFTWARE
- REGULACION AUTOMÁTICA POR DETECCIÓN DE CAUDAL O PRESIÓN
- POSIBILIDAD DE TRABAJO EN MANUAL
- INDICADOR NIVEL CISTERNA INTEGRADO
- CIERRE AUTOMÁTICO POR DEBAJO DE PRESIÓN Y/O VELOCIDAD MÍNIMAS PROGRAMADAS
- INCREMENTO Y REDUCCIÓN MOMÉNTANEAS DE LA DOSIFICACION PROGRAMADA
- 10 CONFIGURACIONES DE TRABAJOS MEMORIZABLES
- CALIBRACION DE LA CISTERNA MEDIANTE SENSOR NIVEL OPCIONAL
- ALARMAS VISUALES Y SONORAS

DISPLAY RETROILUMINADO

DATOS QUE PUEDEN VISUALIZARSE:

- DOSIFICACIÓN - VELOCIDAD - PRESIÓN - CAUDAL - CANTIDAD DISTRIBUIDA - NIVEL CISTERNA - SUPERFICIE Y DURACION DEL TRATAMIENTO

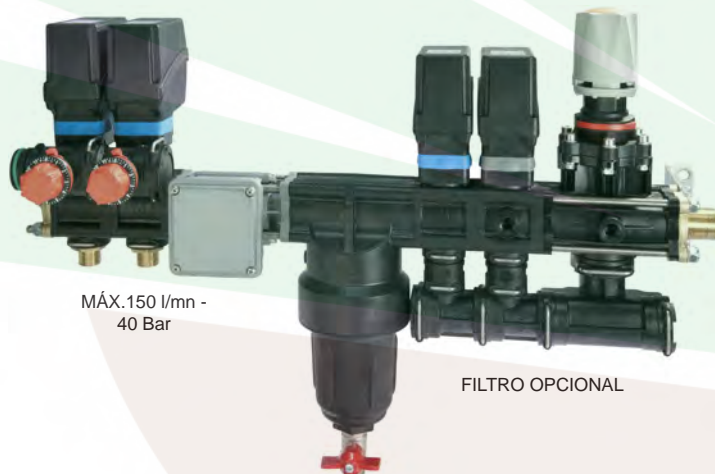

MÁX.150 l/mn - 40 Bar

FILTRO OPCIONAL

GRUPO DE MANDO ATOMIZADOR PARA BRAVO 180S

- * VÁLVULA GENERAL ON - OFF
- * VÁLVULA REGULADORA PROPORCIONAL
- * VÁLVULA MANUAL DE MÁXIMA PRESIÓN
- * VÁLVULAS DE SECCIÓN CON RETORNOS COMPENSADOS
- * CAUDALÍMETRO ELECTROMAGNÉTICO ORION
- SIN PARTES MECANICAS EN MOVIMIENTO
- INSENSIBLE A LA DENSIDAD Y VISCOSIDAD DEL LÍQUIDO

CÓDIGO		P.V.P. €
863 525 4POCH	2 VIAS	1.294,00



SENSORES OPCIONALES

CÓDIGO	DESCRIPCIÓN	P.V.P. €
466 113.200	SENSOR DE PRESION 0-20 BAR	163,95
466 113.500	SENSOR DE PRESION 0-50 BAR	
466 113.004	SENSOR DE NIVEL	414,02
467 100.091	SENSOR VELOCIDAD CABLE ISO 11786	76,12
467 180000.090	SENSOR VELOCIDAD ISO 11786 A MONITOR	101,85
467 01652	ANTENA ATLAS 100	324,64



COMPONENTES GRUPOS MANDOS ATOMIZADOR

863

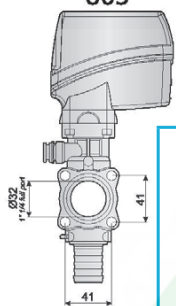

	REGULADORAS		GENERAL ON/OFF	SECCION-VIAS
CÓDIGO	863 0020 ESTÁNDAR	863 0020S BRAVO	863 0001H	863 0011H
P.V.P. €	140,46	149,98	137,10	146,63



	MANUALES			CAUDALIMETRO 5-100	FILTRO
CÓDIGO	463 082	463 074	475514	46211A30000	3452 0030
P.V.P. €	45,48	37,77	70,56	622,00	32,24

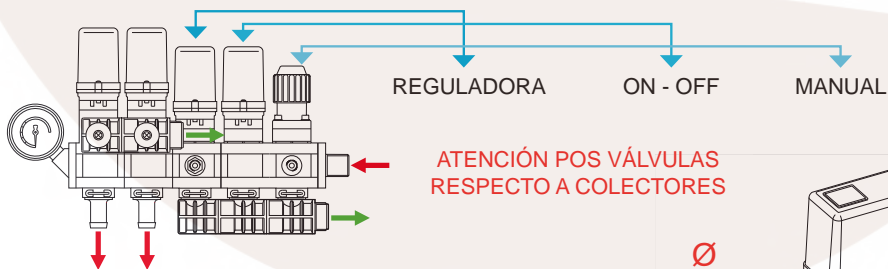

PARA VÁLVULAS

	463 001HS	463 020	463 024	463 082
	ON-OFF	REGULADORA	REGULADORA	MANUAL
POS	Ø 12,5	Ø 14	Ø 16	Ø 16
1	463001H.300	463.001.300	463.024.300	463.082.300
2	463001H.302	463.001.302	463.024.302	463.082.302
3	463001H.304	463.001.304	463.024.304	463.082.304

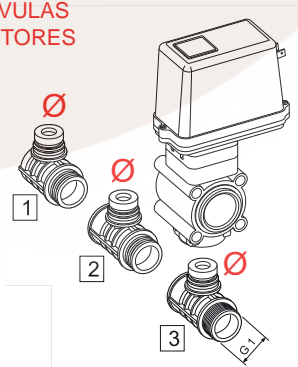



COMPONENTES RETORNOS ATOMIZADOR

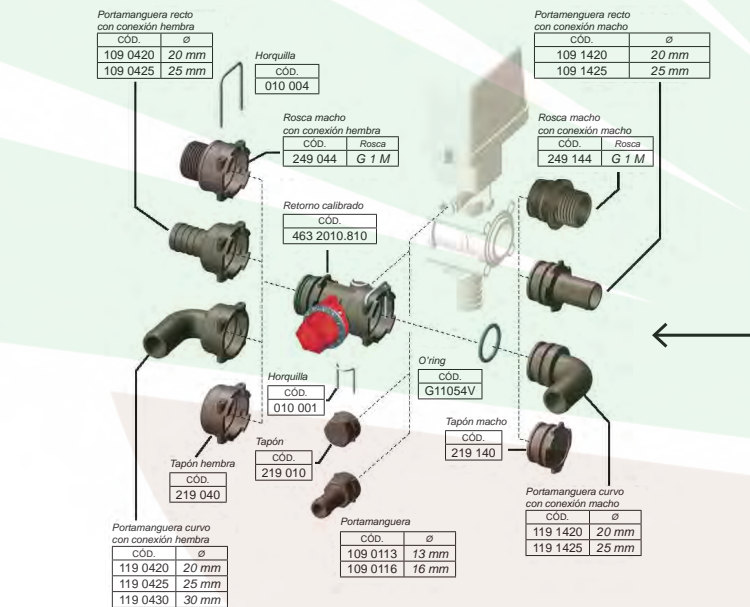
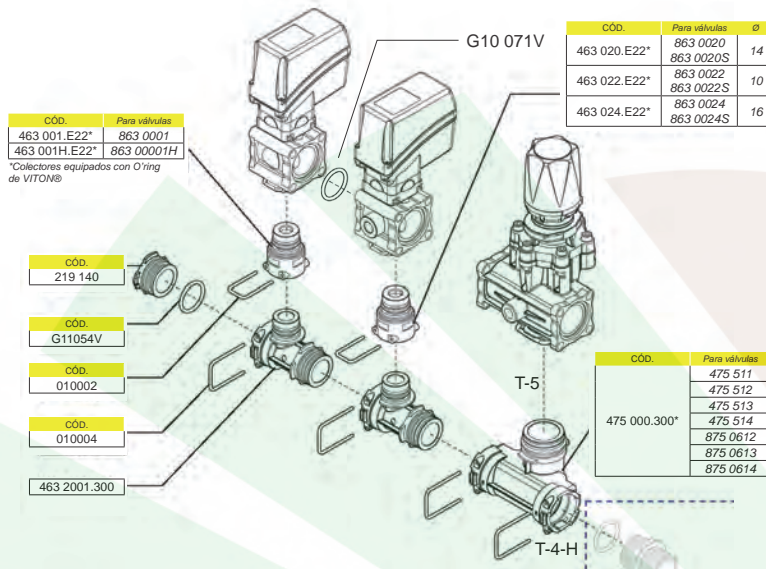

CÓDIGO	P.V.P. €
010 001	0,58
010 002	0,79
010 004	1,08
109 0113	0,77
109 0116	0,77
109 0420	1,02
109 0425	1,02
109 1420	1,02
109 1425	1,02
119 0420	1,44
119 0425	1,51
119 0430	1,60
119 1420	1,51
119 1425	1,51
219 010	0,74
219 040	0,99
219 140	1,00
249 044	1,30
249 144	1,30
463 001.E22 Ø 12,5	2,27
463 001H.E22 Ø 10	2,27
463 020.E22 Ø 14	2,27
463 022.E22 Ø 10	2,27
463 024.E22 Ø 16	2,27
463 2001.300	4,12
463 2010.810	10,18
475 000.300	4,87
G11054V	2,08

VÁLVULA REGULACIÓN PROPORCIONAL

TIPO	Ø	CÓDIGO
463020-463020S	14	463.020.130
8630020-8630020S		
463022-463022S	10	463.022.130
8630022-8630022S		
462024-463024S	16	463.024.130
8630024-8630024S		

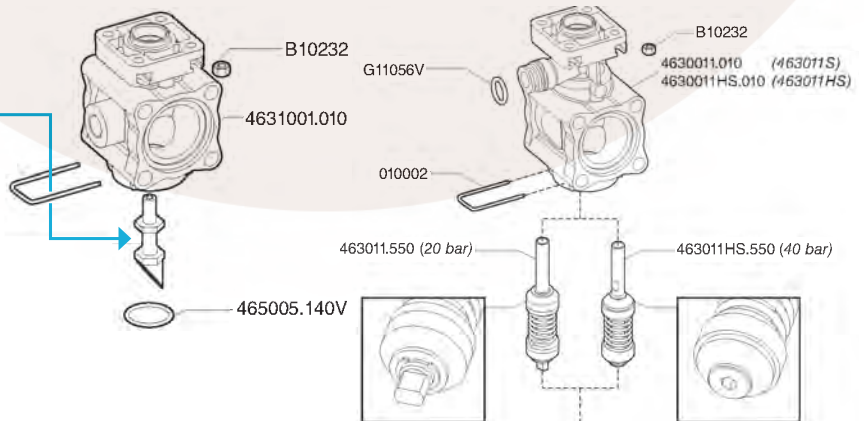

VÁLVULA DE SECCIÓN



VÁLVULAS REGULADORAS ELÉCTRICAS PRESIÓN MÁXIMA DE MEMBRANA

- * IDONEAS PARA MANDOS CON VÁLVULAS SOLENOIDES
- * DERIVAN EL LIQUIDO EN EXCESO PERMITIENDO MANTENER CONSTANTE LA PRESIÓN EN LA LÍNEA.
- * TAMAÑOS COMPACTOS - ESTRUCTURA DE NAYLON REFORZADO, PIEZAS INTERNAS EN DERLIN® Y ACERO INOX AISI303 - JUNTAS DE VITON



CÓDIGO	DESCRIPCIÓN	P.V.P. €
865 0635S	CAUDAL MAX 200 l/mn - Presión Max 50 bar CONEXIONES - ROSCA 3/4 " HEMBRA	280,06



CÓDIGO	DESCRIPCIÓN	P.V.P. €
875 0614	CAUDAL MAX 150 l/mn - Presión Max 40 bar CONEXIONES: IN/OUT - BRIDA 863/463 (Ø32/41) - DESCARGA - T 5 H - (pedir rácores aparte)	266,10



CÓDIGO	PRES MAX	DESCRIPCIÓN	P.V.P. €
875 0660	8 bar	GRAN CAUDAL 450 l/mn	302,35
875 06612	12 bar	CONEXIONES HORQUILLA T 6 H (pedir rácores aparte)	



MANDOS PARA VÁLVULAS SOLENOIDE



CAJAS MANDO COMPACTAS SERIE 4668

DESCRIPCIÓN	VÍAS	GENERAL	PRESIÓN	CÓDIGO	P.V.P. €
INTERRUPTORES ROBUSTOS INDICADORES LED DE ALTO BRILLO	1	-	-	4668 5101	59,74
FUSIBLE GENERAL AUTOREARMABLE	2	-	-	4668 5201	91,67
CABLES DIRECTOS: ALIMENTACION 2 m. CONEXION VÁLVULAS 4 m.	2	✓	-	4668 5211	127,04
	2	✓	✓	4668 5231	142,51

KIT MANÓMETRO 4668



DESCRIPCIÓN	CÓDIGO	ESCALA		P.V.P. €
GLICERINA ANEXABLE EN DISTINTAS POSICIONES A CAJAS 4668 Y 4669.	4668 12	0...25	LINEAL CI 2,5	44,29
	4668 13	0...40		
	4668 14	0...60		
TUBO RILSAN DE 6 m Y RÁCORES INCLUIDOS	4668 22	0..5/25	ISOMETRICO CI 1,6	88,06
	4668 24	0...20/60		

DIGIBLOC 4668



DESCRIPCIÓN	CÓDIGO	P.V.P. €
PANTALLA DIGITAL CABLE ALIMENTACIÓN 2 m y CABLE CONEXION A TRASDUCTOR 3 m INCLUIDOS	4668 3B	131,84

TRASDUCTOR DE PRESION

CÓDIGO	TIPO	P.V.P. €
466 113.200	0 - 20 bar	163,95
466 113.500	0 - 50 bar	



ALARGO cable sensor 5 m

CÓDIGO	P.V.P. €
466 553.230	26,18





ELECTROVÁLVULAS SOLENOIDE ALTA PRESION - 40 bar



GRUPO MANDO SERIE K481

DESCRIPCIÓN	CÓDIGO	P.V.P. €
- 2 VIAS SOLENOIDE - REGULADORA MANUAL - FILTRO 50 Mesh - DESCARGA ON/OFF - ELECTRICA - CAJA MANDO CABLE A VÁLVULAS SECCIONABLE 5m. - 150 l/mn - 40 bar	K481 914 202	650,24

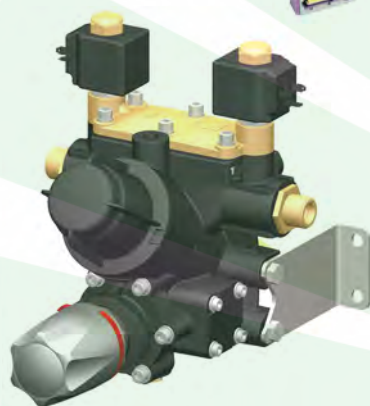

GRUPO MANDO 481

DESCRIPCIÓN	CÓDIGO	P.V.P. €
- 2 VIAS SOLENOIDE - REGULADORA MANUAL - FILTRO 50 Mesh - 150 l/mn - 40 bar	481 814 202	352,22

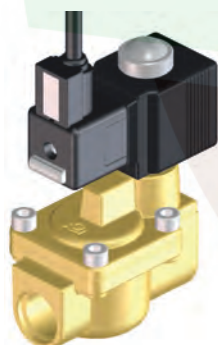

INCLUYE CONECTOR
CON 2 m DE CABLE

SOLENOIDES DE SECCION

CÓDIGO	VÍAS	MAX. l/mn	P.V.P. €
07005 73000 MASOTTI	1 - H 1/2" C/CABLE	80	185,00
481 611	1 - H 1/2"	70	157,99
481 600 002	2 - IN 3/4" OUT - M 1/2"	90 - 120	303,00
481 600 004	4 - IN 3/4" OUT - M 1/2"	150	573,00

2022



**ORDENADOR BRAVO 350S
DETECT PARA SONAR**

bravo350



- NUEVA VERSION CON CABLEADO DIRECTO
GESTION AUTOMATICA DE DOSIS Y SECCIONES**
- PARA TRATAMIENTO LOCALIZADO MEDIANTE SENSORES DE ULTRASONIDOS
 - CONTROL TEMPORIZACIÓN AUTOMATICO DE APERTURA/CIERRE VÁLVULAS SEGÚN LA VELOCIDAD DE AVANCE
 - INDICADOR GRÁFICO NIVEL DE CISTERNA Y ESTADO DE LOS DISPOSITIVOS.
 - ALARMAS VISUALES Y SONORAS DE FUNCIONAMIENTO INCORRECTO
 - ENTRADA DE SEÑALES DE CAUDAL, VELOCIDAD, PRESIÓN Y NIVEL DEPÓSITO
 - POSIBILIDAD DE TRABAJO CON PROGRAMACION MANUAL DE VELOCIDAD (SIN SENSOR DE VELOCIDAD INSTALADO)
 - DISPLAY GRAFICO 240X64 PIXEL, RETROILUMINADO Y LECTOR SD INTEGRADO

2022

COMPLETO DE
CABLEADO

CÓDIGO	P.V.P. €
467 354 B003	1.407,00

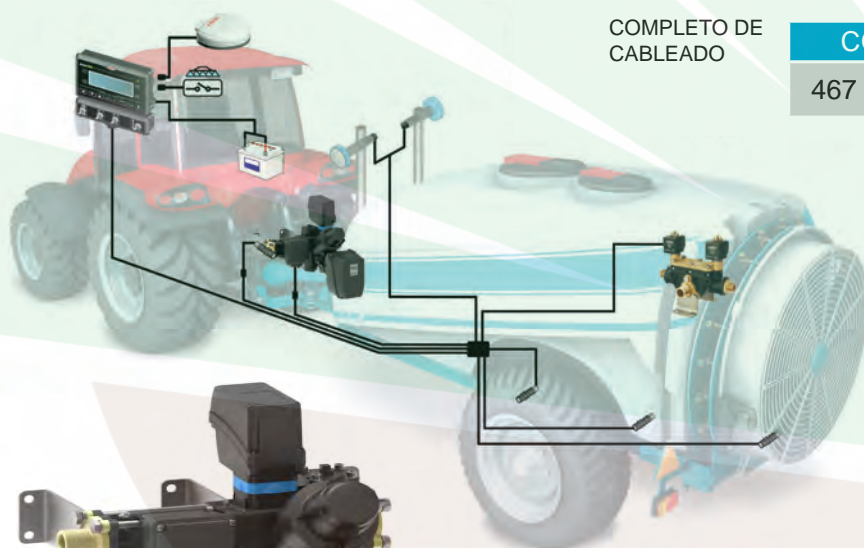

GRUPO VÁLVULA
REGULACIÓN -
SENSOR VELOCIDAD
- ULTRASONIDOS -
SENSORES Y SOLENOIDES
- **NO INCLUIDOS** -
PEDIR POR SEPARADO -



CÓDIGO	DESCRIPCIÓN	P.V.P. €
881 824 200C	GR. REGULACION RAPIDA + CIERRE GENERAL + FILTRO + ORION 5-100 40b	770,00
467 13000 100	SONAR ULTRASONIDOS	325,00
467 01652	ATLAS 100 - VELOCIDAD GPS	324,64
467 100.086	SENSOR velocidad	95,02



ORDENADOR BRAVO 140 PARA ATOMIZADORES



- PARA TRATAMIENTO LOCALIZADO EN ARBOLADO.
- CONTROL AUTOMÁTICO POR SENSORES DE ULTRASONIDOS.
- SIMPLE, FUNCIONAL, ECONÓMICO
- COMPENSACIÓN AUTOMÁTICA RETARDOS; APERTURA CIERRE SEGÚN VELOCIDAD (REQUIERE INSTALACIÓN DE SENSOR, NO INCLUIDO)
- POSIBILIDAD DE INTRODUCIR VELOCIDAD MANUAL TEÓRICA SIN SENSOR DE VELOCIDAD
- SALIDAS PARA PILOTAR 2 SECCIONES
- DATOS: VELOCIDAD, SUPERFICIE TRATADA, CANTIDAD DE ÁRBOLES, ESTADO DE LOS SENSORES

* COMPLETO DE CABLEADO (3M CABLE ALIMENTACIÓN, 7M CABLE SENSORES)

CÓDIGO	VÍAS	P.V.P. €
467 14221	2	750,00

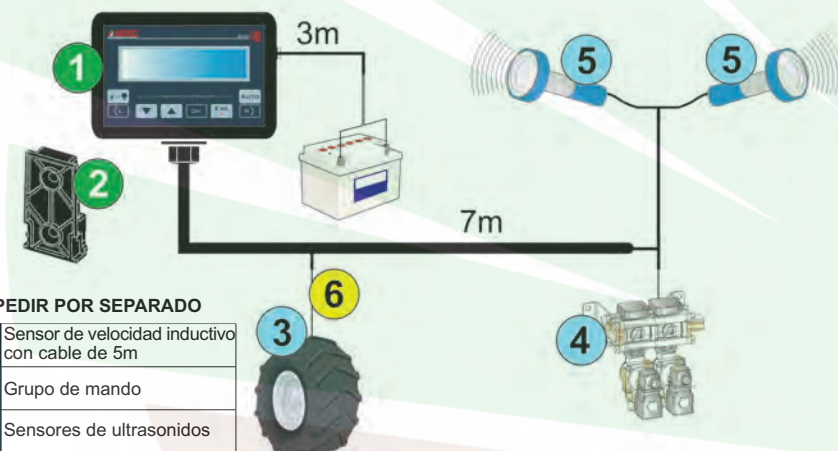

ELEMENTOS INCLUIDOS EN EL CONJUNTO DE ORDENADOR BRAVO 140 PARA ATOMIZADORES

1	Computador con cables
2	Zócalo de soporte de bayoneta
	Manual para uso y mantenimiento

ACCESORIOS

6	Prolongación para sensores 3m	COD. 466553.220
	Prolongación para sensores 5m	COD. 466553.230

A PEDIR POR SEPARADO

3	Sensor de velocidad inductivo con cable de 5m
4	Grupo de mando
5	Sensores de ultrasonidos

SENSORES PARA BRAVO 140/300S/350S DETECT

- DISTANCIA DE DETECCIÓN MÁX.6 m.
- PROTEGIDO ANTE POLVO, SUCIEDAD Y NIEBLA.
- ENTERAMENTE HERMÉTICO.
- TENSIÓN DE ALIMENTACIÓN 9 ~ 30 Vdc
- CONECTOR CON TUERCA Y PROVISTO DE TUERCAS DE AJUSTE.



CÓDIGO	P.V.P. €
467 13000 100	325,00

ELEVADOR DE TENSIÓN 12-24 Vdc

- MÓDULO PARA BRAVO-130 Y 140 PARA EL ÓPTIMO FUNCIONAMIENTO DE LOS SENSORES DE ULTRASONIDOS
- CONVERTIDOR 12/24 Vdc



CÓDIGO	P.V.P. €
467 012	150,70



GRUPOS DE MANDO “ MEDIA-ALTA PRESION”

GRIFO DISTRIBUIDOR P/ ATOMIZADOR CON VÁLVULA REGULADORA + 2 VIAS + DESCARGA DIRECTA



M 170 - BRG

DESCRIPCIÓN	CÓDIGO	P.V.P. €
CUERPO ALEACION ESPECIAL DE ELEVADA RESISTENCIA QUIMICA Y LATÓN 150 l/mn - 50 bar ENTRADA - 3/4" H SIN CODO - SALIDAS 1/2" RETORNO 1", SIN MANOMETRO	09009 1702062	210,00



UHP

DESCRIPCIÓN	CÓDIGO	P.V.P. €
ALUMINIO TRATADO ALTA RESISTENCIA QUIMICA Y LATÓN 170 l/mn - 50 bar ENTRADA - 3/4" -SALIDAS 1/2" RETORNO 1", SIN MANOMETRO	09022 461460450	205,00

VÁLVULAS REGULADORAS PRESION CONSTANTE



M 410

DESCRIPCIÓN	CÓDIGO	P.V.P. €
MAX 180 l/mn - 60 bar ENTRADA 3/4" BILATERAL RETORNO 1" INFERIOR CUERPO DE LATON	09009 411 15104	93,00



DS 2/40

DESCRIPCIÓN	CÓDIGO	P.V.P. €
MAX 100 l/mn - 40 bar ENTRADA H 1/2" SALIDA: 2 GRIFOS + MANOMETRO CUERPO ALUMINO TRATADO	09022 601 045	101,00



DL 2/40

DESCRIPCIÓN	CÓDIGO	P.V.P. €
MAX 100 l/mn - 40 bar ENTRADA H 1/2" SALIDA: 2 GRIFOS + MANOMETRO CUERPO NYLON REFORZADO	09022 614601093	90,00



VRG 150

DESCRIPCIÓN	CÓDIGO	P.V.P. €
MAX 150 l/mn - 80 bar ENTRADA 3/4 " RETORNO Ø 25 mm Toma manometro 1/4", CUERPO LATÓN	08022 001 761	140,00



GRIFOS DE BOLA

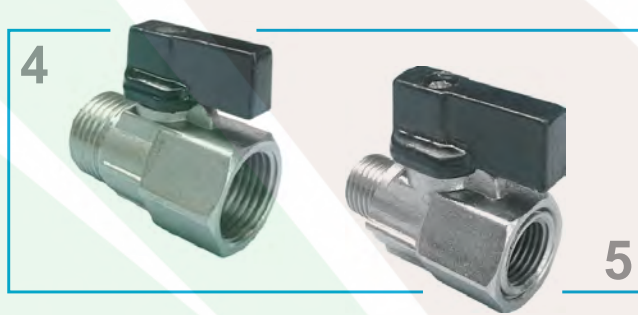
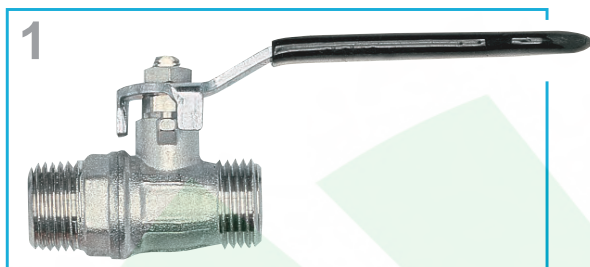

	MOD.	CÓDIGO	VÍAS	TIPO	P.V.P. €
1	ESTANDAR	09003 000 6820	2	M - M - 1/2"	7,00
2	PALANCA	11041 433 012	2	M - H - 1/2"	5,80
2	PALANCA	11041 433 412	2	H - H - 1/2"	5,30
3	MARIPOSA	11041 417 412	2	H - H - 1/2"	5,72
4	MINI	11041 400 112	2	M - H - 1/2"	5,20
4	MINI	11041 400 113	2	M - H - 3/8"	4,10
5	MINI	11041 400 114	2	M - H - 1/4"	4,80
6	3V T	09003 006 852	3	H - 1/2"	28,50
		09003 006 853	3	H - H - H - 3/4"	62,80
	3V L	09003 006 952	3	H - H - H - 1/2"	28,50
		09003 006 953	3	H - H - H - 3/4"	45,50

2022



MANOMETROS DE GLICERINA CI 1,6



CAJA ACERO INOXIDABLE Ø 63

CONEXIÓN LATÓN 1/4 " VERTICAL

CÓDIGO	ESCALA bar	P.V.P. €
106 10 0200	0...2,5	9,20
106 10 0400	0...4	
106 10 0600	0...6	
106 10 1000	0...10 **	
106 10 1600	0...16 **	
106 10 2500	0...25 *	
106 10 4000	0...40 *	
106 10 6000	0...60 *	
106 11 0000	0...100	
106 11 6000	0...160	
105 10 4000 Ø 53	0...40	9,70
206 10 1000 TOTAL INOX	0...10 **	45,00

CONEXIÓN LATÓN 1/4 " POSTERIOR

CÓDIGO	ESCALA bar	P.V.P. €
106 00 1000	0...10 **	9,70
106 00 1600	0...16 **	
106 00 4000	0...40 *	
106 00 6000	0...60 *	
106 01 6000	0...160	
104 90 4000 Ø 40 1/8"	0...40	

CAJA ACERO INOXIDABLE Ø 100

CONEXIÓN LATÓN 1/2 " VERTICAL

CÓDIGO	ESCALA bar	P.V.P. €
107 50 0400	0...4	25,90
107 50 1000	0...10**	
107 50 1600	0...16**	
107 50 2500	0...25*	
107 50 6000	0...60*	
107 51 0000	0...100	

CONEXIÓN LATÓN 1/2 " POSTERIOR

CÓDIGO	ESCALA bar	P.V.P. €
107 60 1600	0...16 **	25,90
107 60 2500	0...25 *	
107 60 6000	0...60 *	
107 60 6001	0...60	43,20
107 70 6001 1/4"	TRICOLOR	

* marca escala 1...1 / ** marca escala 0,2...0,2



MANOMETROS DE GLICERINA CI 1,6

ESCALA ISOMÉTRICA



CAJA ACERO INOXIDABLE Ø 63

CONEXIÓN LATÓN 1/4" VERTICAL Y POSTERIOR

ESCALA bar	1/4 VERTICAL	1/4 POSTERIOR	P.V.P. €
	CÓDIGO	CÓDIGO	
0...8...25	506 15 2600	506 05 2600	32,00
0...15...60	506 15 5900	506 05 5900	32,00
0...5...25	506 15 2500 WIKA	506 05 2500 WIKA	46,00
0...20...60	506 15 6000 WIKA	506 05 6000 WIKA	46,00



CAJA ACERO INOXIDABLE Ø 100

CONEXIÓN LATÓN V VERTICAL P POSTERIOR

ESCALA bar	CONEXIÓN	CÓDIGO	P.V.P. €
0...8...25	1/4" V	507 15 2600	62,00
0...15...60	1/4" V	507 15 5900	
0...5...25 cl1	1/4" V	507 15 2500 WIKA	72,00
0...20...60	1/4" V	507 15 6000 WIKA	
0...8...25	1/4" P	507 05 2400	66,00
0...15...60	1/2" P	507 65 5900	
0...5...25 cl1	1/2" V	507 55 2500 WIKA	160,00

MANÓMETRO DIGITAL



DESCRIPCIÓN	CÓDIGO	P.V.P. €
VISUALIZADOR DIGIBLOCK - CON CABLE SENSOR 3 m Y CABLE ALIMENTACION 2 m	4668 3B	131,84
SENSOR PRESION 0...20 bar	466 113.200	163,95
SENSOR PRESION 0...50 bar	466 113.500	
ALARGO CABLE SENSOR 5 m	466 553.230	26,18



DESCRIPCIÓN	CÓDIGO	P.V.P. €
VACUOMETRO DE GLICERINA 0 ..(-76 cm Hg) ESFERA Ø 63 - 1/4" VERTICAL	906 19 7600	9,30



VÁLVULAS DE BOLA ELÉCTRICAS 12Vdc

 AISI 316
BALL
TEFLON®

 AISI 316
BALL

0° → 90°

 AISI 316
BALL
TEFLON®

 AISI 316
BALL

 AISI 316
BALL
TEFLON®

 AISI 316
BALL

DESCRIPCIÓN	F (BSP)	CÓDIGO	P.V.P. €
2 VIAS VÁLVULA DE BOLA ELÉCTRICA CON TIRANTES TOMAS ROSCADAS (H hembra/ M- macho) BOLA INOX TEFLON - 1" y 1" 1/4 BOLA INOX RESTO MEDIDAS	H 1"	853K04A44	300,83
	H 1" 1/4	853K04A55	300,24
	H 1" 1/2	853K05A66	334,18
	H 2"	853K06A77	374,50
	M 2"	853K06E77	374,50
3 VIAS - LATERAL VÁLVULA DE BOLA ELÉCTRICA CON TIRANTES TOMAS LATERAL ROSCADA (H hembra/ M - macho) BOLA INOX TEFLON - 1" y 1" 1/4 BOLA INOX RESTO MEDIDAS	H 1" 1/4	853K14A55	322,51
	H 1" 1/2	853K15A66	380,86
	M 1" 1/2	853K15E66	380,86
	M 2"	853K16E77	426,48
	H 2"	853K16A77	426,48
3 VIAS - INFERIOR VÁLVULA DE BOLA ELÉCTRICA CON TIRANTES TOMA INFERIOR/ LATERAL ROSCADAS (H hembra/ M- macho) BOLA INOX TEFLON - 1" y 1" 1/4 BOLA INOX RESTO MEDIDAS	M 2"	853K26E77	426,48

CAJAS MANDO

DESCRIPCIÓN	CÓDIGO		P.V.P. €
INCLUYE CABLE ALIMENTACION 2 M + CABLE A VÁLVULA 4 M	4668 5100	1 VIA	59,00
	4668 5200	2 VIAS	87,04

DISPONIBLES OTRAS MEDIDAS Y MODELOS - SOLICITEN INFORMACION -



VÁLVULAS DE BOLA SERIE 453



PP BALL



DESCRIPCIÓN	F (BSP)	CÓDIGO	P.V.P. €
2 VIAS VÁLVULA DE BOLA CON TIRANTES TOMAS ROSCADAS (H hembra/ M - macho) - BOLA INOX - BAJO DEMANDA -	H 1" 1/4	453004A55	28,84
	H 1" 1/2	453005A66	36,05
	H 2" 1/2	45300 7A88	86,21
	H 3"	45300 7A99	86,21
	M 3"	45300 7E99	
	M 2"	45300 6E77	49,03
3 VIAS - LATERAL VÁLVULA DE BOLA CON TIRANTES TOMA LATERAL ROSCADA (H hembra/ M - macho) - BOLA INOX - BAJO DEMANDA -	H 1" 1/4	45301 4A55	37,60
	H 1" 1/2	45301 5A66	45,53
	H 2"	45301 6A77	60,56
	H 3"	45301 7A99	116,39
	M 2"	45301 6E77	60,56
	M 3"	45301 7E99	116,39
3 VIAS - INFERIOR VÁLVULA DE BOLA CON TIRANTES TOMA INFERIOR/ LATERAL ROSCADAS (H hembra/ M - macho) - BOLA INOX - BAJO DEMANDA -	H 1"	45302 4A44	37,22
	H 1" 1/4	45302 4A55	38,11
	H 1" 1/2	45302 5A66	45,32
	H 2"	45302 6A77	60,16
	H 3"	45302 7A99	114,70
	M 2"	45302 6E77	60,16
5 VIAS VÁLVULA DE BOLA CON TIRANTES TOMAS ROSCADAS (H hembra)	H 2"	45325 7A77	322,69
	H - H 2" - 3"	45325 7A97	322,69
	H 3" FULL PORT	45325 8A99	674,00
	H2" 	45345 7A97	266,77



PP BALL

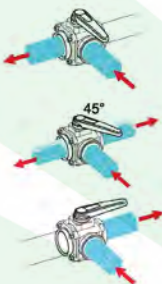

PP BALL

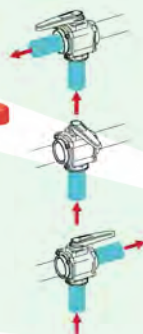

AISI 316 BALL



BOLAS DE PE-UHMW

Nuevo material polietileno de altísimo peso molecular de excepcionales características
Óptimo deslizamiento - Autolubrificante - Gran resistencia a la abrasión (superior al INOX)

- Excelente resistencia química - Peso reducido -

La mayoría de los modelos de Válvulas 453 son disponibles en esta versión.

- CONSULTAR CATALOGO TÉCNICO -

DISPONIBLES OTRAS MEDIDAS Y MODELOS - SOLICITEN INFORMACION -



VÁLVULAS DE BOLA

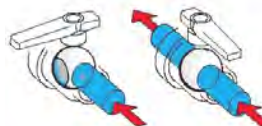

Válvula de bola 2 vías

DESCRIPCIÓN	F (BSP)	CÓDIGO	P.V.P. €
CONEXIONES ROSCA HEMBRA GAS *CUERPO PP REFORZADO CON FIBRA DE VIDRIO *JUNTAS EPDM (Viton® bajo pedido) *ASIENTOS CIERRE DE TEFLON®	G 1/2	455 11102	9,74
	G 3/4	455 11103	9,74
	G 1	455 11104	12,57
	G 1 1/4	455 11105	19,69
	G 1 1/2	455 11106	21,64
	G 2	455 11107	28,84
CONEXION ROSCA HEMBRA - CAMLOCK	G 1 1/2	455 15106	24,02
	G 2	455 15107	31,17

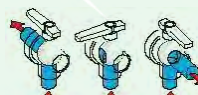

DE CORTE "L"



FLUJO CONTINUO "T"

Válvula de bola 3 vías

DESCRIPCIÓN	F (BSP)	CÓDIGO	P.V.P. €	CÓDIGO	P.V.P. €
CONEXIONES ROSCA HEMBRA GAS *CUERPO PP REFORZADO CON FIBRA DE VIDRIO *JUNTAS EPDM (Viton® bajo pedido) *ASIENTOS CIERRE DE TEFLON®	G 1/2	455 21112	13,42	455 31112	14,94
	G 3/4	455 21113	13,42	455 31113	14,94
	G 1	455 21114	16,48	455 31114	17,10
	G 1 1/4	455 21115	24,78	455 31115	26,08
	G 1 1/2	455 21116	29,01	455 31116	30,51
	G 2	455 21117	37,44	455 31117	38,96
CONEXION ROSCA HEMBRA - CAMLOCK	G 1 1/2	455 25116	31,38		
	G 2	455 25117	41,12		

Válvula de bola cierre hermetico



DESCRIPCIÓN	CÓDIGO	P.V.P. €
VÁLVULA PARA SALIDAS DE CISTERNA ELEVADA SEGURIDAD - POSIBILIDAD DE INCORPORAR CANDADO DE CIERRE HEMBRA 2" - CAMLOCK	4545 177	45,32



BAJO PEDIDO TODOS LOS MODELOS PUEDEN SUMINISTRARSE CON LEVA REALZADA PARA MONTAJE PANEL



GRIFOS - FILTROS



MICRO VÁLVULAS PP REFORZADO - MAX PRES 20 bar



CÓDIGO	DESCRIPCIÓN	ROSCAS	P.V.P. €
26 LV025MTV	GRIFO DE BOLA H 1/4" - M 1/4" 2 VIAS	NPT	17,90 €
26 LV038050MTV	GRIFO DE BOLA H 3/8" - M 1/2" 2 VIAS	NPT	18,90 €
26 LV038MTV	GRIFO DE BOLA H 3/8" - M 3/8" 2 VIAS	NPT	17,90 €
26 LV025V	GRIFO DE BOLA H 1/4" 2 VIAS	NPT	17,90 €
26 LV038V	GRIFO DE BOLA H 3/8" 2 VIAS	NPT	16,20 €
26 LV050SLV	GRIFO DE BOLA H 1/2" -3 VIAS - LATERAL	NPT	23,20 €

**VÁLVULAS DE BOLA - PP REFORZADO
MAX PRES 20 bar - 15 bar a partir 1" -**



CÓDIGO	DESCRIPCIÓN	ROSCAS	P.V.P. €
26 V050	GRIFO ESFERA H 1/2" 2 VIAS - BOLA 3/4"	BSP	43,70 €
26 V075	GRIFO ESFERA H 3/4" 2 VIAS - BOLA 3/4"	BSP	43,70 €
26 V100FPB	GRIFO ESFERA H 1" 2 VIAS - BOLA 1"	BSP	48,20 €
26 V150B	GRIFO ESFERA H 1 1/2" 2 VIAS - BOLA 1 1/2"	BSP	61,90 €
26 V200FPB	GRIFO ESFERA H 2" 2 VIAS - BOLA 1 1/2"	BSP	61,90 €
26 V300FPB	GRIFO ESFERA H 3" 2 VIAS - BOLA 3"	BSP	210,00 €
26 VRH200K	KIT MANETA extraíble p/V125/150/200	BSP	35,20 €

FILTRO L S Q - TAPA CAMLOCK APERTURA RÁPIDA -



CÓDIGO	DESCRIPCIÓN	ROSCAS	P.V.P. €
26 LSQ150-12	FILTRO LINEA INCL.M 1 1/2" INOX 12 MESH -PP	NPT	115,00 €
26 LSQ200-12	FILTRO LINEA INCL.M 2" INOX 12 MESH -PP	NPT	115,00 €
26 LS2120	CARTUCHO FILTRO LSQ 120 MESH - NEGRO		48,50 €
26 LS220	CARTUCHO FILTRO LSQ 20 MESH - MARFIL		48,50 €
26 LS250	CARTUCHO FILTRO LSQ 50 MESH - AZUL		48,50 €



CONSULTAR PARA OTROS MODELOS Y GAMA ARTÍCULOS



FILTROS DE ASPIRACIÓN



SERIE	CAPACIDAD l.p.m.	CONEXIÓN	MALLA Mesh	CÓDIGO	P.V.P. €
310	60	1" 1/4	18	310 2057	10,40
			32	310 2058	
		1" 1/4 LARGA	50 INOX	310 2053	
			50 INOX	310 2153	
312	60 - 100	1" 1/4	16	312 2057	12,66
			32	312 2058	
			32 INOX	312 2052	
			50 INOX	312 2053	
		1"1/4 LARGA	50 INOX	312 2153	12,66
313	80 - 120	1" 1/4	50 INOX	313 2053	21,11
314	100 - 160	1" 1/4	50 INOX	314 2053	25,36
			50 INOX	314 2153	
		1" 1/2	32 INOX	314 2062	25,36
			50 INOX	314 2063	
316	160 - 220	1" 1/2	32 INOX	316 2062	34,32
			50 INOX	316 2063	
		1" 1/2 LARGA	50 INOX	316 2163	34,32
		2"	32 INOX	316 2072	
			50 INOX	316 2073	
2" LARGA	50 INOX	316 2173			

2022



FILTROS DE ASPIRACION CON VÁLVULA



SERIE	CAPACIDAD l.p.m.	CONEXIÓN	MALLA Mesh	CÓDIGO	P.V.P. €
313	80 - 120	1" 1/4	32 INOX	313 2452	30,09
			50 INOX	313 2453	
		1" 1/4 LARGA	50 INOX	313 2553	



314	100 - 160	1" 1/4	50 INOX	314 2453	34,11
		1" 1/4 LARGA	50 INOX	314 2553	34,11
		1" 1/2	32 INOX	314 2462	34,11
			50 INOX	314 2463	
		80 INOX	314 24635		
1"1/2 LARGA	50 INOX	314 2563			



316	160 - 220	1" 1/2	32 INOX	316 2462	45,45	
			50 INOX	316 2463		
		1" 1/2 LARGA	50 INOX	316 2563		
		2 "	32 INOX	316 2472		45,45
			50 INOX	316 2473		
2" LARGA	50 INOX	316 2573				



317	200 - 260	2"	50 INOX	317 2473	49,99
-----	-----------	----	---------	----------	--------------

2022



FILTROS DE ASPIRACION GRAN CAPACIDAD



SERIE	CAPACIDAD l.p.m.	CONEXIÓN	MALLA Mesh	CÓDIGO	P.V.P. €
317	200 / 260	2"	50 (Inox)	317 2073	40,04
			32 (Inox)	317 2172	
		2" LARGA	50 (Inox)	317 2173	40,04
			80 (Inox)	317 21735	
		2" 1/2	32 (Inox)	317 2082	48,70
			50 (Inox)	317 2083	



SERIE	CAPACIDAD l.p.m.	CONEXIÓN	MALLA Mesh	CÓDIGO	P.V.P. €
319	400 / 800	3"	32 (Inox)	319 092	71,09
			50 (Inox)	319 093	

ROSCA PURGA 1" CERRADA PARA TOMA AUTOLIMPIANTE

2022



FILTROS ASPIRACIÓN - CONEXIONES "T"



CÓDIGO	SERIE	CAPACIDAD l.p.m.	CONEXIONES	MALLA (Mesh)	P.V.P. €
31620F3	316	160-220	T7	50 (Inox)	34,32
31620E3			T6	50 (Inox)	34,32
31420E3	314	100-160	T6	50 (Inox)	25,36
31320E3	313	80-120	T6	50 (Inox)	21,11

FILTROS ASPIRACIÓN - CONEXIONES "T"



CÓDIGO	SERIE	CAPACIDAD l.p.m.	CONEXIONES	MALLA (Mesh)	P.V.P. €
31624E3	316	160-220	T6	50 (Inox)	45,45
31424E3	314	100-160	T6	50 (Inox)	34,11



TABLA MEDIDAS CONEXIONES			
TIPO	pasaje ≈	T=mm	T=mm
T4	1"	35.4	37.7
T5	1" 1/4	44.5	46
T6	1" 1/2	50	54
T7	2"	60	64.5
T9	3"	89.2	94.3

OTROS ATRTICULOS Y MEDIDAS CONSULTAR PRECIOS Y DISPONIBILIDADES



COMUNICACIÓN IMPORTANTE

ARAG, ha unificado los colores de los cartuchos filtrantes de acuerdo a la norma **ISO 19732:2007**, ya vigente.

Para facilitar el reconocimiento de los filtros **ARAG** ha decidido marcar los cartuchos con la indicación de los Mesh correspondientes y colocar en el exterior del cuerpo del filtro otra identificación del mismo color del cartucho para identificar fácilmente el nivel de filtrado. En la tabla se puede comprobar, además de los datos de filtrado la correspondencia entre el color anterior y el nuevo color **ISO 19732**.

MESH = número de hilos por pulgada (25,4 mm)

A = abertura útil de pasaje

Ø = diámetro del hilo

S = relación de porcentaje entre la superficie de las aberturas y la superficie total de la red

M = material

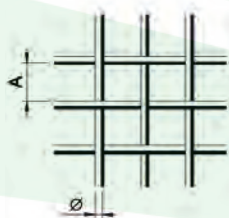

		ISO 19732				
Vecchio colore Old colour Color viejo	Nuovo Colore New colour Nuevo color	MESH	A (microns)	Ø (microns)	S (%)	M
BLACK	BROWN RED	16	980	490	44.4	Polypropylene
		16	1320	220	73.3	Inox
WHITE	RED	32	500	320	37.1	Polypropylene
		32	594	200	55.3	Inox
LIGHT BLUE	BLUE	50	365	140	50.8	Inox
GRAY	YELLOW	80	229	80	55.7	Inox
RED	GREEN	100	173	80	46.4	Inox
GREEN	GRAY (non ISO)	120	134	70	43	Poliammide
		120	144	70	45.4	Inox
ORANGE	ORANGE	150	96	65	35	Poliammide
		150	114	60	42.4	Inox
YELLOW	PINK	200	80	50	37	Poliammide
		200	76	50	36.2	Inox

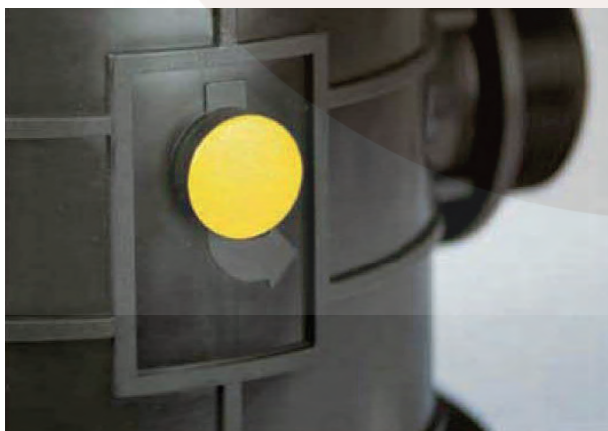



CARTUCHOS PARA FILTROS ASPIRACION - RECAMBIOS

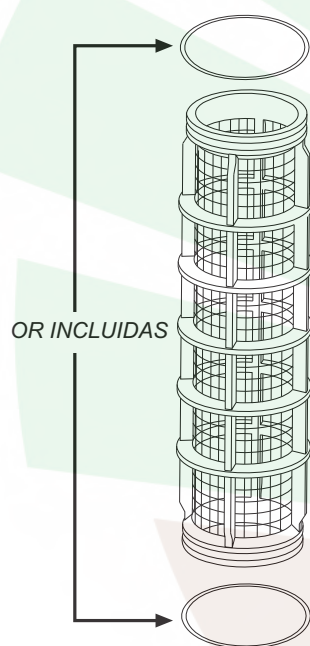

MODELO DEL FILTRO	DIMENSIONES mm	TIPO	CÓDIGO	P.V.P. €
310	Ø70 x 100	INOX 32 MESH	310 202.030	6,00
		INOX 50 MESH	310 203.030	
		POLI. 16 MESH	310 207.030	
		POLI. 32 MESH	310 208.030	
312	Ø70 x 150	INOX 32 MESH	312 202.030	7,25
		INOX 50 MESH	312 203.030	
		POLI. 16 MESH	312 207.030	
		POLI. 32 MESH	312 208.030	
313	Ø79 x 109	INOX 32 MESH	318 202.030	10,83
		INOX 50 MESH	318 203.030	
		INOX 80 MESH	318 2035.030	
314	Ø78 x 167	INOX 32 MESH	314 202.030	11,58
		INOX 50 MESH	314 203.030	
		INOX 80 MESH	314 235.030	
		INOX 100 MESH	314 2040.030	
316	Ø108 x 200	INOX 32 MESH	316 202.030	15,13
		INOX 50 MESH	316 203.030	
317	Ø108 x 286	INOX 100 MESH	316 2040.030	18,18
		INOX 32 MESH	317 202.030	
		INOX 50 MESH	317 203.030	
319	Ø145 x 320	INOX 80 MESH	317 2035.030	30,41
		INOX 32 MESH	335 202.030	
		INOX 50 MESH	335 203.030	
		INOX 80 MESH	335 235.030	
		INOX 100 MESH	335 204.030	32,03
				32,03
				34,30

2022



RELACION MEDIDAS ELEMENTOS FILTRO DISPONIBLES

CÓDIGO	DESCRIPCION-MEDIDAS - MESH
32420035.030	CARTUCHO 27X69 AMARILLO (80MESH)
3242003.030	CARTUCHO 27X69 AZUL (50MESH)
3242002.030	CARTUCHO 27X69 ROJO (32MESH)
3242004.030	CARTUCHO 27X69 VERDE (100MESH)
32320035.030	CARTUCHO 38X122 AMARILLO (80MESH)
3232003.030	CARTUCHO 38X122 AZUL (50MESH)
3232005.030	CARTUCHO 38X122 GRIS (120MESH)PA
3232006.030	CARTUCHO 38X122 NARANJA(150MESH)PA
3232002.030	CARTUCHO 38X122 ROJO (32MESH)
3232004.030	CARTUCHO 38X122 VERDE (100MESH)
32220035.030	CARTUCHO 38X89 AMARILLO (80MESH)
3222003.030	CARTUCHO 38X89 AZUL (50MESH)
3222002.030	CARTUCHO 38X89 ROJO (32MESH)
3222004.030	CARTUCHO 38X89 VERDE (100MESH)
32520035.030	CARTUCHO 50X150 AMARILLO (80MESH)
3252003.030	CARTUCHO 50X150 AZUL (50MESH)
3252005.030	CARTUCHO 50X150 GRIS (120MESH)PA
3252006.030	CARTUCHO 50X150 NARANJA(150MESH)PA
3252002.030	CARTUCHO 50X150 ROJO (32MESH)
3252004.030	CARTUCHO 50X150 VERDE (100MESH)
32620035.030	CARTUCHO 58X210 AMARILLO (80MESH)
3262003.030	CARTUCHO 58X210 AZUL (50MESH)
3262002.030	CARTUCHO 58X210 ROJO (32MESH)
3262004.030	CARTUCHO 58X210 VERDE (100MESH)
3102003.030	CARTUCHO 70X100 AZUL (50MESH)
3102007.030	CARTUCHO 70X100 MARRON (16MESH)PP
3102002.030	CARTUCHO 70X100 ROJO (32MESH)
3102008.030	CARTUCHO 70X100 ROJO (32MESH) PP
31220035.030	CARTUCHO 70X150 AMARILLO (80MESH)
3122003.030	CARTUCHO 70X150 AZUL (50MESH)
3122005.030	CARTUCHO 70X150 GRIS (120MESH)PA
3122007.030	CARTUCHO 70X150 MARRON (16MESH)PP
3122006.030	CARTUCHO 70X150 NARANJA(150MESH)PA
3122002.030	CARTUCHO 70X150 ROJO (32MESH)
3122008.030	CARTUCHO 70X150 ROJO (32MESH) PP
3122004.030	CARTUCHO 70X150 VERDE (100MESH)
32920035.030	CARTUCHO 70X220 AMARILLO (80MESH)
32922035.030	CARTUCHO 70X220 AMARILLO 80M/32M
3292003.030	CARTUCHO 70X220 AZUL (50MESH)
3292005.030	CARTUCHO 70X220 GRIS (120MESH)PA
3292205.030	CARTUCHO 70X220 GRIS 120M/32M
3292206.030	CARTUCHO 70X220 NARANJA 150M/32M
3292006.030	CARTUCHO 70X220 NARANJA(150MESH)PA
32922065.030	CARTUCHO 70X220 ROSA 200M/32M
3292004.030	CARTUCHO 70X220 VERDE (100MESH)
3292204.030	CARTUCHO 70X220 VERDE 100M/32M

CÓDIGO	DESCRIPCION-MEDIDAS - MESH
31420035.030	CARTUCHO 78X167 AMARILLO (80MESH)
3142003.030	CARTUCHO 78X167 AZUL (50MESH)
3142002.030	CARTUCHO 78X167 ROJO (32MESH)
31820035.030	CARTUCHO 79X109 AMARILLO (80MESH)
3182003.030	CARTUCHO 79X109 AZUL (50MESH)
3182002.030	CARTUCHO 79X109 ROJO (32MESH)
333105.030	CARTUCHO 97X276 (120MESH)
333106.030	CARTUCHO 97X276 (150MESH)
31620035.030	CARTUCHO 108X200 AMARILLO (80MESH)
3162003.030	CARTUCHO 108X200 AZUL (50MESH)
3162002.030	CARTUCHO 108X200 ROJO (32MESH)
31720035.030	CARTUCHO 108X286 AMARILLO (80MESH)
31722035.030	CARTUCHO 108X286 AMARILLO 80M/32M
3172003.030	CARTUCHO 108X286 AZUL (50MESH)
3172205.030	CARTUCHO 108X286 GRIS 120M/32M
3172206.030	CARTUCHO 108X286 NARANJA 150M/32M
3172002.030	CARTUCHO 108X286 ROJO (32MESH)
31722065.030	CARTUCHO 108X286 ROSA 200M/32M
3172004.030	CARTUCHO 108X286 VERDE (100MESH)
3172204.030	CARTUCHO 108X286 VERDE 100M/32M
33222035.030	CARTUCHO 130X375 AMARILLO 80M/32M
3322003.030	CARTUCHO 130X375 AZUL (50MESH)
3322205.030	CARTUCHO 130X375 GRIS 120M/32M
3322206.030	CARTUCHO 130X375 NARANJA 150M/32M
3322002.030	CARTUCHO 130X375 ROJO (32MESH)
33222065.030	CARTUCHO 130X375 ROSA 200M/32M
3322204.030	CARTUCHO 130X375 VERDE 100M/32M
33422035.030	CARTUCHO 130X556 AMARILLO 80M/32M
3342003.030	CARTUCHO 130X556 AZUL (50MESH)
3342205.030	CARTUCHO 130X556 GRIS 120M/32M
3342206.030	CARTUCHO 130X556 NARANJA 150M/32M
3342002.030	CARTUCHO 130X556 ROJO (32MESH)
33422065.030	CARTUCHO 130X556 ROSA 200M/32M
3342204.030	CARTUCHO 130X556 VERDE 100M/32M
33520035.030	CARTUCHO 145X320 AMARILLO (80MESH)
33522035.030	CARTUCHO 145X320 AMARILLO 80M/32M
3352003.030	CARTUCHO 145X320 AZUL (50MESH)
3352205.030	CARTUCHO 145X320 GRIS 120M/32M
335105.030	CARTUCHO 145X320 LAMIERA 120MESH
335106.030	CARTUCHO 145X320 LAMIERA 150MESH
3352206.030	CARTUCHO 145X320 NARANJA 150M/32M
3352002.030	CARTUCHO 145X320 ROJO (32MESH)
33522065.030	CARTUCHO 145X320 ROSA 200M/32M
3352004.030	CARTUCHO 145X320 VERDE (100MESH)
3352204.030	CARTUCHO 145X320 VERDE 100M/32M

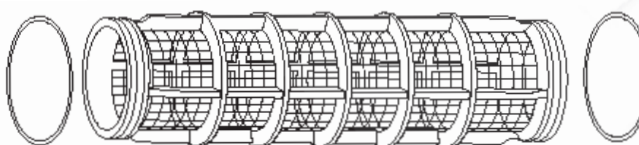

OR INCLUIDAS



FILTRO DE ASPIRACIÓN FLOTANTE - MALLA INOX -

ASEGURA LA ASPIRACION SIEMPRE POR DEBAJO DEL NIVEL A RAS DE AGUA



CÓDIGO	DESCRIPCIÓN	Ø mm	P.V.P. €
307 3030	FILTRO COMPLETO	30	33,99
307 3040		40	
307 3050.200	ADAPTACION INTERCAMBIABLE	50	2,27
307 3060.200		60	

FILTROS ASPIRACIÓN DE FONDO



DESCRIPCIÓN	D EXTERIOR X ALTURA mm	Ø CONEXIÓN mm	CÓDIGO	P.V.P. €
PIÑA DE ASPIRACION ORIFICIOS RETICULARES CRUZADOS TOTAL ASPIRACION EN CUALQUIER POSICION	61 X 47	19	302 019	2,44
	100 x 57	20	302 120	1,96
		25	302 125	
	125 x 76	25	302 225	2,68
		30	302 230	
	150 x 96	30	302 330	4,02
		35	302 335	
		40	302 340	
		50	302 350	4,12



FILTRO FONDO MALLA 32 MESH	42 x 65	19	305 110	4,22
		25	305 120	
	70 x 130	ROSCA M 3/4"	305 231	7,31

FILTRO ACERO CHAPA PERFORADA	100 X 70	17	306 017	19,74
		23	306 023	
	100 X 150	25-30	306 125	23,76



FILTRO EN "T" MALLA 16 Mesh CONEXIONES ROSCADAS	110 X 130	M 1" 1/4	304 251	9,95
	110 X 200	M 1" 1/2	304 361	13,09
		M 2"	304 371	13,32



FILTROS EN LINEA BAJA PRESIÓN



Repuesto	
COD.	Tipo
322 2002.030	Inox 32 mesh
322 2003.030	Inox 50 mesh
322 20035.030	Inox 80 mesh
322 2004.030	Inox 100 mesh



CUERPO PP - MALLA INOX Ø 38 x 89 mm - MAX PRESION 14 bar



MODELO	CAPACIDAD l/mn	CONEXIONES	MALLA INOX MESH	CÓDIGO	P.V.P. €
322 - 2	80 -100	M 1/2"	32	322 2022	10,93
			50	322 2023	
		M 3/4"	100	322 2024	
			50	322 2033	
324 - 2	80 -100	H 1/2"	100	322 2034	10,93
			32	324 2022	
		H 3/4"	50	324 2023	
			80	324 20235	
			100	324 2024	
			50	324 2033	
			100	324 2034	



CUERPO PP con INSERTOS FIJACION LATON - MALLA INOX Ø 38 x 125 mm - MAX PRESION 12 bar

MODELO	CAPACIDAD l/mn	CONEXIONES	MALLA INOX MESH	CÓDIGO	P.V.P. €
323	80 -140	M 1/2"	32	323 022	15,25
			50	323 023	
			100	323 024	
		M 3/4"	32	323 032	15,25
			50	323 033	
			100	323 034	
M 1"			32	323 042	15,25
			50	323 043	
			100	323 044	



CUERPO PP - MALLA INOX Ø 38 x 125 mm - MAX PRESION 14 bar

MODELO	CAPACIDAD l/mn	CONEXIONES	MALLA INOX MESH	CÓDIGO	P.V.P. €
324 - 4	150 - 160	H 1"	32	324 4042	14,82
			50	324 4043	
			100	324 4044	
322 - 4		M 1"	100	322 4044	14,78
			50	322 4043	

2022



FILTROS EN LINEA BAJA PRESION



		Ricambio Spare part Repuesto
COD. CODE CÓD.		Tipo di rete Screen type Tipo de red
3262002.030	Red	Inox 32 mesh
3262003.030	Blue	Inox 50 mesh
32620035.030	Yellow	Inox 80 mesh
3262004.030	Green	Inox 100 mesh



CUERPO PP - MALLA INOX Ø 58 X 210 mm - MAX PRESION 15bar

MODELO	CAPACIDAD l/mn	CONEXIONES	MALLA INOX MESH	CÓDIGO	P.V.P. €
326	200 - 280	M 1" 1/4	50	326 2053	28,47
			100	326 2054	
		M 1" 1/2	32	326 2062	
			50	326 2063	
328	200 - 280	H 1" 1/4	50	328 2053	29,97
			100	328 2054	
		H 1" 1/2	100	328 2064	

FILTRO EN LINEA VASO NYLON TRANSPARENTE



		Repuesto
COD.		Tipo
324 2002.030	Red	Inox 32 mesh
324 2003.030	Blue	Inox 50 mesh
324 2004.030	Green	Inox 100 mesh



CUERPO PP - MALLA INOX Ø 27 X 69 mm - MAX PRESION 10 bar

MODELO	CAPACIDAD l/mn	CONEXIONES	MALLA INOX MESH	CÓDIGO	P.V.P. €
324 - 0T	55	H 1/2"	32	324 0T022	11,36
			50	324 0T023	
			100	324 09024	
324 OPACO	55	H 1/2"	50	324 0023	9,41
			100	324 0024	



FILTROS EN LINEA BAJA PRESION AUTOLIMPIANTES



Repuesto	
CÓD.	Tipo
326 2002.030	Inox 32 mesh
326 2003.030	Inox 50 mesh
326 20035.030	Inox 80 mesh
326 2004.030	Inox 100 mesh



CUERPO PP - MALLA INOX Ø 58 X 210 mm - MAX PRESION 15 bar

MODELO	CAPACIDAD l/mn	CONEXIONES	MALLA INOX MESH	CÓDIGO	P.V.P. €
328-2	200-280	H 1 " 1/4	80	328 21535	37,70
		H 1 " 1/2	100	328 2164	
326 - 2		M 1" 1/4	50	326 2153	34,61
		M 1" 1/4	80	326 21535	
		M 1" 1/2	50	326 2163	



Repuesto	
CÓD.	Tipo
323 2002.030	Inox 32 mesh
323 2003.030	Inox 50 mesh
323 20035.030	Inox 80 mesh
323 2004.030	Inox 100 mesh



CUERPO PP - MALLA INOX Ø 38 X 125 mm - MAX PRESION 14 bar

MODELO	CAPACIDAD l/mn	CONEXIONES	MALLA INOX MESH	CÓDIGO	P.V.P. €
324 -4	150 - 160	H 1"	50	324 4143	20,60
		H 1"	80	324 41435	
322 - 4		M 1"	50	322 4143	20,60
		M 1"	100	322 4144	

2022



FILTROS LINEA ALTA PRESION DE NYLON REFORZADO



SERIE 345 - 50 bar

DESCRIPCIÓN	CÓDIGO	TIPO MALLA	P.V.P. €
CAPACIDAD 150 l/mn - 50 bar *CONEXIONES DOBLES IN-OUT G 3/4" Y G 1/2"	345 033	50 Mesh	39,35
*CUERPO NAYLON REFORZADO CON FIBRA DE VIDRIO *CARTUCHO Ø 50 X 150 mm *OR estanqueidad vaso de VITON® *GRIFO AUTOLIMPIEZA INCLUIDO	345 0335	80 Mesh	39,35



SERIE 3452 - 50 bar

DESCRIPCIÓN	CÓDIGO	TIPO MALLA	P.V.P. €
CAPACIDAD 150 l/mn - 50 bar *CONEXIONES BRIDA 463/471 *CUERPO NAYLON REFORZADO CON FIBRA DE VIDRIO *CARTUCHO Ø 50 X 150 mm *OR estanqueidad vaso de VITON® FIJADA AL VASO *GRIFO AUTOLIMPIEZA INCLUIDO	3452 0030	50 Mesh	32,34



SERIE 322 2A - 30 bar

DESCRIPCIÓN	CÓDIGO	TIPO MALLA	P.V.P. €
CAPACIDAD 80-100 l/mn - 30 bar *CONEXIONES 1/2" M *CUERPO NAYLON REFORZADO CON FIBRA DE VIDRIO *CARTUCHO Ø 38 X 89 mm *JUNTAS EPDM	322 2A 023	50 Mesh	13,80

RECAMBIOS

MODELO	CÓDIGO	DESCRIPCIÓN	P.V.P.€
345 /3452	325 2002.030	CARTUCHO Ø 50 X 150 - 32 mesh Rojo	6,28
	325 2003.030	CARTUCHO Ø 50 X 150 - 50 mesh Azul	
	325 20035.030	CARTUCHO Ø 50 X 150 - 80 mesh Amarillo	
	325 2004.030	CARTUCHO Ø 50 X 150 - 100 mesh Verde	
	G11 010V	OR VASO 345	3,50
	G 11 038V	OR VASO 3452	5,00
322 2A	322 2002.030	CARTUCHO Ø 38 X 89 - 32 mesh Rojo	5,08
	322 2003.030	CARTUCHO Ø 38 X 89 - 50 mesh Azul	
	322 2035.030	CARTUCHO Ø 38 X 89 - 80 mesh Amarillo	
	322 2004.030	CARTUCHO Ø 38 X 89 - 100 mesh Verde	
	322 000.040	O.R.CUERPO 322 - 51 X 3,5	0,60

2022



FILTROS EN LINEA DE LATÓN - 50 Bar

SUPER 330

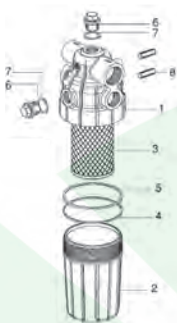

DESCRIPCIÓN	CÓDIGO	P.V.P. €
SUPER CENTRAL FILTRANTE 330 CAPACIDAD 320 l/mn - 50 bar CARTUCHO INOX DOBLE MALLA REFORZADO 50 MESH *CONEXIONES IN-OUT 1" - 3/4" *ALOJAMIENTOS PARA TOMAS MANOMETRO DIFERENCIAL *CONEXION INFERIOR AUTOLIMPIANTE *PESO 3,55 KG	11.350 400	211,00

INTREPRESS



DESCRIPCIÓN	CÓDIGO	P.V.P. €
FILTRO DISTRIBUIDOR 120 -IN CAPACIDAD 120 l/ mn - 50 bar CARTUCHOS 50 y 100 Mesh TOMAS H 1/2" CONEXION INFERIOR PARA AUTOLIMPIANTE PESO 1,1 KG	11.350 000 - 50 mesh	79,00
	11.350 001 - 100 mesh	79,00

UNIX



DESCRIPCIÓN	CÓDIGO	P.V.P. €
FILTRO EN LINEA CAPACIDAD 120 l/mn - 50 bar CARTUCHOS 50 y 100 Mesh TOMAS H 1/2" CONEXION INFERIOR PARA AUTOLIMPIANTE PESO 0,9 KG	11.350 100 - 50 mesh	76,00
	11.350 101 - 100 mesh	76,00

RECAMBIOS

MODELO	POS	CÓDIGO	DESCRIPCIÓN	P.V.P.€
SUPER 330	3	350110 000	CARTUCHO Ø 69 X 175 - 50 MESH	29,40
	4	35017 0000	O.R.VASO Ø 85 X 2,5	0,70
	5	35018 0000	O.R. CUERPO Ø 90 X 3	0,75
INTERPRESS UNIX	3	35003 0000	OR VASO Ø 49,2 X 3,53	0,36
	4	323003031	CARTUCHO Ø 38 X 125 - 50 Mesh	8,10
	4	323004031	CARTUCHO Ø 38 X 125 - 100 Mesh	8,10
		48002305	O.R. CARTUCHO 33,05 X 1,78	0,12
	2	35002 0000	VASO INFERIOR	38,00



FILTROS EN LINEA DE LATÓN - 50 Bar

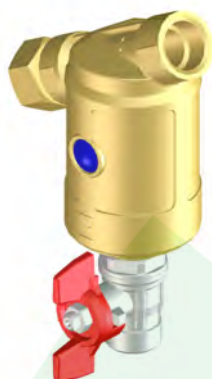

KOMPACT M146



DESCRIPCIÓN	CÓDIGO	P.V.P. €
FILTRO COMPACTO CAPACIDAD 70 l/mn - 50 Bar CARTUCHO INOX 40 Mesh CONEXIONES H 1/2" GRIFO AUTOLIMPIANTE PESO 0,65 KG	09.14650410	39,00

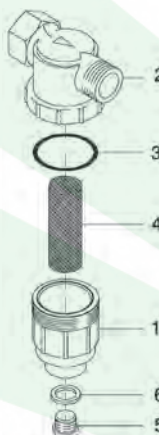

ESTÁNDAR 42

DESCRIPCIÓN	CÓDIGO	P.V.P. €
MINI FILTRO CAPACIDAD 42 l/mn - 50 Bar CARTUCHO INOX 50 Mesh CONEXIONES M-H 1/2" TOMA INFERIOR 1/4" CON TAPON PESO 0,3 KG	11.350 200	22,50



SIMPLEX 35

DESCRIPCIÓN	CÓDIGO	P.V.P. €
FILTRO LINEA REDUCIDO FACIL INSTALACION y LIMPIEZA CAPACIDAD 35 l/mn - 50 Bar CARTUCHO INOX 50 Mesh CONEXIONES 1/2 " M-H PESO 0,2 KG	11.350 300	16,00

RECAMBIOS

MODELO	POS	CÓDIGO	DESCRIPCIÓN	P.V.P.€
KOMPACT 146	4	146203 160	CARTUCHO Ø 40 X 63-40 Mesh	13,00
	4	146203 220	CARTUCHO Ø 40 X 63-100 Mesh	13,00
KOMPACT 70	4	3501 50000	CARTUCHO Ø 34,5 X 80 mm	17,00
	3	3501 60000	O.R. TAPA Ø 42,5 X 3	0,65
ESTÁNDAR 42	4	35000 5000	CARTUCHO Ø 17,5 X 52 mm	3,00
	3	G10061	OR VASO Ø 29 X 3	0,44
SIMPLEX 35	4	35000 6000	CARTUCHO Ø 16 X 46 mm	3,50
	3	05001009918052	OR UNION Ø 18 X 3	0,15



FILTROS DE MALLA P/RIEGO. SERIES 335 - 333

- GRAN CAPACIDAD FILTRANTE
- CUERPO POLIPROPILENO
- ALOJAMIENTOS ROSCADOS P/MANÓMETROS (CERRADOS)
- ROSCA DE PURGA (ABIERTA) - 1" (335) - 3/4" (333)
- TAPONES NO INCLUIDOS
- PRES. MÁX. 8 bar - 3", 10 bar - 2"



**SERIE 335 - MALLA - Ø 145 x 320 mm
ABRAZADERA INOX.**

L.p.m. m³/h	F (BSP)	MALLA	CÓDIGO	P.V.P. €
800 46	M 3"	32 (Inox)	335 2092	128,77
		50 (Inox)	335 2093	
		100 (Inox)	335 2094	
		120 (Poliester)	335 2195	150,38



SERIE 333 - MALLA - Ø 107 x 286 mm

L.p.m. m³/h	F (BSP)	MALLA	CÓDIGO	P.V.P. €
380 23	M 2"	32 (Inox)	333 2072	73,20
		50 (Inox)	333 2073	
		100 (Inox)	333 2074	
		120 (Poliester)	333 2175	88,58

SERIE 335

POS	CÓDIGO	Mesh
1	335 2090.010	---
2	335 2002.030	32
2	335 2003.030	50
2	335 20035.030	80
2	335 2004.030	100
2	335 22035.030	80/32
2	335 2204.030	100/32
2	335 2205.030	120/32
2	335 2206.030	150/32
2	335 22065.030	200/32
2A	335 105.030	120
2A	335 106.030	150
3	335 000.060	---
4	335 000.050	---
5	335 2000.020	---
6	332 000.040	---
7	335 100.031	---
8	335 105.032	120
8	335 106.032	150

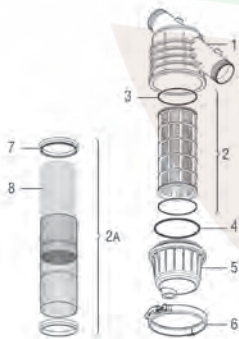

SERIE 333

POS	CÓDIGO	Mesh
1	333 2070.010	---
2	317 2002.030	32
2	317 2003.030	50
2	317 20035.030	80
2	317 2004.030	100
2	317 22035.030	80/32
2	317 2204.030	100/32
2	317 2205.030	120/32
2	317 2206.030	150/32
2	317 22065.030	200/32
2A	333 105.030	120
2A	333 106.030	150
3	G11046	---
4	333 000.050	---
5	333 2000.020	---
6	333 2000.040	---
7	333 100.031	---
8	333 105.032	120
8	333 106.032	150

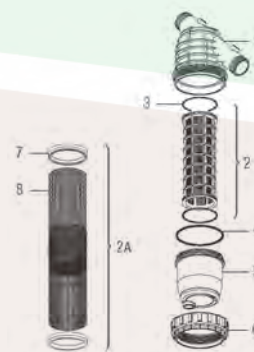



FILTROS DE MALLA Y DISCO P/RIEGO. SERIES 329 - 327-325

- GRAN CAPACIDAD FILTRANTE
- CUERPO POLIPROPILENO
- ROSCA DE PURGA (ABIERTA) - SIN TAPÓN
- PRES. MÁX. 10 bar

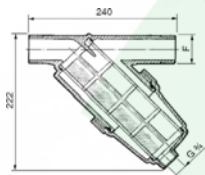

SERIE 329 - MALLA - Ø 70 x 220 mm

m³/h	F (BSP)	MALLA	CÓDIGO	P.V.P. €
10	M 2"	50 (Inox)	329 073	25,33
		100 (Inox)	329 074	
	M 1 1/2"	50 (Inox)	329 063	22,94
		100 (Inox)	329 064	
		120 (Poliamida)	329 065	

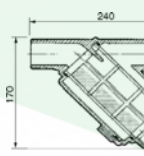

SERIE 327 - MALLA - Ø 70 x 148 mm

m³/h	F (BSP)	MALLA	CÓDIGO	P.V.P. €
9	M 1 1/4"	50 (Inox)	327 053	18,18
		100 (Inox)	327 054	
		120 (Poliamida)	327 055	

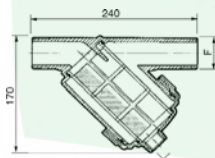
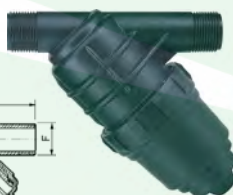

SERIE 325 - MALLA - Ø 50 x 150 mm

m³/h	F (BSP)	MALLA	CÓDIGO	P.V.P. €
6	M 1"	50 (Inox)	325 043	9,74
		100 (Inox)	325 044	
		120 (Poliamida)	325 045	11,02
		150 (Poliamida)	325 146	
		*SIN ROSCA DE PURGA		
5	M 1" DISCO	ANILLAS 130 MICRON	325 545	17,92

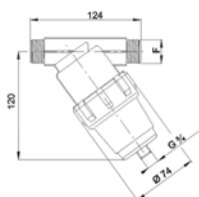

SERIE 323 - MALLA - Ø 38 x 125 mm

m³/h	F (BSP)	MALLA	CÓDIGO	P.V.P. €
	M 1/2"	50 INOX	*323 223	9,74
		120 POLIAM	*323 225	
5	M 3/4"	50 INOX	*323 233	9,74
		100 INOX	*323 234	
		120 POLIAM	*323 235	
		150 POLIAM	*323 236	
		* SIN ROSCA DE PURGA (DESCARGA)		
5	M 1/2"	120 POLIAM	323 325	10,50
	M 3/4"	100 INOX	323 334	

SOLICITEN CATÁLOGO TÉCNICO. OTROS MODELOS Y TIPOS DE MALLA DISPONIBLES



FILTRO DE MALLA 3 VÍAS SERIE 334 - 3"



**FILTRO DE MALLA 3 VIAS SERIE 334
FILTRO EN LINEA ROSCAS DE 3 "
CAPACIDAD FILTRANTE - 60 m³/h**

- * 3" - 60 m³/h - cartucho 131 x 556 mm
- * DOBLE TOMA 1/4" PARA MEDIDA PRESIÓN DIFERENCIAL
- * PRESION MAX. 10 bar
- * BRIDA INOX
- * TOMA PARA DESCARGA 1" 1/4 M CON TAPÓN
- * TAPÓN CIERRE SUPERIOR 3" INCLUIDO

OTRAS TOMAS DISPONIBLES:

- * 2" - 48 m³/h - CARTUCHO 131 X 556 mm



CÓDIGO	MESH	P.V.P.€
334 092 G3	32	223,85
334 093 G3	50	
334 2935 G3	80/32	223,85
334 294 G3	100/32	
334 295 G3	120/32	
334 296 G3	150/32	
334 2965 G3	200/32	

2022

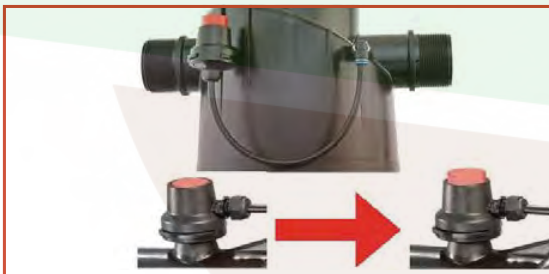

OPCIONAL

INDICADOR DE OBSTRUCCION POR DIFERENCIA DE PRESION ENTRE ENTRADA Y SALIDA

CÓDIGO	P.V.P.€
645 100	14,82

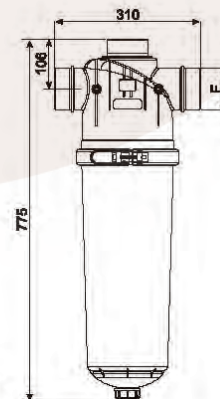
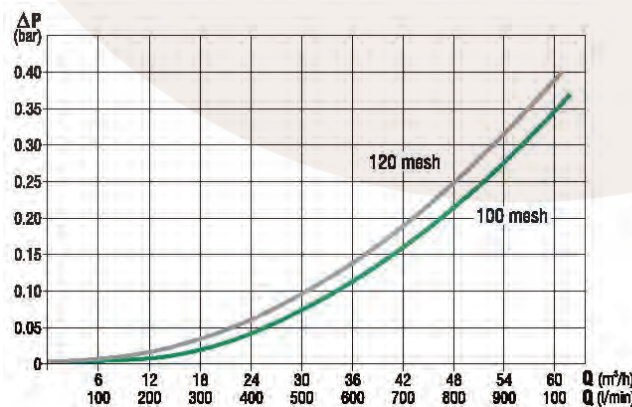



FILTRO DE MALLA AUTO LIMPIANTE MANUAL



FILTRO DE MALLA AUTO-LIMPIANTE DE GRAN CAPACIDAD PARA EMPLEO EN LIMPIEZA DE AGUAS RESIDUALES INCLUSO CONTENIENDO CIERTA CANTIDAD DE ARENA DONDE SEA NECESARIO UN FILTRAJE SIN INTERRUPCIONES.

SIN NECESIDAD DE DESMONTAJE, ES SUFICIENTE ABRIR EL GRIFO DE DESCARGA Y GIRAR LA MANIVELA PARA RECUPERAR EL PODER DE FILTRAJE.

TUBO SCANNER INTERNO CON SISTEMA DE DECANTACION QUE GARANTIZA UN PROLONGADO PERIODO DE TRABAJO ENTRE LIMPIEZAS.

- * 3" - 60 m³/h - cartucho 131 x 556 mm
- * 2" - 40 m³/h - cartucho 131 x 375 mm
- * DOBLE TOMA 1/4" PARA MEDIDA PRESIÓN DIFERENCIAL
- * PRESIÓN MAX. 10 bar
- * BRIDA INOX
- * GRIFO DESCARGA 1" 1/4 H
- * KIT DE SEÑALIZACION OBSTRUCCIÓN INCLUIDO

CÓDIGO	MESH	P.V.P.€
334 394 G3	100/32	426,48
334 395 G3	120/32	
334 396 G3	150/32	
332 374 G2	100/32	358,58
332 375 G2	120/32	
332 376 G2	150/32	

PRESIÓN MÍNIMA DE LAVADO 2 bar. CON PRESION INFERIOR INSTALAR VÁLVULA DE BOLA GRIFO EN LINEA INFERIOR AL FILTRO PARA MANTENER LA PRESIÓN.

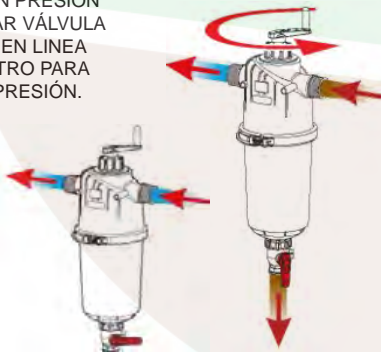

INDICADOR DE OBSTRUCCION POR DIFERENCIA DE PRESION ENTRE ENTRADA Y SALIDA

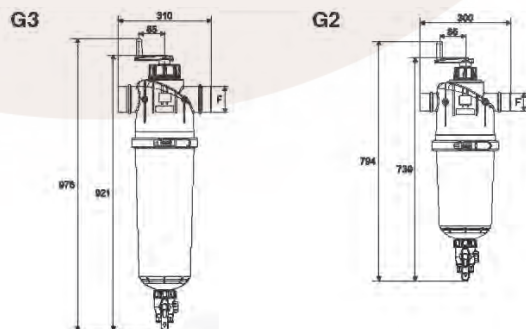
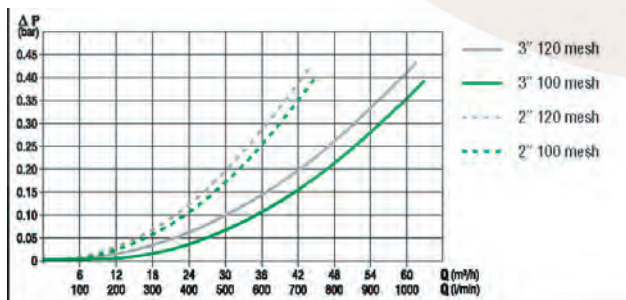

2022



ACOPLES RAPIDOS CON BLOQUEO A LEVAS

- Compatibles con los acoples MIL-C-27487.
- Levas de bloqueo en Acero Inoxidable para una máxima resistencia mecánica y a la corrosión.
- El material utilizado, Polipropileno reforzado con Fibra de Vidrio, asegura una óptima resistencia mecánica y también a los agentes químicos.
- Bajo pedido, están disponibles en Nylon reforzado con Fibra de Vidrio.
- Roscas disponibles GAS (NPT s/pedido).
- Las versiones con rosca GAS Hembra, incorporan el asiento cónico para la estanqueidad con Junta Tórica.
- Presión de trabajo máx. 9bar para modelos de 1/2" a 2" y 5 bar para modelos de 3".
- Juntas de estanqueidad en EPDM (En Viton y en NBR bajo pedido).
- Bajo pedido están disponibles los 'Muelles Bloqueadores' para prevenir aperturas accidentales de las levas en caso de vibraciones excesivas o golpes.



A ACOPLE MACHO / ROSCA HEMBRA

CÓDIGO	CUERPO	F (GAS)	P.V.P. €
181 03A2	3/4"	1/2"	2,49
181 03A	3/4"	3/4"	2,49
181 04A	1"	1"	2,49
181 05A	1 1/4"	1 1/4"	2,49
181 06A5	1 1/2"	1 1/4"	2,92
181 06A	1 1/2"	1 1/2"	2,92
181 07A	2"	2"	3,57
181 09A8	3"	2 1/2"	7,25
181 09A	3"	3"	7,25
181 0AA	4"	4"	11,46



C ACOPLE HEMBRA / PORTAMANGUERAS

CÓDIGO	CUERPO	Ø (mm)	P.V.P. €
181 03C2	3/4"	13	6,28
181 03C	3/4"	19	6,28
181 04C	1"	25	7,37
181 04C5	1"	32	7,37
181 05C30	1 1/4"	30	9,17
181 05C	1 1/4"	32	9,17
181 06C5	1 1/2"	32	9,20
181 06C	1 1/2"	38	9,20
181 06C40	1 1/2"	40	9,20
181 07C	2"	50	10,93
181 07C53	2"	53	10,93
181 07C55	2"	55	10,93
181 09C60	3"	60	17,10
181 09C8	3"	63	17,10
181 09C	3"	75	17,10
181 09C78	3"	78	17,10
181 09C87	3"	87	17,10
181 0AC105	4"	105	31,93



B ACOPLE HEMBRA / ROSCA MACHO

CÓDIGO	CUERPO	M (GAS)	P.V.P. €
181 03B2	3/4"	1/2"	6,37
181 03B	3/4"	3/4"	6,49
181 04B	1"	1"	7,37
181 05B	1 1/4"	1 1/4"	9,17
181 06B5	1 1/2"	1 1/4"	9,20
181 06B	1 1/2"	1 1/2"	9,20
181 07B	2"	2"	10,93
181 09B8	3"	2 1/2"	17,10
181 09B	3"	3"	16,99
181 0AB	4"	4"	33,99





ACOPLES RAPIDOS CON BLOQUEO A LEVAS



D ACOPLE HEMBRA / ROSCA HEMBRA

CÓDIGO	CUERPO	F (GAS)	P.V.P. €
181 03D2	3/4"	1/2"	6,37
181 03D	3/4"	3/4"	6,28
181 04D	1"	1"	7,37
181 05D	1 1/4 "	1 1/4 "	9,17
181 06D5	1 1/2"	1 1/4 "	9,20
181 06D	1 1/2"	1 1/2"	9,20
181 07D	2"	2"	10,93
181 09D8	3"	2 1/2"	17,10
181 09D	3"	3"	17,10
181 0AD	4"	4"	33,99



E ACOPLE MACHO / PORTAMANGUERAS

CÓDIGO	CUERPO	Ø (mm)	P.V.P. €
181 03E2	3/4"	13	2,49
181 03E	3/4"	19	2,49
181 04E	1"	25	2,49
181 04E5	1"	32	2,49
181 05E30	1 1/4"	30	2,49
181 05E	1 1/4"	32	2,49
181 06E5	1 1/2"	32	2,92
181 06E	1 1/2"	38	2,92
181 06E40	1 1/2"	40	2,92
181 07E	2"	50	3,68
181 07E53	2"	53	3,68
181 07E55	2"	55	3,79
181 09E60	3"	60	7,25
181 09E8	3"	63	7,25
181 09E	3"	75	7,25
181 09E87	3"	87	7,25
181 09E78	3"	78	7,25
181 0AE105	4"	105	11,46

F ACOPLE MACHO / ROSCA MACHO

CÓDIGO	CUERPO	M (GAS)	P.V.P. €
181 03F2	3/4"	1/2"	2,49
181 03F	3/4"	3/4"	2,49
181 04F	1"	1"	2,49
181 05F	1 1/4 "	1 1/4 "	2,49
181 06F5	1 1/2"	1 1/4 "	2,92
181 06F	1 1/2"	1 1/2"	2,92
181 07F	2"	2"	3,68
181 09F8	3"	2 1/2"	7,25
181 09F	3"	3"	7,25
181 0AF	4"	4"	11,46



G TAPON PARA ACOPLE HEMBRA

CÓDIGO	CUERPO	P.V.P. €
181 03G	3/4"	2,49
181 04G	1"	2,49
181 05G	1 1/4"	2,49
181 06G	1 1/2"	2,92
181 07G	2"	3,57
181 09G	3"	7,25
181 0AG	4"	9,10



H TAPON PARA ACOPLE MACHO

CÓDIGO	CUERPO	P.V.P. €
181 03H	3/4"	5,95
181 04H	1"	7,25
181 05H	1 1/4"	8,55
181 06H	1 1/2"	9,20
181 07H	2"	11,16
181 09H	3"	17,10
181 0AH	4"	29,71



MUELLES BLOQUEADORES

CÓDIGO	CUERPO	P.V.P. €
181 030	3/4"	2,78
181 040	1"	2,78
181 050	1 1/4"	2,78
181 060	1 1/2"	2,71
181 070	2"	4,22
181 090	3"	4,12

JUNTAS PLANAS RECAMBIO

CÓDIGO	CUERPO	P.V.P. €
181 03B.050	3/4"	0,80
181 04B.050	1"	0,95
181 05B.050	1 1/4"	1,10
181 06B.050	1 1/2"	1,25
181 07B.050	2"	1,45
181 09B.050	3"	1,95
181 0AB.050	4"	3,45



2022



ACOPLAMIENTOS RÁPIDOS BANJO - PP



A ACOPLÉ MACHO ROSCA HEMBRA



CÓDIGO	DESCRIPCIÓN	P.V.P. €
26057ASA075120	ACOPLÉ RAPIDO M 3/4" TAPA H 1/2" - POLY	6,20 €
26057ASA075140	ACOPLÉ RAPIDO M 3/4" TAPA H 1/4" - POLY	6,20 €
26057ASA075340	ACOPLÉ RAPIDO M 3/4" TAPA H 3/4" - POLY	6,20 €
26057ASA075380	ACOPLÉ RAPIDO M 3/4" TAPA H 3/8" - POLY	6,20 €
26057AB1000000	ACOPLÉ RAPIDO M 1" H 1" - BSP - POLY	6,20 €
26057AB1500000	ACOPLÉ RAPIDO M 1"1/2 H 1"1/2 - BSP - POLY	7,00 €
26057AB2000000	ACOPLÉ RAPIDO M 2" H 2" - BSP - POLY	8,30 €
26057AB3000000	ACOPLÉ RAPIDO M 3" H 3" - BSP - POLY	20,00 €

B ACOPLÉ HEMBRA ROSCA MACHO



CÓDIGO	DESCRIPCIÓN	P.V.P. €
26057B07512000	ACOPLÉ RAPIDO H 3/4" M 1/2" -NPT - POLY	14,10 €
26057B07534000	ACOPLÉ RAPIDO H 3/4" M 3/4" -NPT - POLY	14,10 €
26057BB1000000	ACOPLÉ RAPIDO H 1" M 1" - BSP - POLY	16,30 €
26057BB1500000	ACOPLÉ RAPIDO H 1"1/2 M 1"1/2 - BSP - POLY	19,00 €
26057BB2000000	ACOPLÉ RAPIDO H 2" M 2" - BSP - POLY	23,15 €
26057BB2000000	ACOPLÉ RAPIDO H 2" M 2" - BSP - POLY	23,15 €
26057BB3000000	ACOPLÉ RAPIDO H 3" M 3" - BSP - POLY	38,90 €

C ACOPLÉ HEMBRA P/MANGUERA



CÓDIGO	DESCRIPCIÓN	P.V.P. €
26057C07500000	ACOPLÉ RAPIDO H 3/4" D.19 - POLY	14,10 €
26057C10000000	ACOPLÉ RAPIDO H 1" D.25 - POLY	16,25 €
26057C12500000	ACOPLÉ RAPIDO H 1" D.32 - POLY	16,25 €
26057C15000000	ACOPLÉ RAPIDO H 1"1/2 D.38 - POLY	19,00 €
26057C20000000	ACOPLÉ RAPIDO H 2" D.50 - POLY	23,15 €
26057C30000000	ACOPLÉ RAPIDO H 3" D.75 - POLY	38,90 €

CAP TAPON HEMBRA



CÓDIGO	DESCRIPCIÓN	P.V.P. €
26057CAP100125	TAPON P/ACOPLÉ RAPIDO M 1" - POLY	15,60 €
26057CAP150000	TAPON P/ACOPLÉ RAPIDO M 1"1/2 - POLY	19,00 €
26057CAP200000	TAPON P/ACOPLÉ RAPIDO M 2" - POLY	23,15 €
26057CAP300000	TAPON P/ACOPLÉ RAPIDO M 3" - POLY	38,90 €

D90 CODO HEMBRA ROSCA HEMBRA



CÓDIGO	DESCRIPCIÓN	P.V.P. €
26057D90150000	ACOPLÉ RAPIDO H 1"1/2 H 1"1/2 - 90° - POLY	22,80 €
26057D90200000	ACOPLÉ RAPIDO H 2" - H 2" - 90° - POLY	28,30 €

D ACOPLÉ HEMBRA ROSCA HEMBRA



CÓDIGO	DESCRIPCIÓN	P.V.P. €
26057D12500000	ACOPLÉ RAPIDO H 1" H 1"1/4 - NPT - POLY	16,25 €
26057DB1000000	ACOPLÉ RAPIDO H 1" H 1" - BSP - POLY	16,25 €
26057DB1500000	ACOPLÉ RAPIDO H 1"1/2 H 1"1/2 - BSP - POLY	19,00 €
26057DB2000000	ACOPLÉ RAPIDO H 2" H 2" - BSP - POLY	23,15 €
26057DB3000000	ACOPLÉ RAPIDO H 3" H 3" - BSP - POLY	38,90 €
26057DBP075000	ACOPLÉ RAPIDO H 3/4" H 3/4" - POLY	19,50 €
26057DBP300000	ACOPLÉ RAPIDO H 3" H 3" - BSP - POLY - PARALELO	38,90 €

2022



ACOPLAMIENTOS RÁPIDOS BANJO - PP



E ACOUPLE MACHO P/MANGUERA



CÓDIGO	DESCRIPCIÓN	P.V.P. €
26057E10000000	ACOUPLE RAPIDO M 1" D.25 - POLY	7,50 €
26057E12500000	ACOUPLE RAPIDO M 1" D.32 - POLY	7,50 €
26057E15000000	ACOUPLE RAPIDO M 1"1/2 D.38 - POLY	7,50 €
26057E20000000	ACOUPLE RAPIDO M 2" D.50 - POLY	9,75 €
26057E30000000	ACOUPLE RAPIDO M 3" D.75 - POLY	25,60 €

F ACOUPLE MACHO ROSCA MACHO



CÓDIGO	DESCRIPCIÓN	P.V.P. €
26057F07500000	ACOUPLE RAPIDO M 3/4" M 3/4" - POLY	6,70 €
26057F12500000	ACOUPLE RAPIDO M 1" M 1"1/4 - POLY	7,40 €
26057FB1000000	ACOUPLE RAPIDO M 1" M 1" - BSP - POLY	7,40 €
26057FB1500000	ACOUPLE RAPIDO M 1"1/2 M 1"1/2 - BSP - POLY	7,50 €
26057FB2000000	ACOUPLE RAPIDO M 2" M 2" - BSP - POLY	9,80 €
26057FB3000000	ACOUPLE RAPIDO M 3" M 3" - POLY	25,60 €

GV JUNTAS

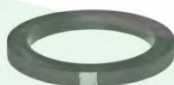

CÓDIGO	DESCRIPCIÓN	P.V.P. €
26057GV0750000	JUNTA VITON PARA ACOUPLE RAPIDO 3/4" -	12,60 €
26057GV1000000	JUNTA VITON PARA ACOUPLE RAPIDO 1"	12,30 €
26057GV1500000	JUNTA VITON PARA ACOUPLE RAPIDO 1 1/2"	12,80 €
26057GV2000000	JUNTA VITON PARA ACOUPLE RAPIDO 2"	19,90 €
26057GV3000000	JUNTA VITON PARA ACOUPLE RAPIDO 3"	27,30 €
26057GV4000000	JUNTA VITON PARA ACOUPLE RAPIDO 4"	35,60 €

K - MP-P-RING



CÓDIGO	DESCRIPCIÓN	P.V.P. €
26057K07500000	LEVA+ ANILLA P/ ACOUPLE RAPIDO 3/4" - INOX	4,30 €
26057K10000000	LEVA+ ANILLA P/ ACOUPLE RAPIDO 1" - INOX	4,10 €
26057K61502000	LEVA+ ANILLA P/ ACOUPLE RAPIDO 1 1/2" y 2" - INOX	7,00 €
26057K63000000	LEVA+ ANILLA P/ ACOUPLE RAPIDO 3" y 4" - INOX	9,30 €
26057MP300000	PASADOR ANILLA P/ ACOUPLE RAPIDO 3" y 4" - INOX	2,60 €
26057P07500000	PASADOR ANILLA P/ ACOUPLE RAPIDO 3/4" - INOX	1,00 €
26057P10000000	PASADOR ANILLA P/ ACOUPLE RAPIDO 1" - INOX	1,00 €
26057P20000000	PASADOR ANILLA P/ ACOUPLE RAPIDO 1 1/2" y 2" - INOX	1,20 €
26057RING10000	ANILLA P/ ACOUPLE RAPIDO 3/4" y 1" - INOX	1,00 €
26057RING15000	ANILLA P/ ACOUPLE RAPIDO 1/2", 2", 3" y 4" - INOX	1,20 €

PL TAPON MACHO



CÓDIGO	DESCRIPCIÓN	P.V.P. €
26057PL0750000	TAPON P/ACOUPLE RAPIDO H 3/4" - POLY	6,70 €
26057PL1500000	TAPON P/ACOUPLE RAPIDO H 1"1/2 - POLY	7,20 €
26057PL2000000	TAPON P/ACOUPLE RAPIDO H 2" - POLY	9,70 €
26057PL3000000	TAPON P/ACOUPLE RAPIDO H 3" - POLY	20,30 €

2022



ACOPLAMIENTOS CAM LOK - INOX -



A ACOPLER MACHO ROSCA HEMBRA



CÓDIGO	REF.	DESCRIPCIÓN	P.V.P. €
075ASS	26057SSA075000	ACOPLER RAPIDO M 3/4" H 3/4" - INOX	57,81 €
100ASS	26057SSA100000	ACOPLER RAPIDO M 1" H 1" - INOX	58,40 €
150ASS	26057SSA150000	ACOPLER RAPIDO M 1 1/2" H 1 1/2" - INOX	59,72 €
200ASS	26057SSA200000	ACOPLER RAPIDO M 2" H 2" - INOX	69,93 €
300ASS	26057SSA300000	ACOPLER RAPIDO M 3" H 3" - INOX	143,15 €
400ASS	26057SSA400000	ACOPLER RAPIDO M 4" H 4" - INOX	246,02 €

B ACOPLER HEMBRA ROSCA MACHO



CÓDIGO	REF.	DESCRIPCIÓN	P.V.P. €
075BSS	26057SSB075000	ACOPLER RAPIDO H 3/4" M 3/4" - INOX	87,83 €
100BSS	26057SSB100000	ACOPLER RAPIDO H 1" M 1" - INOX	100,06 €
150BSS	26057SSB150000	ACOPLER RAPIDO H 1 1/2" M 1 1/2" - INOX	121,58 €
200BSS	26057SSB200000	ACOPLER RAPIDO H 2" M 2" - INOX	143,59 €
300BSS	26057SSB300000	ACOPLER RAPIDO H 3" M 3" - INOX	271,19 €
400BSS	26057SSB400000	ACOPLER RAPIDO H 4" M 4" - INOX	368,31 €

C ACOPLER HEMBRA P/MANGUERA



CÓDIGO	REF.	DESCRIPCIÓN	P.V.P. €
075CSS	26057SSC075000	ACOPLER RAPIDO H 3/4" D.19 - INOX	85,16 €
100CSS	26057SSC100000	ACOPLER RAPIDO H 1" D.25 - INOX	87,78 €
150CSS	26057SSC150000	ACOPLER RAPIDO H 1 1/2" D.38 - INOX	105,62 €
200CSS	26057SSC200000	ACOPLER RAPIDO H 2" D.50 - INOX	129,36 €
300CSS	26057SSC300000	ACOPLER RAPIDO H 3" D.75 - INOX	208,76 €
400CSS	26057SSC400000	ACOPLER RAPIDO H 4" D.105 - INOX	340,98 €

CAP TAPON HEMBRA



CÓDIGO	REF.	DESCRIPCIÓN	P.V.P. €
075CAP/SS	26057SSCAP0750	TAPON P/ACOPLER RAPIDO M 3/4" - INOX	87,83 €
100CAP/SS	26057SSCAP1000	TAPON P/ACOPLER RAPIDO M 1" - INOX	99,98 €
150CAP/SS	26057SSCAP1500	TAPON P/ACOPLER RAPIDO M 1 1/2" - INOX	113,67 €
200CAP/SS	26057SSCAP2000	TAPON P/ACOPLER RAPIDO M 2" - INOX	111,05 €
300CAP/SS	26057SSCAP3000	TAPON P/ACOPLER RAPIDO M 3" - INOX	162,59 €
400CAP/SS	26057SSCAP4000	TAPON P/ACOPLER RAPIDO M 4" - INOX	258,98 €

PRECIOS ORIENTATIVOS - CONSULTAR OFERTA

2022



ACOPLAMIENTOS CAM LOK - INOX -



D ACOPLA HEMBRA ROSCA HEMBRA



CÓDIGO	REF.	DESCRIPCIÓN	P.V.P. €
075DSS	26057SSD075000	ACOPLA RAPIDO H 3/4" H 3/4" - INOX	88,70 €
100DSS	26057SSD100000	ACOPLA RAPIDO H 1" H 1" - INOX	95,61 €
150DSS	26057SSD150000	ACOPLA RAPIDO H 1 1/2" H 1 1/2" - INOX	121,58 €
200DSS	26057SSD200000	ACOPLA RAPIDO H 2" H 2" - INOX	133,52 €
300DSS	26057SSD300000	ACOPLA RAPIDO H 3" H 3" - INOX	273,35 €
400DSS	26057SSD400000	ACOPLA RAPIDO H 4" H 4" - INOX	369,41 €

E ACOPLA MACHO P/MANGUERA



CÓDIGO	REF.	DESCRIPCIÓN	P.V.P. €
075ESS	26057SSE075000	ACOPLA RAPIDO M 3/4" D.19 - INOX	60,29 €
100ESS	26057SSE100000	ACOPLA RAPIDO M 1" D.25 - INOX	59,05 €
150ESS	26057SSE150000	ACOPLA RAPIDO M 1 1/2" D.38 - INOX	75,38 €
200ESS	26057SSE200000	ACOPLA RAPIDO M 2" D.50 - INOX	80,57 €
300ESS	26057SSE300000	ACOPLA RAPIDO M 3" D.75 - INOX	160,41 €
400ESS	26057SSE400000	ACOPLA RAPIDO M 4" D.105 - INOX	317,95 €

F ACOPLA MACHO ROSCA MACHO



CÓDIGO	REF.	DESCRIPCIÓN	P.V.P. €
075FSS	26057SSF075000	ACOPLA RAPIDO M 3/4" M 3/4" - INOX	64,69 €
100FSS	26057SSF100000	ACOPLA RAPIDO M 1" M 1" - INOX	72,74 €
150FSS	26057SSF150000	ACOPLA RAPIDO M 1 1/2" M 1 1/2" - INOX	92,48 €
200FSS	26057SSF200000	ACOPLA RAPIDO M 2" M 2" - INOX	100,87 €
300FSS	26057SSF300000	ACOPLA RAPIDO M 3" M 3" - INOX	199,13 €
400FSS	26057SSF400000	ACOPLA RAPIDO M 4" M 4" - INOX	317,95 €

PL TAPON MACHO



CÓDIGO	REF.	DESCRIPCIÓN	P.V.P. €
075PL/SS	26057SSPL07500	TAPON P/ACOPLA RAPIDO H 3/4" - INOX	59,05 €
100PL/SS	26057SSPL10000	TAPON P/ACOPLA RAPIDO H 1" - INOX	63,23 €
150PL/SS	26057SSPL15000	TAPON P/ACOPLA RAPIDO H 1 1/2" - INOX	62,72 €
200PL/SS	26057SSPL20000	TAPON P/ACOPLA RAPIDO H 2" - INOX	73,36 €
300PL/SS	26057SSPL30000	TAPON P/ACOPLA RAPIDO H 3" - INOX	135,97 €
400PL/SS	26057SSPL40000	TAPON P/ACOPLA RAPIDO H 4" - INOX	205,74 €

PRECIOS ORIENTATIVOS - CONSULTAR OFERTA

2022



LATIGUILLOS DE POLIPROPILENO

Racor portamanguera recto para tuerca



CÓDIGO	F (BSP)	D (mm)	CÓDIGO	📦	CÓDIGO
200 2020	G 1/2	10	106 210	25	G 11060
		13	106 213	25	
200 2030	G 3/4	13	106 313	25	G 10031
		15	106 315	25	
		20	106 320	25	
200 2040	G 1	13	106 413	25	G 10041
		15	106 415	25	
		19	106 420	25	
		22	106 422	25	
200 2050	G 1 1/4	25	106 425	25	G 10051
		22	106 522	25	
		25	106 525	25	
		30	106 530	25	
200 2060	G 1 1/2	32	106 533	25	G 10061
		25	106 625	25	
		30	106 630	25	
		32	106 633	25	
		35	106 635	25	
200 2070	G 2	38	106 638	25	G 10071 (x 2)
		40	106 640	25	
		40	106 740	10	
200 2080	G 2 1/2	45	106 745	10	G 10081 (x 2)
		50	106 750	10	
200 2090	G 3	60	106 860	5	G 10091 (x 2)
		75	106 975	5	

CÓDIGO	P.V.P. €
106210	0,54
106213	0,54
106313	0,58
106315	0,65
106320	0,70
106413	0,88
106415	0,88
106420	0,88
106422	0,89
106425	0,90
106522	1,12
106525	1,08
106530	1,11
106533	1,11
106625	1,11
106630	1,13
106633	1,13
106635	1,39
106638	1,44
106640	1,44
106740	1,50
106745	1,50
106750	1,56
106860	2,38
106960	2,57
106975	2,96
265031	0,89
265054	1,46
265065	1,64
265076	1,82

Unión roscada macho para tuerca



CÓDIGO	F	M	CÓDIGO	📦	CÓDIGO
200 2030	G 3/4	G 3/8	265 031	25	PLANA G 40013
200 2050	G 1 1/4	G 1	265 054	25	G 10051
200 2060	G 1 1/2	G 1 1/4	265 065	25	G 10061
200 2070	G 2	G 1 1/2	265 076	25	G 10071 (x 2)

CÓDIGO	P.V.P. €	CÓDIGO	P.V.P. €
2002020	0,48	G 10031	0,19
2002024	0,48	G 10041	0,36
2002030	0,63	G 10051	0,40
2002040	0,69	G 10061	0,44
2002050	0,74	G 10071	0,43
2002060	1,08	G 10081	0,93
2002070	1,51	G 10091	1,00
2002080	2,02	G 11060	0,17
2002090	2,25	G 40013	0,21



RACORES CURVOS DE POLIPROPILENO

Racor portamanguera curvo para tuerca



CÓDIGO	F (BSP)	D (mm)	CÓDIGO	📦	CÓDIGO
200 2020	G 1/2	10	116 210	25	G 11060
200 2030	G 3/4	13	116 313	25	G 10031
		15	116 315	25	
		17	116 317	25	
		20	116 320	25	
200 2040	G 1	15	116 415	25	G 10041
		20	116 420	25	
		25	116 425	25	
200 2050	G 1 1/4	22	116 522	25	G 10051
		25	116 525	25	
		30	116 530	25	
		32	116 533	25	
200 2060	G 1 1/2	25	116 625	25	G 10061
		30	116 630	25	
		32	116 633	25	
		35	116 635	25	
		38	116 638	25	
		40	116 640	25	
200 2070	G 2	40	116 740	25	G 10071 (x 2)
		45	116 745	25	
		50	116 750	10	
		52	116 752	10	
		60	116 860	5	G 10081 (x 2)
200 2080	G 2 1/2	60	116 860	5	G 10081 (x 2)
200 2090	G 3	60	116 960	5	G 10091 (x 2)
		75	116 975	5	

CÓDIGO	P.V.P. €
116210	1,08
116313	1,08
116315	1,11
116317	1,11
116320	1,11
116415	1,20
116420	1,23
116425	1,43
116522	1,46
116525	1,46
116530	1,56
116533	1,56
116625	1,56
116630	1,63
116633	1,63
116635	2,03
116638	2,08
116640	2,06
116740	2,35
116745	3,30
116750	2,62
116860	3,64
116960	4,20
116975	4,87
117213	1,10
117530	2,08
117630	2,25
117635	2,25
117640	2,25
117745	2,92
117750	2,92

Racor portamanguera curvo a 45° para tuerca

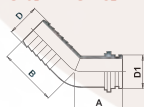

CÓDIGO	F (BSP)	D (mm)	CÓDIGO	📦	CÓDIGO
200 2020	G 1/2	13	117 213	25	G 11060
200 2050	G 1 1/4	30	117 530	10	G 10051
200 2060	G 1 1/2	30	117 630	10	G 10061
		35	117 635		
		40	117 640		
200 2070	G 2	45	117 745	10	G 10071 (x2)
		50	117 750		

CÓDIGO	P.V.P. €	CÓDIGO	P.V.P. €
2002020	0,48	G 10031	0,19
2002030	0,63	G 10041	0,36
2002040	0,69	G 10051	0,40
2002050	0,74	G 10061	0,44
2002060	1,08	G 10071	0,43
2002070	1,51	G 10081	0,93
2002080	2,02	G 10091	1,00
2002090	2,25	G 11060	0,17



LATIGUILLOS DE POLIPROPILENO

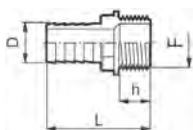

Racor portamangueras recto rosca macho

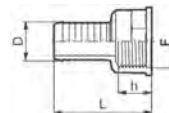

Racor portamangueras recto rosca hembra

CÓDIGO	F (BSP)	D (mm)	📦	P.V.P. €
103 2008		8	25	0,58
103 2010	G 1/4	10	25	0,58
1032013		13	25	0,58
103 2108		8	25	0,63
103 2110	G 3/8	10	25	0,63
103 2113		13	25	0,63
103 2115		16	25	0,63
103 2210		10	25	0,86
103 2213	G 1/2	13	25	0,86
103 2215		16	25	0,86
103 2220		20	25	0,93
103 2313		13	25	0,96
103 2315		16	25	0,96
103 2320	G 3/4	20	25	1,03
103 2322		22	25	1,03
103 2325		25	25	1,03
103 2420		20	25	1,13
1032422		22	25	1,13
103 2425	G 1	25	25	1,10
103 2430		30	25	1,10
103 2432		32	25	1,13
103 2520		20	25	1,25
103 2525		25	25	1,25
103 2530	G 1 1/4	30	25	1,62
103 2532		32	25	1,62
103 2535		35	25	1,63
103 2540		40	25	1,63
103 2630		30	10	1,65
1032635		35	10	1,71
103 2640	G 1 1/2	40	10	1,71
103 2645		45	10	1,71
103 2650		50	10	2,06
103 2750	G 2	50	10	2,27
103 2760		60	10	2,73
103 2860	G 2 1/2	60	10	2,96
103 2975	G 3	75	10	3,64

CÓDIGO	F (BSP)	D (mm)	📦	P.V.P. €
100 215	G 1/2	15	25	1,19
100 219		19	25	1,08
100 519		19	25	1,96
100 521		21	25	1,96
100 525		25	25	1,96
100 530	G 1 1/4	30	25	1,96
100 533		32	25	1,96
100 535		35	25	1,96
100 540		40	25	1,96
100 635		35	10	2,06
100 640	G 1 1/2	40	10	2,23
100 645		45	10	2,88
100 650		50	10	2,16
100 745		45	10	2,16
100 750	G 2	50	10	2,49
100 760		60	10	2,49



RACORES CURVOS DE POLIPROPILENO

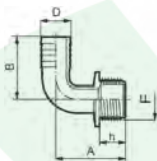

Racor portamangueras curvo 90° rosca macho

CÓDIGO	F (BSP)	D (mm)	📦	P.V.P. €
113 2113	G 3/8	13	25	1,04
113 2115		16	25	1,04
113 2213	G 1/2	13	25	1,04
113 2215		16	25	1,04
113 2220		20	25	1,04
113 2313	G 3/4	13	25	1,13
113 2315		16	25	1,13
113 2320		20	25	1,13
113 2325		25	25	1,27
113 2420	G 1	20	25	1,27
113 2425		25	25	1,28
113 2430		30	25	1,44
113 2432		32	25	1,44
113 2525		25	25	1,41
113 2530	G 1 1/4	30	25	1,54
113 2532		32	25	1,54
113 2538		38	10	1,65
113 2540		40	10	1,65
113 2630		G 1 1/2	30	10
113 2632	32		10	1,70
113 2635	35		10	2,03
113 2638	38		10	1,73
113 2640	G 2	40	10	1,73
113 2750		50	10	2,94
113 2752		52	10	2,94
113 2960	G 3	60	5	4,33
113 2975		75	5	4,33
Pasapared				
113 213L	G 1/2	13	25	1,08
113 215L	G 1/2	15	25	1,08
113 220L	G 1/2	20	25	1,08

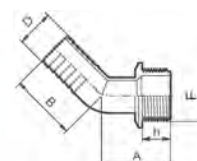

Racor portamangueras curvo 45° rosca macho y hembra

CÓDIGO	F (BSP)	D (mm)	📦	P.V.P. €
114 530	G 1 1/4	30	10	2,06
114 535		35	10	2,16
114 540		40	10	2,16
114 630	G 1 1/2	30	10	2,09
114 635		35	10	2,16
114 640		40	10	2,22
111.750	H 2	50	10	3,50

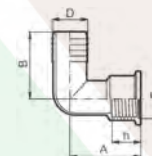

Racor portamangueras curvo 90° rosca hembra

CÓDIGO	F (BSP)	D (mm)	📦	P.V.P. €
110 2320	G 3/4	20	25	1,13
110 322		22	25	2,16
110 2325		25	25	1,20
110 330	G 1	30	25	2,23
110 2430		30	25	1,39

2022



RACORES

Racor desagüe

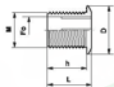

CÓDIGO	M (BSP)	h (mm)	L (mm)	D (mm)	F0 (mm)	📦	P.V.P. €
220 020	G 1/2	43	48	38	14	25	0,96
220 030	G 3/4	43	50	45	18	25	1,13
220 040	G 1"	50	55	50	25	25	1,13
220 050	G 1 1/4	40	45	58	32	25	0,82
220 052	G 1 1/4	55	60	59	32	25	0,93
220 060	G 1 1/2	46	51,5	65,5	38	25	2,02
220 070	G 2	66,5	73,5	76	47,5	10	2,22
220 080	G 2 1/2	70	76	100	63,5	10	2,87

Tuerca pasante



CÓDIGO	F (BSP)	D (mm)	h (mm)	📦	P.V.P. €
205010	G 3/8	305	13	25	0,48
2052020	G 1/2	34	13	25	0,53
2052030	G 3/4	44	13	25	0,63
2052040	G 1	50	155	25	0,69
2052050	G 1 1/4	59	143	25	0,74
2052060	G 1 1/2	67	15	25	1,12
2052070	G 2	80	195	10	1,63
2052080	G 2 1/2	100	20	10	2,02
2052090	G 3	110	22	10	2,25

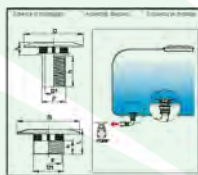

Tomas antirremolino

CÓDIGO	F	D	D1	L	h	P.V.P. €
504104	G 1"	108	25	18,5	46	4,35
504105	G 1" 1/4	108	32	18,5	46	4,90
504108	G 2" 1/2	120	63,5	30,8	56	6,46
5042106	G 1" 1/2	100	38	27	49	4,87
5042107	G 2"	120	47,5	27	56	5,52
504116	G 1" 1/2 - H	135	62	40	16	5,57

Tapón hembra



CÓDIGO	F (BSP)	📦	P.V.P. €
210005	G 1/4	25	0,44
210010	G 3/8	25	0,42
2102020	G 1/2	25	0,44
2102030	G 3/4	25	0,56
2102040	G 1	25	0,63
2102050	G 1 1/4	25	0,76
2102060	G 1 1/2	25	1,27
2102070	G 2	10	1,63
2102080	G 2 1/2	10	2,06
2102090	G 3	10	2,32

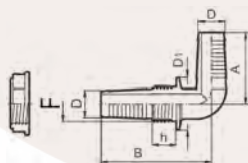

Racor pasapared de una sólo pieza curvo con tuerca

CÓDIGO	F (BSP)	D (mm)	D1 (mm)	📦	P.V.P. €
118 213	G 1/2	11	32	25	1,71
118 215	G 1/2	15	32	25	1,71
118 319	G 3/4	20	40	25	1,94
118 426	G 1	26	50	25	2,06

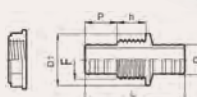

Racor pasapared de una sólo pieza recto con tuerca

CÓDIGO	F (BSP)	L (mm)	D (mm)	D1 (mm)	📦	P.V.P. €
108 425	G 1	82	25	45	25	1,81



RACORES "T"

Racor en "T" Hembra

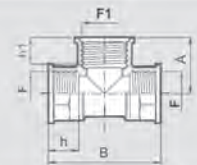

COD.	F (BSP)	F1 (BSP)	h (mm)	h1 (mm)	A (mm)	B (mm)		COD.
130 2020	G1/2	G1/2	21	21	33.5	67	25	G 10041
130 2032	G1/2	G3/4	21	23	38.5	67	25	G 10041 + G 11058
130 2030	G3/4	G3/4	23	23	38.5	77	25	G 11058
130 2023	G3/4	G1/2	23	21	38.5	77	25	G 11058 + G 10041
130 2040	G1	G1	23	23	42.5	85	10	G 11059
130 2050	G1 1/4	G1 1/4	25	25	50	100	10	G 10052
130 2060	G1 1/2	G1 1/2	25	25	52.5	105	10	G 10062
130 2070	G2	G2	28	28	62.5	125	10	G 10073



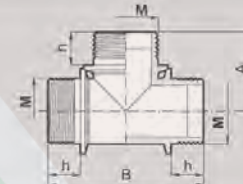

Racor en "T" Macho

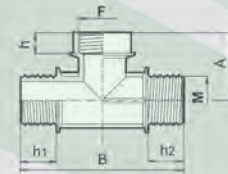

COD.	M (BSP)	h (mm)	A (mm)	B (mm)	
131 2050	G1 1/4	24	54	108	10
131 2060	G1 1/2	24	57.5	115	10
131 2070	G2	27	67.5	135	10

Racor en "T" Hembra/Macho



COD.	M (BSP)	F (BSP)	h (mm)	h1 (mm)	h2 (mm)	A (mm)	B (mm)	
132 2040	G1	G1	23	22	22	42	98	25
132 050	G1 1/4	G1 1/4	18	16	31	58.5	126	10
132 2070	G2	G2	28	27	27	67.5	135	10

Racor en "T" Macho/Hembra

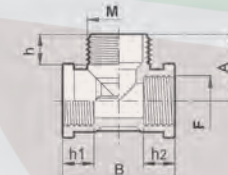

COD.	M (BSP)	F (BSP)	h (mm)	h1 (mm)	h2 (mm)	A (mm)	B (mm)	
133 024	G1	G1/2	16	17.5	17.5	35	60	25
133 034	G1	G3/4	16	16.5	16.5	35	60	25

Racor en "T" con alojamiento de fijación



COD.	DESCRIPCION
130 2090	ROSCA 3" H-H-H
132 2090	ROSCA 3" H-M-M



CÓDIGO	P.V.P. €
130 2020	1,81
130 2023	1,94
130 2030	1,94
130 2032	1,94
130 2040	2,38
130 2050	2,81
130 2060	3,46
130 2070	4,33
130 2090	8,66
131 2050	2,27
131 2060	3,04
131 2070	3,79
132 050	3,46
132 2040	4,12
132 2070	6,18
132 2090	8,66
133 024	3,04
133 034	3,04
G 10041	0,36
G 10052	0,48
G 10062	0,71
G 10073	0,91
G 10092	1,13
G 11058	0,39
G 11059	0,41

2022



RACORES CURVOS

Racor curvo 90° Macho/Macho

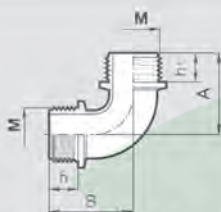

COD.	M (BSP)	h (mm)	h1 (mm)	A (mm)	B (mm)	
123 044	G1	19.5	19.5	54	54	25
123 055	G1 1/4	20.5	20.5	66.5	64.5	10
123 255	G1 1/4	23	40.5	79.5	55	10
123 2077	G2	27	27	89	89	10



Racor 45° Hembra/Macho



Racor curvo 90° Hembra/Hembra

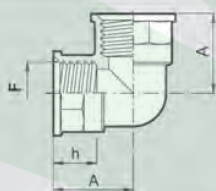

COD.	F* (BSP)	h (mm)	A (mm)		COD.
120 2022	G1/2	21	33.5	25	G 10041
120 2033	G3/4	23	38.5	25	G 11058
120 2044	G1	23	42.5	25	G 11059
120 2055	G1 1/4	25	50	10	G 10052
120 2066	G1 1/2	25	52.5	10	G 10062
120 2077	G2	28	62.5	10	G 10073
120 2099	G3	36	84.5	10	G 10092

CÓDIGO	F (BSP)	M (BSP)	A-B (mm)		
127 077	G 2	G 2	57	10	G10073

CÓDIGO	P.V.P. €
120 2022	1,21
120 2033	1,46
120 2044	1,70
120 2055	2,24
120 2066	2,49
120 2077	3,19
120 2099	6,49
123 044	1,48
123 055	1,96
123 2077	3,19
123 255	2,62
126 2022	1,25
126 2033	1,48
126 2044	1,71
126 2055	2,27
126 2066	2,49
126 2077	3,07
127 077	3,89
G 10041	0,36
G 10052	0,48
G 10062	0,71
G 10073	0,91
G 10092	1,13
G 11058	0,39
G 11059	0,41

Racor curvo 90° Macho/Hembra

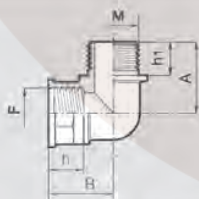

COD.	F/M* (BSP)	h (mm)	h1 (mm)	A (mm)	B (mm)		COD.
126 2022	G1/2	21	18	35	33.5	25	G 10041
126 2033	G3/4	23	22	40.5	38.5	25	G 11058
126 2044	G1	23	22	47	42.5	25	G 11059
126 2055	G1 1/4	25	24	53	50	10	G 10052
126 2066	G1 1/2	25	24	57	52.5	10	G 10062
126 2077	G2	28	27	66	62.5	10	G 10073

2022



RACORES

Racores con asiento plano para tuercas



CÓDIGO	CÓDIGO RECTO	F (BSP)	D (mm)	CÓDIGO CURVO	📦	CÓDIGO
200 010	105 108 R	G 3/8	8	xx	25	424 190
	105 110		10			
200 2020	105 210	G 1/2	10	115 210	25	G 40012
	105 213		13	xx		
200 2030	105 313	G 3/4	13	115 313	25	G 40013
	105 315		16	115 315		
	105 320		20	115 320		
200 2040	105 420	G 1	20	xx	25	G 40014
	105 425		25	115 425		
200 2050	105 530	G 1 1/4	30	115 530	25	G 40015
200 2060	105 640	G 1 1/2	40	115 640	10	G 40004

CÓDIGO	P.V.P. €
105 108	0,47
105 108 R	0,48
105 110	0,47
105 210	0,47
105 213	0,47
105 313	0,55
105 315	0,55
105 320	0,63
105 420	0,67
105 425	0,76
105 530	0,98
105 640	1,28
115 210	0,96
115 313	1,03
115 315	1,03
115 320	1,21
115 425	1,47
115 530	1,71
115 640	2,27
200 010	0,42
200 2020	0,48
200 2030	0,63
200 2040	0,69
200 2050	0,74
200 2060	1,08
424 190	0,13
G 40004	0,44
G 40012	0,17
G 40013	0,21
G 40014	0,22
G 40015	0,29

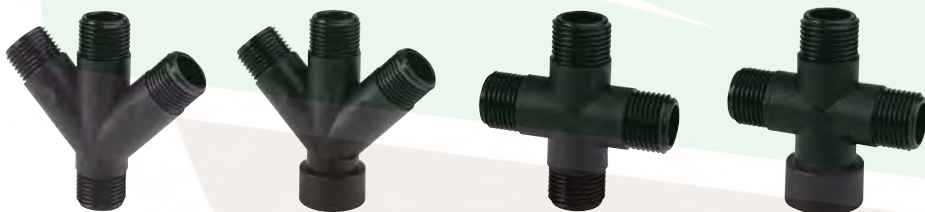

Racores 45° y 90° cuatro vías roscas G 1/2"

CÓDIGO	DESCRIPCIÓN	📦	P.V.P. €
160 020	45° - M-M-M-M	25	1,96
160 120	45° - H - M-M-M		4,43
150 020	90° - M-M-M-M		2,11
150 120	90° - H-M-M-M		2,99

CÓDIGO	DESCRIPCIÓN	P.V.P. €
140 001	RACOR "Y" ROSCA 1" M - Ø 25	4,77
152 343	COLECTOR 3 VIAS - ENTRADA 1" - SALIDAS 3/4"	6,06
152 643	COLECTOR 6 VIAS - ENTRADA 1" - SALIDAS 3/4"	6,82





UNIONES - REDUCCIONES



Unión simétrica y pasapared

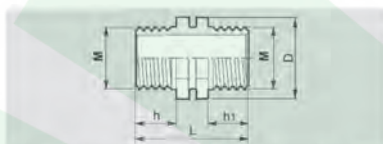

COD.	M (BSP)	h (mm)	h1 (mm)	L (mm)	D (mm)	
250 2020	G 1/2	18	18	48	32	25
250 2030	G 3/4	22	22	56	40	25
250 2040	G 1	22	22	56	45	25
250 2050	G 1 1/4	24	24	62	56	25
250 2060	G 1 1/2	24	24	62	62	10
250 2070	G 2	27	27	68	76	10
250 2080	G 2 1/2	32	32	78	92	10
250 2090	G 3	35	35	84	106	10

Pasapared

250 2021	G 1/2	38	18	68	32	25
250 2031	G 3/4	40	22	74	40	25
250 2041	G 1	45	22	79	45	25
250 2051	G 1 1/4	54	24	88	56	25
250 2061	G 1 1/2	50	24	88	62	10
250 2071	G2	50	27	91	76	10
250 2081	G2 1/2	65	32	111	92	10
250 2091	G3	73	35	122	106	10



Reducción Macho/Macho

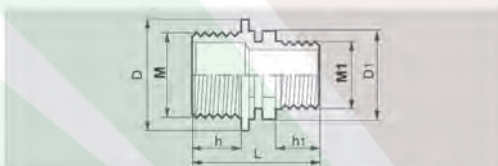

COD.	M (BSP)	M1 (BSP)	h (mm)	h1 (mm)	L (mm)	D (mm)	D1 (mm)	
240 2020	G1/2	G1/4	18	13	43	32	21	25
240 2021	G1/2	G3/8	18	16	46	32	27	25
240 2031	G3/4	G3/8	22	16	50	40	27	25
240 2032	G3/4	G1/2	22	18	52	40	32	25
240 2042	G1	G1/2	22	18	52	45	32	25
240 2043	G1	G3/4	22	22	56	45	40	25
240 2053	G1 1/4	G3/4	24	22	60	56	40	25
240 2054	G1 1/4	G1	24	22	60	56	45	25
240 2064	G1 1/2	G1	24	22	60	62	45	10
240 2065	G1 1/2	G1 1/4	24	24	62	62	56	10
240 2075	G2	G1 1/4	27	24	65	76	56	10
240 2076	G2	G1 1/2	27	24	65	76	62	10
240 2087	G2 1/2	G2	32	27	73	93	76	10
240 2097	G3	G2	35	27	78	106	76	10
240 2098	G3	G2 1/2	35	32	81	106	93	10



Manguito



COD.	F (BSP)	h (mm)	L (mm)	D (mm)	
230 2010	G3/8	17	38	27	25
230 2020	G1/2	19	43	32	25
230 2030	G3/4	23	51	40	25
230 2040	G1	23	51	45	25
230 2050	G1 1/4	25	55	56	25
230 2060	G1 1/2	25	55	62	10
230 2070	G2	28	61	76	10



Unión simple

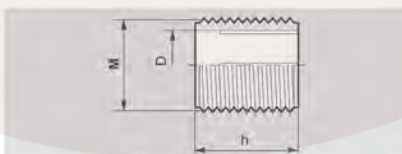

COD.	M (BSP)	h (mm)	D (mm)	
230 530	G3/4	47	18	25
230 540	G1	51	25	25
230 550	G1 1/4	33.5	32	25
230 551	G1 1/4	47.5	32	25
230 560	G1 1/2	46	38	10
230 570	G2	69	47	10

CÓDIGO	P.V.P. €
230 2010	0,92
230 2020	0,92
230 2030	1,00
230 2040	1,13
230 2050	1,73
230 2060	2,06
230 2070	2,16
230 530	2,30
230 540	0,97
230 550	1,13
230 551	1,17
230 560	1,27
230 570	1,81
240 2020	1,07
240 2021	1,07
240 2031	1,07
240 2032	1,07
240 2042	1,28
240 2043	1,29
240 2053	1,50
240 2054	1,59
240 2064	1,72
240 2065	1,77
240 2075	2,06
240 2076	2,06
240 2087	3,14
240 2097	3,25
240 2098	3,46
250 2020	0,75
250 2021	0,98
250 2030	0,85
250 2031	1,08
250 2040	0,98
250 2041	1,19
250 2050	1,50
250 2051	1,71
250 2060	1,71
250 2061	1,96
250 2070	1,98
250 2071	2,16
250 2080	2,60
250 2081	2,99
250 2090	2,99
250 2091	3,14

2022



UNIONES - REDUCCIONES

Reducción Hembra/Hembra

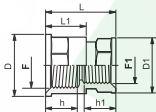

CÓDIGO	F (BSP)	F1 (BSP)	h (mm)	h1 (mm)	L (mm)	L1 (mm)	
235 2010	G3/8	G1/4	18	14	35	23	25
235 2020	G1/2	G1/4	19	14	37.5	25.5	25
235 2021	G1/2	G3/8	19	17	40.5	25.5	25
235 2031	G3/4	G3/8	23	17	44.5	29.5	25
235 2032	G3/4	G1/2	23	19	47	29.5	25
235 2042	G1	G1/2	23	19	47	29.5	25
235 2043	G1	G3/4	23	23	51	29.5	25
235 2053	G1 1/4	G3/4	25	23	53	32	25
235 2054	G1 1/4	G1	25	23	53	32	25
235 2064	G1 1/2	G1	25	23	53	32	10
235 2065	G1 1/2	G1 1/4	25	25	55	32	10
235 2075	G2	G1 1/4	28	25	58	35	10
235 2076	G2	G1 1/2	28	25	58	35	10

Reducción Macho/Hembra

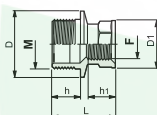

CÓDIGO	M (BSP)	F (BSP)	h (mm)	h1 (mm)	L (mm)	
245010	G3/8	G1/4	13	10	23	25
245 2032	G3/4	G1/2	22	19	47.5	25
245 2042	G1	G1/2	22	19	47.5	25
245 2043	G1	G3/4	22	23	51.5	25
245 2053	G1 1/4	G3/4	24	23	53.5	25
245 2054	G1 1/4	G1	24	23	53.5	25
245 2064	G1 1/2	G1	24	23	53.5	25
245 2065	G1 1/2	G1,1/4	24	25	56	10
245 2075	G2	G1,1/4	27	25	59	10
245 2076	G2	G1,1/2	27	25	59	10
245 2097	G3	G2	35	28	72.5	10

Reducción Hembra/Macho

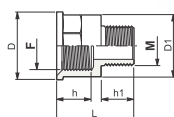

CÓDIGO	F (BSP)	M (BSP)	h (mm)	h1 (mm)	L (mm)	
245 2001	G3/8	G1/4	17	11	36	25
245 2002	G1/2	G1/4	19	13	38.5	25
245 2012	G1/2	G3/8	19	16	41.5	25
245 2013	G3/4	G3/8	23	16	45.5	25
245 2023	G3/4	G1/2	23	18	47.5	25
245 2024	G1	G1/2	23	18	47.5	25
245 2034	G1	G3/4	23	22	51.5	25
245 2035	G1,1/4	G3/4	25	22	54	25
245 2045	G1,1/4	G1	25	22	54	25
245 2046	G1,1/2	G1	25	22	54	10
245 2056	G1,1/2	G1,1/4	25	24	56	10
245 2057	G2	G1,1/4	28	24	59	10
245 2067	G2	G1,1/2	28	24	59	10
245 2079	G3	G2	27	25	60	10

Unión Hembra/Macho

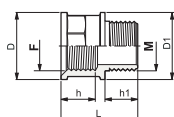

CÓDIGO	M (BSP)	F (BSP)	h (mm)	h1 (mm)	L (mm)	
245 2022	G1/2	G1/2	9	18	43.5	25
245 2033	G3/4	G3/4	23	22	51.5	25
245 2044	G1	G1	23	22	51.5	25
245 2055	G1 1/4	G1 1/4	25	24	56	25
245 2066	G11/2	G1 1/2	25	24	56	10
245 2077	G2	G2	28	27	62	10

CÓDIGO	P.V.P. €
2352010	0,92
2352020	0,92
2352021	0,97
2352031	1,03
2352032	1,03
2352042	1,14
2352043	1,14
2352053	1,72
2352054	1,72
2352064	2,06
2352065	2,06
2352075	2,17
2352076	2,17
245010	0,63
2452001	0,82
2452002	0,82
2452012	0,82
2452013	0,93
2452022	0,82
2452023	0,93
2452024	1,02
2452032	0,82
2452033	0,93
2452034	1,05
2452035	1,59
2452042	1,07
2452043	1,07
2452044	1,07
2452045	1,73
2452046	1,83
2452053	1,47
2452054	1,59
2452055	1,73
2452056	1,83
2452057	2,06
2452064	1,83
2452065	1,83
2452066	1,83
2452067	1,96
2452075	1,96
2452076	1,96
2452077	2,19
2452079	4,77
2452097	5,10

2022



TUERCAS - TAPONES



Tuerca p/racor

Tuerca pasante



COD.	F (BSP)	h (mm)	L (mm)	D (mm)	F0 (mm)	
200 010	G3/8	14	18	29	13	25
200 2020	G1/2	13	16.5	31	15.5	25
200 2024	G1/2	15	19	28.5	12.5	25
200 2030	G3/4	13.5	17	38	21.8	25
200 2040	G1	17.5	21	46	27.8	25
200 2050	G1 1/4	18	22	57	35	25
200 2060	G1 1/2	19	23.5	64	41	25
200 2070	G2	19	23.5	77	53.5	10
200 2080	G2 1/2	20	24.5	92	66	10
200 2090	G3	25.5	30	105	77	10

COD.	F (BSP)	h (mm)	D (mm)	
205 010	G3/8	13	30.5	25
205 2020	G1/2	13	34	25
205 2030	G3/4	13	44	25
205 2040	G1	15.5	50	25
205 2050	G1 1/4	14.3	59	25
205 2060	G1 1/2	15	67	25
205 2070	G2	19.5	80	10
205 2080	G2 1/2	20	100	10
205 2090	G3	22	110	10

CÓDIGO	P.V.P. €
200 010	0,42
200 2020	0,48
200 2024	0,48
200 2030	0,63
200 2040	0,69
200 2050	0,74
200 2060	1,08
200 2070	1,51
200 2080	2,02
200 2090	2,25
205 010	0,48
205 2020	0,53
205 2030	0,63
205 2040	0,69
205 2050	0,74
205 2060	1,12
205 2070	1,63
205 2080	2,02
205 2090	2,25
210 005	0,44
210 010	0,42
210 2020	0,44
210 2030	0,56
210 2040	0,63
210 2050	0,76
210 2060	1,27
210 2070	1,63
210 2080	2,06
210 2090	2,32
215 001	0,24
215 010	0,60
215 020	0,62
215 2030	0,73
215 040	0,86
215 050	1,04



Tapón hembra

Tapón macho

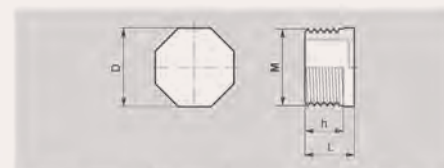
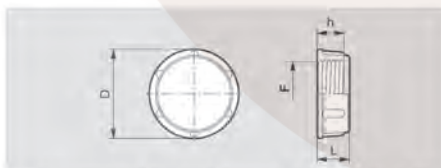

COD.	F (BSP)	h (mm)	L (mm)	D (mm)	
210 005	G1/4	7.5	10.5	19	25
210 010	G3/8	14	18	29	25
210 2020	G1/2	13	17.5	31	25
210 2030	G3/4	13.5	18	38	25
210 2040	G1	17.5	22	46	25
210 2050	G1 1/4	18	23.5	57	25
210 2060	G1 1/2	19	25	64	25
210 2070	G2	19	25.5	77	10
210 2080	G2 1/2	20	26.5	92	10
210 2090	G3	25.5	32.5	105	10

COD.	F (BSP)	h (mm)	L (mm)	D (mm)	
215 001	G1/4	9	15	17	25
215 010	G3/8	10.5	22	24	25
215 020	G1/2	15.5	23	24	25
215 2030	G3/4	17	27	29	25
215 040	G1	19	30	36	25
215 050	G1 1/4	21	27	43	25



JUNTAS

Juntas para racores portamangueras con OR

CÓDIGO	F (BSP)	D1 (mm)	S (mm)	📦
G 11057	G 3/8	9.1	2.6	50
G 11060	G 1/2	10.5	2	50
G 10031	G 3/4	13.1	2.6	50
G 10041	G 1	20.2	2.6	50
G 10051	G 1 1/4	26.7	2.6	50
G 10061	G 1 1/2	29.2	3	50
G 10071	G 2	39.3	2.6	50
G 10081	G 2 1/2	56.7	3.5	25
G 10091	G 3	68.3	3.5	10

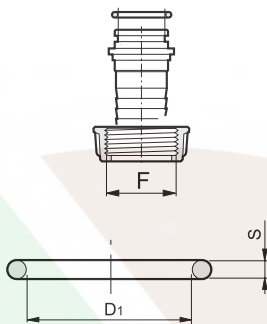

CÓDIGO	P.V.P. €
424 190	0,13
G10020	0,14
G10031	0,19
G10041	0,46
G10051	0,40
G10052	0,48
G10061	0,44
G10062	0,71
G10071	0,43
G10073	0,91
G10081	0,93
G10082	1,06
G10091	1,00
G10092	1,13
G11057	0,13
G11058	0,39
G11059	0,41
G11060	0,17
G11068	0,24
G40002	0,40
G40004	0,44
G40005	0,51
G40006	0,63
G40007	0,90
G40008	1,21
G40009	1,36
G40010	0,90
G40012	0,17
G40013	0,21
G40014	0,22
G40015	0,29

Juntas para racores con estanqueidad con OR

CÓDIGO	F (BSP)	D1 (mm)	S (mm)	📦
G 10041	G 1/2	20.2	2.6	50
G 11058	G 3/4	25	2.6	50
G 11059	G 1	29.8	2.6	50
G 10052	G 1 1/4	39.7	3.5	50
G 10062	G 1 1/2	47.2	3.5	50
G 10073	G 2	58.7	3.5	25
G 10082	G 2 1/2	74.6	3.5	25
G 10092	G 3	85.5	3.5	10

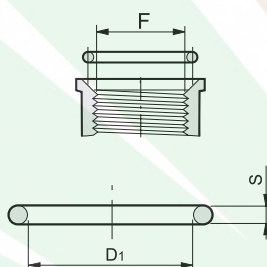

Juntas para racores portamangueras con asiento plano

CÓDIGO	F (BSP)	D (mm)	D1 (mm)	S (mm)	📦
424 190	G 3/8	14	10	2	25
G 40012	G 1/2	19.2	11.5	2.5	50
G 40013	G 3/4	24.5	17	2.5	50
G 40014	G 1	30.7	20	2.5	50
G 40015	G 1 1/4	39.5	27.5	2.5	50

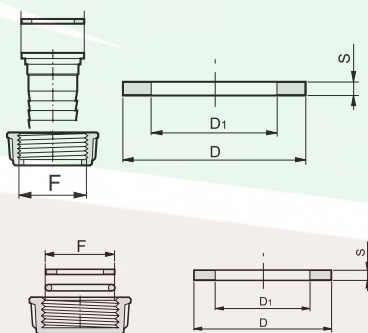

Juntas para roscas macho pasapared

CÓDIGO	M (BSP)	D (mm)	D1 (mm)	S (mm)	📦
G 40002	G 1/2	33	21	2	50
G 40003	G 3/4	39.5	27.5	2.5	50
G 40004	G 1	45	33	3	50
G 40005	G 1 1/4	60	40	4	50
G 40006	G 1 1/2	67	47	3	50
G 40007	G 2	86	59	4	25
G 40008	G 2 1/2	94.5	76	4	25
G 40009	G 3	110	90	4	25
G 40015	M24 x 2 (mm)	39.5	27.5	2.5	50

Juntas para tapones hembra

CÓDIGO	F (BSP)	D (mm)	D1 (mm)	S (mm)	📦
G 11068	G 3/8		12	2.6	50
G 10020	G 1/2		14	3	50
G 40013	G 3/4	24.5	17	2.5	50
G 40014	G 1	30.7	20	2.5	50
G 40015	G 1 1/4	39.5	27.5	2.5	50
G 40004	G 1 1/2	45	33	3	50
G 40005	G 2	60	40	4	50
G 40010	G 2 1/2	75	55	4	25
G 40007	G 3	86	59	4	25

2022



RÁCORES CON CONEXIÓN DE HORQUILLA

Portamanguera recto con conexión hembra

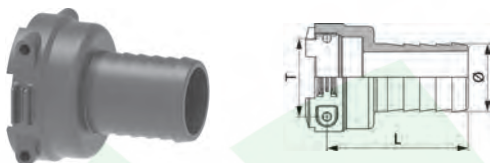

Portamanguera recto con conexión macho

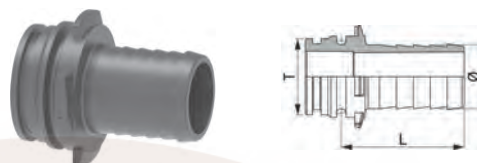

CÓDIGO	T	"Ø (mm)"	"L (mm)"		CÓDIGO
1090113	T1	13	45	25	010001
1090116		16	45	25	
1090310	T3	10	48	25	010003
1090313		13	48	25	
1090316		16	48	25	
1090320		20	53	25	
1090325		25	53	25	
1090413	T4	13	49	25	010004
1090416		16	49	25	
1090420		20	54	25	
1090425		25	54	25	
1090430	T5	30	59	25	010005
1090513		13	51	10	
1090516		16	51	10	
1090520		20	56	10	
1090525		25	56	10	
1090530		30	61	10	
1090532		32	61	10	
1090535		35	63	10	
1090538	38	69	10		
1090540	40	69	10	010006	
1090625	T6	25	60		10
1090630		30	65		10
1090632		32	65		10
1090635		35	67		10
1090638		38	73		10
1090640		40	73		10
1090650		50	81		10
1090652		52	81	10	
1090738	T7	38	77	10	010007
1090740		40	80	10	
1090745		45	82	10	
1090750		50	84	10	
1090752		52	84	10	
1090760	T9	60	93,5	10	010009
1090960		60	103	5	
1090975		75	113	5	

CÓDIGO	T	"Ø (mm)"	"L (mm)"		"COD. EPDM"	"COD. VITON®"
1091108	T1	8	30	25	G11056	G11056V
1091110A		10	35	25		
1091310		10	37	25		
1091310	T3	10	37	25	G11058	G11058V
1091313		13	39	25		
1091316		16	39	25		
1091320		20	44	25		
1091325		25	44	25		
1091330	T4	30	48	25	G11054	G11054V
1091413		13	40	25		
1091416		16	40	25		
1091420		20	45	25		
1091425	T5	25	45	25	G11063	G11063V
1091430		30	49	25		
1091513		13	40	10		
1091516		16	40	10		
1091520		20	45	10		
1091525		25	45	10		
1091530		30	50	10		
1091532		32	50	10		
1091535	35	52	10	G11023	G11023V	
1091538	38	58	10			
1091540	40	58	10			
1091625	T6	25	48			10
1091630		30	53			10
1091632		32	53			10
1091635		35	55			10
1091638		38	61			10
1091640	T7	40	61	10	G11017 x2	G11017V x2
1091650		50	68	10		
1091652		52	68	10		
1091740	T9	40	62	10	G11067 x2	G11067V x2
1091745		45	64	10		
1091750		50	69	10		
1091752		52	69	10		
1091760	T9	60	84	10	G11067 x2	G11067V x2
1091960		60	86	5		
1091975		75	96	5		

- HORQUILLAS Y JUNTAS A PEDIR POR SEPARADO -
CONSULTAR PRECIOS Y DISPONIBILIDADES



PORTAMANGUERA CURVO CON CONEXIÓN HORQUILLA

Portamanguera curvo con conexión hembra

Portamanguera curvo con conexión macho

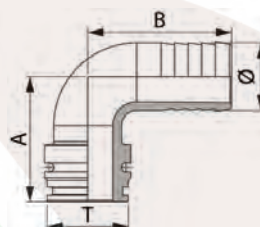
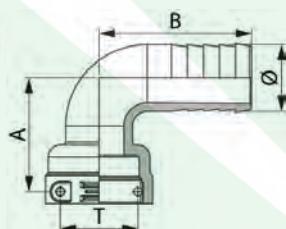

CÓDIGO	T	"Ø (mm)"	"A (mm)"	"B (mm)"	CÓDIGO
1190310	T3	10	34	35	010003
1190313		13	34	45	
1190316		16	34	48	
1190320		20	34	53	
1190325		25	43	53	
1190413	T4	13	35	45	010004
1190416		16	35	48	
1190420		20	35	53	
1190425		25	44	53	
1190430		30	45	60	25
1190513	T5	13	37	45	010005
1190516		16	37	48	
1190520		20	37	53	
1190525		25	50	57	
1190530		30	50	74	
1190532		32	50	74	
1190535		35	55	80	
1190538	38	55	85		
1190540		40	55	85	10
1190625	T6	25	54	57	010006
1190630		30	54	74	
1190632		32	54	74	
1190635		35	59	80	
1190638		38	59	85	
1190640		40	59	85	
1190650		50	71	92	
1190740	T7	40	63	85	010007
1190745		45	69	83	
1190750		50	84	92	
1190752		52	84	92	
1190760		60	99	120	
1190960	T9	60	102	120	010009
1190975		75	102	125	

CÓDIGO	T	"Ø (mm)"	"A (mm)"	"B (mm)"	"COD. EPDM"	"COD. VITON®"
1191310	T3	10	25	35	G11058	G11058V
1191313		13	25	45		
1191316		16	25	48		
1191320		20	34	53		
1191325		25	34	53		
1191413	T4	13	25	45	G11054	G11054V
1191416		16	25	48		
1191420		20	25	53		
1191425		25	34	53		
1191430		30	35	60		
1191513	T5	13	26	45	G11063	G11063V
1191516		16	26	48		
1191520		20	26	53		
1191525		25	39	57		
1191530		30	39	74		
1191532		32	39	74		
1191535		35	44	80		
1191538	38	44	85			
1191540		40	44	85	10	
1191625	T6	25	42	57	G11023	G11023V
1191630		30	42	74		
1191632		32	42	74		
1191635		35	47	80		
1191638		38	47	85		
1191640		40	47	85		
1191740		T7	40	48		
1191745	45		54	83		
1191750	50		59	92		
1191752	52		59	92		
1191760	60		79	120		
1191960	T9	60	84	120	G11067 x2	G11067V x2
1191975		75	84	125		

- HORQUILLAS Y JUNTAS A PEDIR POR SEPARADO -
CONSULTAR PRECIOS Y DISPONIBILIDADES



RÁCORES CON CONEXIÓN DE HORQUILLA

Rosca macho con conexión hembra

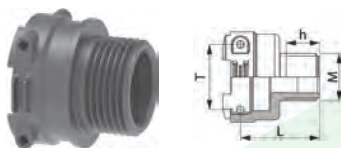

CÓDIGO	T	"M (BSP)"	"L (mm)"	"h (mm)"		CÓDIGO
249032	T3	G 1/2" M	36	18	25	010003
249033		G 3/4" M	40	22	25	
249042	T4	G 1/2" M	37	18	25	010004
249044		G 1" M	41	22	25	
249055	T5	G 1 1/4" M	46	24	10	010005
249064	T6	G 1" M	46	22	10	010006
249065		G 1 1/4" M	48	24	10	
249066		G 1 1/2" M	49	24	10	
249067		G 2" M	47	27	10	
249074	T7	G 1" M	51	22	10	010007
249075		G 1 1/4" M	53	24	10	
249076		G 1 1/2" M	53	24	10	
249077		G 2" M	59	27	10	
249099	T9	G 3" M	73	35	5	010009

Manguito hembra / hembra

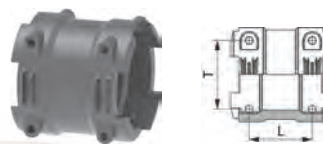

CÓDIGO	T	"L (mm)"		"h (mm)"
259011	T1	21	25	010001
259033	T3	27	25	010003
259044	T4	30	25	010004
259055	T5	32	10	010005
259066	T6	41	10	010006
259077	T7	47	10	010007
259099	T9	54	5	010009

2022

Rosca macho con conexión macho



CÓDIGO	T	"F (BSP)"	"L (mm)"	"h (mm)"		"COD. EPDM"	"COD. VITON®"
249133	T3	G 3/4" M	33	22	25	G11058	G11058V
249144	T4	G 1" M	33	22	25	G11054	G11054V
249154	T5	G 1" M	32	22	10	G11063	G11063V
249155	T5	G 1 1/4" M	37	24	10	G11063	G11063V
249166	T6	G 1 1/2" M	42	24	10	G11023	G11023V
249176	T7	G 1 1/2" M	38	24	10	G11017 x2	G11017V x2
249177	T7	G 2" M	45	27	10	G11017 x2	G11017V x2
249199	T9	G 3" M	54	35	5	G11067 x2	G11067V x2

TABLA MEDIDAS CONEXIONES

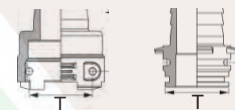

TIPO	pasaje ~ =	T=mm	T=mm
T4	1"	35.4	37.7
T5	1" 1/4	44.5	46
T6	1" 1/2	50	54
T7	2"	60	64.5
T9	3"	89.2	94.3

Manguito hembra / hembra



CÓDIGO	T	"F (BSP)"	"L (mm)"	"h (mm)"		"COD. EPDM"	"COD. VITON®"
2491331	T3	G 3/4" M	55	43	25	G11058	G11058V
2491441	T4	G 1" M	62	50	25	G11054	G11054V
2491551	T5	G 1 1/4" M	68	55	10	G11063	G11063V
2491661	T6	G 1 1/2" M	68	50	10	G11023	G11023V
2491771	T7	G 2" M	68	50	10	G11017 [2]	G110179 x2

- HORQUILLAS Y JUNTAS
A PEDIR POR SEPARADO -



RÁCORES CON CONEXIÓN DE HORQUILLA

Unión macho / macho

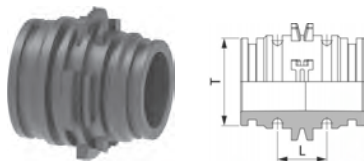

CÓDIGO	T	"L (mm)"		"COD. EPDM"	"COD. VITON®"
259133	T3	17	25	G11058	G11058V
259144	T4	19	25	G11054	G11054V
259155	T5	20	10	G11063	G11063V
259166	T6	28	10	G11023	G11023V
259177	T7	28	10	G11017 x2	G11017V x2
259199	T9	31	5	G11067 x2	G11067V x2

Reducción hembra / hembra

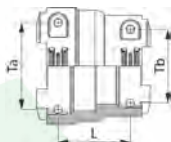

CÓDIGO	"L (mm)"		Ta	CÓDIGO	Tb	CÓDIGO
259034	29	25	T4	010004	T3	010003
259045	31	10	T5	010005	T4	010004
259056	37	10	T6	010006	T5	010005
259067	44	10	T7	010007	T6	010006
259079	51	5	T9	010009	T7	010007

TABLA MEDIDAS CONEXIONES



TIPO	pasaje ~ =	T=mm	T=mm
T4	1"	35.4	37.7
T5	1" 1/4	44.5	46
T6	1" 1/2	50	54
T7	2"	60	64.5
T9	3"	89.2	94.3

Reducción macho / macho

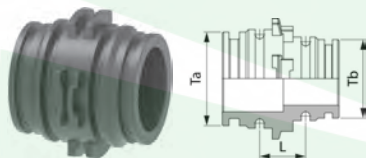

CÓDIGO	"L (mm)"		Ta	"COD. EPDM"	"COD. VITON®"	Tb	"COD. EPDM"	"COD. VITON®"
259134	19	10	T4	G11054	G11054V	T3	G11058	G11058V
259145	18	10	T5	G11063	G11063V	T4	G11054	G11054V
259156	23	10	T6	G11023	G11023V	T5	G11063	G11063V
259167	27	10	T7	G11017 x2	G11017V x2	T6	G11023	G11023V
259179	30	5	T9	G11067 x2	G11067V x2	T7	G11017 x2	G11017V x2

Tapón macho

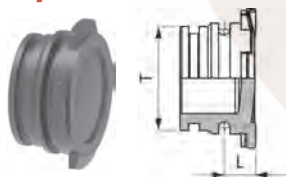

CÓDIGO	T	"L (mm)"		"COD. EPDM"	"COD. VITON®"
219130	T3	9	25	G11058	G11058V
219140	T4	10	25	G11054	G11054V
219150	T5	10	10	G11063	G11063V
219160	T6	13	10	G11023	G11023V
219170	T7	14	10	G11017 x2	G11017V x2
219190	T9	16	10	G11067 x2	G11067V x2

Tapón hembra

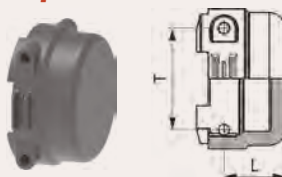

CÓDIGO	T	"L (mm)"		CÓDIGO
219010	T1	14	25	010001
219030	T3	18	25	010003
219040	T4	19	25	010004
219050	T5	21	10	010005
219060	T6	24	10	010006
219070	T7	29	10	010007
219090	T9	33	10	010009

- HORQUILLAS Y JUNTAS A PEDIR POR SEPARADO -
CONSULTAR PRECIOS Y DISPONIBILIDADES



RACORERÍA LATÓN



CÓDIGO	DESCRIPCIÓN	📦	MEDIDAS	P.V.P. €
106 100 808 00	LATIGUILLOS "Y" 3 VIAS	5	Ø 8 x 8 x 8 mm	3,80
106 101 008 00		5	Ø 10 x 8 x 8 mm	3,80
106 150 208 00	DISTRIBUIDOR	5	H 1/4" Ø 8 mm	4,60
106 150 308 00		5	M 3/8" Ø 8 mm	4,60
106 200 308 00	LATIGUILLO CON TUERCA ALETAS. JUNTA INCLUIDA	10	H 3/8" Ø 8 mm	1,75
106 200 508 00		10	H 1/2" Ø 8 mm	1,80
106 200 510 00		10	H 1/2" Ø 10 mm	1,90
106 200 512 00		10	H 1/2" Ø 12 mm	2,00
106 240 837 00	LATIGUILLO DOBLE. NO INCLUYE JUNTA		Ø 8 mm. p/T 3/8"	2,10
106 240 805 00		25	Ø 8 mm. p/T 1/2"	2,10
106 241 005 00		25	Ø 10 mm. p/T 1/2"	2,40
106 241 205 00		25	Ø 12 mm. p/T 1/2"	2,40
106 241 605 00		25	Ø 16 mm. p/T 1/2"	2,65
106 241 607 00		25	Ø 16 mm. p/T 3/4"	3,50
106 250 80 500	LATIGUILLO ESTÁNDAR. JUNTA INCLUIDA	25	Ø 8 mm	1,10
106 251 005 00		25	Ø 10 mm	1,10
106 251 205 00		25	Ø 12 mm	1,30
106 190 120 18	JUNTA NYLON STANDAR	50	STANDAR	0,15
106 262 508 00	LATIGUILLO ROSCA	10	1/4" BSP Ø 8 mm	1,96
106 260 312 00		10	3/8" BSP Ø 12 mm	1,96
106 260 508 00		10	1/2" BSP Ø 8 mm	1,30
106 260 510 00		10	1/2" BSP Ø 10 mm	1,30
106 260 512 00		10	1/2" BSP Ø 12 mm	1,30
106 300 808 00	EMPALME REFORZADO	10	Ø 8 mm	1,66
106 301 010 00		10	Ø 10 mm	2,19
106 301 212 00		10	Ø 12 mm	2,70
106 301 616 00		10	Ø 16 mm	4,46

2022



RACORERÍA LATÓN

CÓDIGO	DESCRIPCIÓN		MEDIDAS	P.V.P. €
106 310 808 00	EMPALME STANDAR	10	Ø 8 mm	0,70
106 311 010 00		10	Ø 10 mm	0,80
106 360 510 00	CODO CON TUERCA. JUNTA INCLUIDA	10	1/2" BSP Ø 10 mm	3,60
106 360 512 00		10	1/2" BSP Ø 13 mm	4,00
106 360 716 01		10	3/4" BSP Ø 16 mm	9,76
106 370 805 00	CODO SIN TUERCA. JUNTA INCLUIDA	10	1/2" BSP Ø 8 mm	2,70
106 371 005 00		10	1/2" BSP Ø 10 mm	2,85
106 371 305 00		25	1/2" BSP Ø 13 mm	3,10
106 320 808 00	ENLACE COMBINADO	10	Ø 8 mm	4,80
106 321 010 00		10	Ø 10 mm	4,80
106 110 500 00	RÁCOR "Y"	5	M 1/2" BSP	5,45
106 120 200 00	RACOR "Y" (TUERCA ALETAS)	5	M 1/2" BSP	6,25



2022



RACORERÍA LATÓN

2022



CÓDIGO	DESCRIPCIÓN	📦	MEDIDAS	P.V.P. €
106 400 500 00	UNIÓN LATÓN REFORZADA - M UNIÓN LATÓN REFORZADA - M	25	M 1/2"-1/2" BSP	2,10
106 400 510 00		10	M 1/2"-1/2" BSP ESPECIAL LARGA	3,90
106 400 750 00		25	H 3/4"-3/4"	4,21
106 410 375 00	UNION LATÓN - M	25	M 3/8"-3/8" BSP	1,12
106 410 500 00		25	M 1/2"-1/2" BSP	1,30
106 410 750 00		25	M 3/4"-3/4" BSP	2,10
106 411 000 00		5	M 1"-1"	3,25
106 411 250 00		5	M 1 1/4"-1 1/4" BSP	4,80
106 411 500 00		5	M 1 1/2"-1 1/2" BSP	5,20
106 430 503 00	REDUCCIÓN LATÓN - M REFORZADA y ESTANDAR	25	M 1/2"-3/8" BSP	3,00
106 430 705 00		25	M 1/2"-3/4" BSP	3,45
106 431 207 00		5	M 3/4"-1 1/4" BSP	4,90
106 431 012 00		5	M 1"-1 1/4" BSP	4,20
106 431 510 00		5	M 1"-1 1/2" BSP	8,55

CÓDIGO	DESCRIPCIÓN	📦	MEDIDAS	P.V.P. €
300 014 014	UNION ESPECIAL REFORZADA	10	M-1/4 " - M 1/4"	2,10
902 562 082	CROMADA 31 mm c/exagonal	5	M 1/4" - M 3/8 "larga	3,30
300 000 018	LISA 34 mm	5	M 1/4" - M 3/8 "	2,75
603 001 700	LARGA 54 mm	5	H 1/4 " - M 3/8"	3,80
300 000 200	LARGA 61 mm + INT 1/4"	5	M 1/4 - M 3/8" - int H 1/4"	6,20



RACORERÍA LATÓN

CÓDIGO	DESCRIPCIÓN	📦	MEDIDAS	P.V.P. €	
106 502 50025	JUNTA RÁCORD	GOMA 3/4"	25	16 x 23 x 2 mm	0,11
106 502 500 20		GOMA 1/2"	100	11 x 18 x 2 mm	0,07
106 231 101 30		COBRE 1/2"	10	13 x 18 x 2 mm	0,82
106 111 101 20		ALUMINIO	100	21 x 25 x 2 mm	0,18
9106 231 1012		COBRE	10		
106 280 500 00	TUERCA y TUERCA C/ BORDES		50	1/2" Ø8/10/12 mm	0,92
106 280 510 00			25	1/2" Ø 16 mm	1,17
106 280 750 00			25	3/4" Ø 16 mm	1,93
106 281 200 00			10	1 1/4"	2,07
106 281 500 00			10	1 1/2"	3,10
106 290 303 00	TUERCA ALETAS		25	H 3/8"	0,82
106 290 500 00			25	H 1/2"	0,82
106 500 500 00	MANGUITO - H		25	H 1/2"	2,62
106 500 375 00			10	H 3/8"	1,63
106 520 370 00	TAPON HEMBRA		25	H 3/8"	0,71
106 520 500 00			25	H 1/2"	0,89
106 530 500 00	TAPON MACHO		25	M 1/2"	1,07
106 530 375 00			25	M 3/8"	0,93
106 530 250 00			25	M 1/4"	1,02
106 440 250 00	REDUCCIÓN LATÓN M - H		25	H 1/4"- M 1/4"	1,54
106 450 103 00			25	H 1/4"- M 1/8"	0,90
106 460 502 00			25	* H 1/4"- M 1/2"	1,52
106 450 503 60			25	H 3/8" - M 1/2"	1,21
106 450 705 00		* ARO REDUCIDO	25	H 1/2"- M 3/4"	2,60
106 450 305 00			25	H 1/2"- M 3/8"	1,43
106 460 302 00			25	* H 1/4" - M 3/8"	1,60
106 450 203 00			25	H 3/8" - M 1/4"	1,52



2022



RACORERÍA LATÓN

2022



CÓDIGO	DESCRIPCIÓN	📦	MEDIDAS	P.V.P. €
106 330 505 00	CODO M - H 90°	25	90° M-H 1/2" BSP	5,80
0100 0330 106	CODO M - H 90°. STANDAR	10	90° M-H 3/4" BSP	5,80
106 340 505 00	CODO M - M 90°	25	90° M-M 1/2" BSP	5,80
090 017 020 17		-	90° M-M 3/4" BSP	7,45
106 350 505 00	CODO M - M 45°	25	45° M-M 1/2" BSP	3,95
106 540 500 00	CODO H - H 90°	5	90° H-H 1/2" BSP	2,90
106 540 375 00		5	90° H-H 3/8" BSP	1,90
106 380 500 00	RACOR EN "T" H - H - H	10	H 1/2" BSP	5,60
106 380 750 00		-	H 3/4"	5,60
106 395 050 00	DISTRIBUIDOR 5 SALIDAS	-	H 1/2" BSP	20,30
106 550 500 00	KIT ENLACE DESMONTABLE	10	M-H 1/2"	8,90



ABRAZADERAS



CÓDIGO	DESCRIPCIÓN	MEDIDAS	P.V.P. €
906 610 911 00	ABRAZADERAS DOS OREJAS PRECIOS NETOS. LOTE MINIMO 50 UNIDADES	9 / 11	0,14
906 611 315 00		13 / 15	0,19
906 611 417 00		14 / 17	0,29
906 611 518 00		15 / 18	0,26
906 611 720 00		17 / 20	0,26
906 611 821 00		18 / 21	0,29
906 612 023 00		20 / 23	0,32
906 612 225 00		22 / 25	0,34
906 612 528 00		25 / 28	0,40
906 612 831 00		28 / 31	0,43
906 613 43700		34 / 37	0,59

SIN FIN – made in Spain

	MEDIDA	SIN FIN W1		UDS. LOTE	€ LOTE
		UDS. BLISTER	€ BLISTER		
113008753	08-16	6	4,50	50	28,80
113008761	12-22	6	6,50	50	30,00
113008770	16-27	4	4,90	50	31,20
113008788	20-32	4	5,20	50	33,60
113008796	25-40	2	3,00	50	36,00
113008809	30-45	2	3,00	50	39,60
113008817	32-50	2	3,30	50	42,00
113008825	40-60	2	3,60	25	24,00
113008833	50-70	-	-	25	30,00
113008841	60-80	-	-	25	32,40

AÑADIR A CÓDIGO: **BL-BLISTER LO-LOTE**



MANGUERAS DE ASPIRACIÓN

CÓDIGO	d mm interior	D mm exterior	Rollos Mts***	P.V.P €
960 025	25	32	60	5,10
960 030	30	38	60	7,90
960 040	40	49	30	10,80
960 050	50	59	30	15,40

- * Manguera PVC plastificado transparente con espiral de acero
- * Indicada para aspiración e impulsión de líquidos - * Flexible - Superficies lisas
- * Temperatura de uso -5°C +65°C.

***Sobre coste manipulación metraje inferior 5 €



PULVERIZADORES DE COLUMNA - MICROJET -

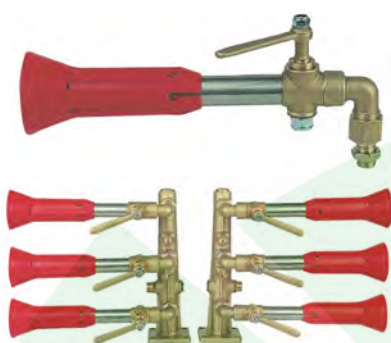

CÓDIGO	DESCRIPCIÓN	P.V.P. €
002 320C	PORTABOQUILLAS LATON P/ BARRA PULVERIZADORA C/JUNTA ARTICULADA, CAÑA EN INOXIDABLE. C/BOQUILLA CERÁMICA Ø 1,5	54,40
004 122	BARRA PULVERIZADORA DE COLUMNA CON JUNTA ARTICULADA (3 + 3) CAÑA EN INOX	414,00
004 123	BARRA PULVERIZADORA DE COLUMNA CON JUNTA ARTICULADA (4 + 4) CAÑA EN INOX	521,00



CÓDIGO	DESCRIPCIÓN	P.V.P. €
004 011	COLUMNA SUELTA (CON TAPONES Y UNIONES)	54,60

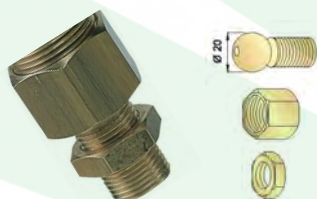

CÓDIGO	DESCRIPCIÓN	P.V.P. €
002 830	RÁCOR ESFERICO MICROJET 1/4" M Ø20	2,71
002 831	RÁCOR ESFERICO MICROJET 3/8" M Ø20	2,92
002 820	TUERCA M 24 x 1,5	2,16
002 810	CONTRATUERCA 3/8"	0,68

PORTABOQUILLAS DE MARIPOSA



CÓDIGO	DESCRIPCIÓN	CONEXIÓN	P.V.P. €
61.610.112	CABEZAL "TURBO" CON BOQUILLA CERAMICA 1,2 mm SIN ACOPLAMIENTO ESFERICO	M 1/2"	14,00



CÓDIGO	CONEXIÓN	P.V.P. €
002 620	RÁCOR ESFERICO MARIPOSA M 1/4" - Ø 16	4,54
002 630	TUERCA H 1/2	1,50
002 640	CONTRATUERCA 1/4"	0,57



CÓDIGO	DESCRIPCIÓN	CONEXIÓN	P.V.P. €
61.610.120	CABEZAL TURBO CON ANTIGOTA BOQUILLA CERAMICA 1,2 mm RACOR ESFERICO INCLUIDO	M 1/2"	22,10

MÓDULO ANTIGOTA P/ MICROJET C/RACOR M 1/4 Y JET MARIPOSA

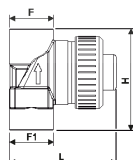

CÓDIGO	F-IN	F1-OUT	H mm	L mm	P.V.P. €
006 201	1/4 M	1/4 H	48	42	9,20
006 202	1/4 H	1/4 H	40	42	8,45
006 203	3/8 M	1/4 H	48	42	9,74



JETS LATÓN ANTIGOTA SIN BOQUILLAS



CÓDIGO	DESCRIPCIÓN	CONEXIÓN	P.V.P. €
75.617.6	JET LATON DOBLE "M75" ANTIGOTA (Sin boquillas)	M 1/4"	23,00
75.617.8		H 1/4"	
82.617.18	JET M82 BOBLE ANTIGOTA REGULABLE. PLACA 1,5 LADO REGULABLE. LADO STANDAR SIN BOQUILLAS	M 1/4"	30,40
058 42C 900	JET LATON DOBLE "058" ANTIGOTA (SIN BOQUILLAS) PREDISPUESTO P/ATR	M 1/4	17,93
058 44C 900		H 1/4	18,30
058 46C 900		M 3/8	18,40
75 617 88B	JET DOBLE COMPACTO CON ANTIGOTA Y ACOPLE ARCO 1/2" (Sin boquillas - P/ PLACAS EXT 15)		31,00

RECAMBIO/accesorios



CÓDIGO	DESCRIPCIÓN	P.V.P. €
5880.036	MEMBRANA ANTIGOTA SERIE 058	0,55
PLANA-266.100.64	MEMBRANA D. 22,5 -P/ M75 ANTIGÜA	1,80
300.100.63	MEMBRANA D.24 - M75/M82/M84	2,70
73.204.12	DIFUSOR EXT. 15 - CIEGO	0,50
73.204.14	DIFUSOR EXT. 15 - Ø 1,2	0,85
73.204.15	DIFUSOR EXT. 15 - Ø 1,5	
73.204.16	DIFUSOR EXT. 15 - Ø 1,8	
424 190	JUNTA NAYLON 3/8 "	0,13
73.602.22	O.R. 3043 - 3/8"	0,25
G10031	O.R. 13, 1 x 2,62 P/SERIE 058	0,19
75 605 46	TUERCA M24	1,30
256 605 7	TUERCA 3/8 NIQUELADA	1,10
18004 300x	PLACA EXT 15 mm Ø 0,8/1/1,2/1,5/1,8/2/2,3/3/4/6	0,63

2022



JETS ATOMIZADOR - NYLON/LATON

GIRATORIO Y CIERRE CON PLACA CERÁMICA Y DIFUSOR INOX
 (placa Ø 1,5mm + difusor Ø 1,2mm / placa Ø 1,2mm + difusor ciego)



CÓDIGO	DESCRIPCIÓN	CONEXIÓN	P.V.P. €
005 8820	JET DOBLE ANTIGOTA	M 1/4"	16,02
005 8720	JET DOBLE	M 1/4"	13,80
004 3820	JET SIMPLE ANTIGOTA	M 1/4"	13,52
004 3720	JET SIMPLE	M 1/4"	11,40
004 3420	JET SIMPLE LATON C/ ANTIGOTA	M 1/4"	18,20
004 3460		M 3/8"	20,09
005 892 C	CABEZAL REGULABLE ADAPTABLE A TODOS LOS JETS - PLACA 1,5 - Ext. 1,5		3,89

RECAMBIOS - PLACAS/DIFUSOR EXT. 18



CÓDIGO	DESCRIPCIÓN	P.V.P. €
18 5808	EXT. 18 - Ø 0,8	1,00
18 5810	EXT. 18 - Ø 1	
18 5812	EXT. 18 - Ø 1,2	
18 5815	EXT. 18 - Ø 1,5	
18 5818	EXT. 18 - Ø 1,8	
18 5820	EXT. 18 - Ø 2	0,85
HP 18300	FILTRO INOX- ext 18	
HP 18200	CIEGO	
HP 18210	Ø 1	
HP 18212	Ø 1,2	
HP 18215	Ø 1,5	0,52
HP 18100	JUNTA 13X20X3	
5.880.036	MEMBRANA ANTIGOTA	0,55



ACCESORIOS JETS



CÓDIGO	DESCRIPCIÓN	CONEXIÓN	P.V.P. €
103 311 000 00	BIJET DE ACOPLAMIENTO UNIVERSAL	H 3/8"	17,20
103 311 220 00		M-22	18,00

ACOPLAMIENTOS



CÓDIGO	DESCRIPCIÓN	P.V.P. €
103 311 438 00	ACOPLAMIENTO PARA TUBO Ø 1/2" (ROSCA H 1/4" - M3/8"). C/TORNILLOS Y OR	8,10
103 311 400 00	ACOPLAMIENTO PARA TUBO Ø 1/2" (ROSCA H 1/4" - Ø 16,6). C/TORNILLOS Y OR	6,50
103 311 038 00	ACOPLAMIENTO PARA TUBO Ø 1/2" (ROSCA H 3/8") CORTO. C/TORNILLOS Y OR	6,13



CÓDIGO	DESCRIPCIÓN	CONEXIÓN	P.V.P. €
267 612 177	ABRAZADERA LATÓN PARA TUBO 1/2" CON JUNTA Y TORNILLOS	H 1/4"	4,10
265 612 176		M 3/8" C/ TUERCA	5,00

ARCOS INOX PARA ATOMIZADOR -7 PORTABOQUILLAS-

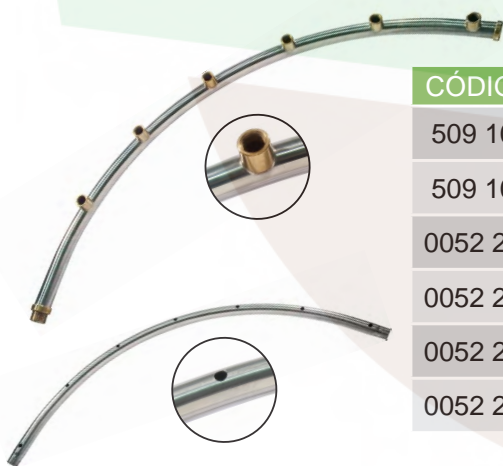

CÓDIGO	DESCRIPCIÓN	R curva mm	P.V.P. €
509 100	TOMAS ROSCA 1/2" M ACOPLES ROSCADOS INT 1/4 "H	417	86,80
509 101		455	
0052 202	TOMAS ROSCA 1/2 " M P/ ACOPLES DESMONTABLES Ø TALADRO 7 mm	395	32,90
0052 203		445	35,28
0052 204		495	36,36
0052 205		545	38,63

UNIONES ESPECIALES 1/4 M - 3/8" M



VER PÁGINA 102 - RACORERÍA



PORTABOQUILLAS HERBICIDAS (SIN ANTIGOTA) 20 bar

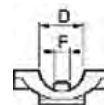

CÓDIGO	DESCRIPCIÓN	D Ø	F mm	P.V.P. €
400 730	PORTABOQUILLAS CON ABRAZADERA ARTICULADA Y ACOPLAMIENTO RAPIDO (SIN CABEZAL)	1/2"	7	1,63
400 520	PORTABOQUILLAS CON ABRAZADERA ARTICULADA Y CABEZAL ROSCADO 3/8"	20 mm	7	1,63
400 530		1/2"	7	1,63
400 550		3/4"	10	1,70

PORTABOQUILLAS HERBICIDA MONTAJE LATERAL CON ANTIGOTA



CÓDIGO	DESCRIPCIÓN	D Ø	P.V.P. €
4063 745	PORTABOQUILLAS ACOPLÉ RÁPIDO MONTAJE LATERAL C/ANTIGOTA. PRES. MÁX 20 bar	1/2"	3,36

ANTIGOTA CIERRE POR AIRE

VÁLVULA DE CIERRE NEUMÁTICA "FLOW STOP"

NORMALMENTE CERRADA - CONSUMO 0,0069 LT/CICLO-PRESIÓN AIRE MÍNIMA 3,8 BAR
PRESIÓN MÁXIMA LÍQUIDO - 8 BAR.

JUNTAS Y MEMBRANA VITON - ADAPTABLE A TODOS LOS PORTABOQUILLAS CON ANTIGOTA



CÓDIGO	DESCRIPCIÓN	P.V.P. €
424 510	CONEXION AIRE H 1/8	19,10
424 520	CONEXIÓN ORIENTABLE H 1/8	19,52
424510.060V	MEMBRANA VITON RECAMBIO	0,94

EJEMPLOS DE APLICACIÓN





**PORTABOQUILLAS HERBICIDAS
(CON ANTIGOTA) 20 bar**



CÓDIGO	DESCRIPCIÓN	D Ø	F mm	P.V.P. €
402 235	PORTABOQUILLAS CON ABRAZADERA CON ANTIGOTA DE MEMBRANA Y ACOPLAMIENTO RAPIDO (SIN CABEZAL) - HASTA FIN DE EXISTENCIAS -	1/2"	7	2,98
402 025	PORTABOQUILLAS CON ABRAZADERA CON ANTIGOTA DE MEMBRANA Y CABEZAL ROSCADO 3/8" - HASTA FIN DE EXISTENCIAS -	20 mm	7	3,10
402 035		1/2"	7	3,10
402 725	PORTABOQUILLAS CON ABRAZADERA ANTIGOTA ACOPLA RAPIDO - SIN CABEZAL-	20 mm	7	3,19
402 75A5		25 mm	10	3,79
402 735		1/2"	7	3,19
402 745		1/2"	10	3,19
402 755		3/4"	10	3,79
402 525	PORTABOQUILLAS CON ABRAZADERA ARTICULADA Y ANTIGOTA DE MEMBRANA Y CABEZAL ROSCADO 3/8"	20 mm	7	3,19
402 535		1/2"	7	3,19

OTRAS MEDIDAS DE ACOPLA A TUBO DISPONIBLES BAJO DEMANDA

ACCESORIOS. RECAMBIO

CÓDIGO	DESCRIPCIÓN	P.V.P. €
5860036	MEMBRANA EPDM	0,55
5865036	MEMBRANA VITON	1,19
400020030	OR P/ Ø 7 mm	0,13
G11057	OR P/ Ø 10 mm	0,13
400 100	KIT TORNILLOS ZN P/JETS ABRAZADERA	0,45
020 250	TORNILLO INOX P/ JET BISAGRA	0,33





PORTABOQUILLAS ORIENTABLE C/ANTIGOTA 20 bar

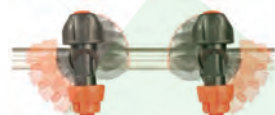

CÓDIGO	DESCRIPCIÓN	D Ø		P.V.P. €
4063 845	PORTABOQUILLAS ORIENTABLE ACOPLE RÁPIDO C/ANTIGOTA. PRES. MÁX. 20 bar - SIN ABRAZADERA -	1/2"	10	3,68
4063 855		3/4"	10	3,68
4063 865		1"	10	3,68
4063 845 C	PORTABOQUILLAS ORIENTABLE ACOPLE RÁPIDO CON ANTIGOTA Y CIERRE - SIN ABRAZADERA -	1/2"	10	6,60
400 030.020	ABRAZADERA SIMPLE	1/2"		0,62
400 050.020		3/4"		0,80
400 060 020		1"		0,80
400 100	KIT TORNILLO Y TUERCA - Zn			0,45
G11057	OR P/ ABRAZADERA			0,13
424 550	ANTIGOTA CON GRIFO DE CIERRE APLICABLE A TODA LA GAMA DE PORTABOQUILLAS ARAG, DOTADOS DE ANTIGOTEJO CLÁSICO	H 3/4"		2,92
4065 445C	PORTABOQUILLAS ORIENTABLE FINAL DE BARRA CON ANTIGOTA Y CIERRE	1/2" H		13,09
4065 845 C		EASYFIT		14,43

MEMBRANA DE RECAMBIO

CÓDIGO	DESCRIPCIÓN	P.V.P. €
005860.036	EPDM	0,55
005865.036	VITON	1,19



**PORTABOQUILLAS HERBICIDAS MULTIPLES
(CON ANTIGOTA) TRIGET - 12 bar**



CÓDIGO	DESCRIPCIÓN	D Ø		P.V.P. €
4012 235	PORTABOQUILLAS DE 3 VIAS CON ANTIGOTA DE MEMBRANA Y ACOPLAMIENTO RAPIDO (SIN CABEZAL)	1/2"	7	11,71
4012 245	<i>Disponible hasta fin existencias</i>		10	11,71
4012 035	PORTABOQUILLAS DE 3 VIAS CON ANTIGOTA DE MEMBRANA Y CABEZAL ROSCADO 3/8"	1/2"	7	10,38
4012 045	<i>Disponible hasta fin existencias</i>		10	10,38
4012 737	PORTABOQUILLAS DE 3 VIAS CON ANTIGOTA DE MEMBRANA Y ACOPLAMIENTO RAPIDO - SIN CABEZAL- ABRAZADERA BISAGRA	1/2"	7	12,26
4012 747			10	12,26

COMPACT JET - 20 BAR



CÓDIGO	DESCRIPCIÓN	D Ø		P.V.P. €
4064 227	3 VIAS CON ANTIGOTA Y ABRAZADERA BISAGRA. Tornillo y tuerca inox incluidos. ACOPLAMIENTO RAPIDO - SIN CABEZAL	20 mm	7	9,34
4064 237		1/2"	7	
4064 247		1/2"	10	
4064 257		3/4"	10	
4064 727	4 VIAS CON ANTIGOTA Y ABRAZADERA BISAGRA. Tornillo y tuerca inox incluidos. ACOPLAMIENTO RAPIDO - SIN CABEZA	20 mm	7	9,34
4064 737		1/2"	7	
4064 927	5 VIAS CON ANTIGOTA Y ABRAZADERA BISAGRA. Tornillo y tuerca inox incluidos. ACOPLAMIENTO RAPIDO - SIN CABEZAL	20 mm	7	9,34
4064 937		1/2"	7	
4064 947		1/2"	10	
4064 957		3/4"	10	

ACCESORIOS. RECAMBIO



CÓDIGO	DESCRIPCIÓN	P.V.P. €
5860036	MEMBRANA EPDM	0,55
5865036	MEMBRANA VITON	1,19
400020030	OR P/ Ø 7 mm	0,13
G11057	OR P/ Ø 10 mm	0,13
400 100	KIT TORNILLOS ZN P/JETS ABRAZADERA	0,45
020 250	TORNILLO INOX P/ JET BISAGRA	0,33



PORTABOQUILLAS HERBICIDAS ROSCADO (CON ANTIGOTA) 20 bar



CÓDIGO	DESCRIPCIÓN	D Ø	P.V.P. €
402 275	PORTABOQUILLAS ROSCADO CON ANTIGOTA DE MEMBRANA Y ACOPLAMIENTO RAPIDO (SIN CABEZAL)	M 1/4"	3,07
402 285		H 3/8"	3,41
402 075	PORTABOQUILLAS ROSCADO CON ANTIGOTA DE MEMBRANA Y CABEZAL ROSCADO 3/8"	M 1/4"	3,14
402 085		H 3/8"	3,46

PORTABOQUILLAS



CÓDIGO	DESCRIPCIÓN	D Ø	P.V.P. €
402 275C	PORTABOQUILLA, ROSCADO, CON ANTIGOTA DE MEMBRANA Y GRIFO DE CIERRE. ACOPLÉ RÁPIDO (SIN CABEZAL). Disponibile con membrana de Viton, bajo demanda.	M 1/4"	5,46
402 285C		H 3/8"	6,26
402 075C	PORTABOQUILLA, ROSCADO, CON ANTIGOTA DE MEMBRANA Y GRIFO DE CIERRE. CABEZAL ROSCADO G 3/8". Disponibile con membrana de Viton, bajo demanda.	M 1/4"	6,06
402 085C		H 3/8"	6,35
424 550	ANTIGOTA CON GRIFO DE CIERRE APLICABLE A TODA LA GAMA DE PORTABOQUILLAS ARAG, DOTADOS DE ANTIGOTEJO CLÁSICO	H 3/4"	2,92



CÓDIGO	DESCRIPCIÓN	P.V.P. €
269.616.2	PORTABOQUILLA LATON PRES MAX 30 bar IN 1/4 M - OUT BAYONETA	16,10
266.618.17	TUERCA BAYONETA INOX C/JUNTA PARA BOQUILLAS TIPO ...	ISO Ch8 6,80
266.618.18		PLACA EXT 15 9,60



PORTABOQUILLAS ARTICULADOS



CÓDIGO	DESCRIPCIÓN	Ø	P.V.P. €
404 070	PORTABOQUILLAS ARTICULADO CON CABEZAL ROSCADO 3/8"	H 1/4"	4,87
404 080		H 3/8"	4,87
404 082	PORTABOQUILLAS ARTICULADO CON ACOPLÉ RÁPIDO 3/8" - SIN CABEZAL	H 3/8"	4,87
404 072		H 1/4"	4,88
404 170	DOBLE PORTABOQUILLAS ARTICULADO C/CABEZAL ROSCADO 3/8"	H 1/4"	5,52
404 180		H 3/8"	5,41
404 182	PORTABOQUILLAS ARTICULADO DOBLE CON ACOPLÉ RÁPIDO - SIN CABEZALES	H 3/8"	5,52

PORTABOQUILLAS ARTICULADOS REFORZADOS



CÓDIGO	DESCRIPCIÓN	Ø	P.V.P. €
264 612 172	PORTABOQUILLAS ARTICULADO SIMPLE, CON CABEZAL ROSCADO	M 1/4"	6,10
264 612 173		H 1/4"	6,60
264 612 171	PORTABOQUILLAS ARTICULADO DOBLE, CON CABEZAL ROSCADO	M 1/4"	7,55
264 612 167		H 1/4"	7,40

2022



ADAPTACIONES BAYONETA STANDAR



CÓDIGO	DESCRIPCIÓN	Ø / mm	P.V.P. €
4029 1601	CONEXIÓN 45° PARA DOBLE ACOPLAMIENTO RÁPIDO.		2,25
4029 1401	ACOPLE RÁPIDO PARA BOQUILLA 90°.		1,60
400 279	RÁCOR FINAL 1/2" HEMBRA CON ACOPLE RÁPIDO 45°.	1/2"	1,41
400 280	RÁCOR FINAL 3/4" HEMBRA CON ACOPLE RÁPIDO 45°.	3/4"	1,51
400 270	ADAPTADOR ACOPLE RÁPIDO	M 1/4"	0,80
400 275N		H 1/4"	1,19
400 276		H 3/8"	1,70
105 110	LATIGUILLO PLANO PARA TUERCA	Ø10	0,47
105 108		Ø8	
402 904 03	TUERCA A/R PARA LATIGUILLO PLANO		0,56
400 276	MANGUITO ROSCA HEMBRA	H 3/8"	1,70
400 277		H 1/2"	1,70
400 278		H 3/4"	1,91
402 909 01	TUERCA CIEGA		0,56
92.163.560	ADAPTADOR PORTABOQUILLAS TIPO HARDI A BAYONETA ESTÁNDAR (LARGO 17 MM)		5,90
402.200.040	JUNTA DE RECAMBIO		0,22



ACCESORIOS

FILTROS

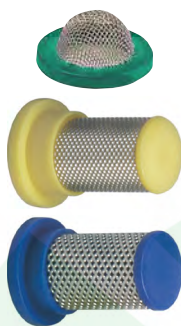

CÓDIGO	DESCRIPCIÓN		P.V.P. €
424 303	FILTRO INOX – ST- 50 Mesh	100	0,59
424 3313	FILTRO CILÍNDRICO 50 Mesh	50	0,77
424 3314	FILTRO CILÍNDRICO 100 Mesh	50	0,94
424 2313	FILTRO ANTIGOTA 50 Mesh	25	0,96
424 2314	FILTRO ANTIGOTA 100 MESH	25	1,05
424 23135	FILTRO ANTIGOTA 80 MESH	50	1,00

Disponible 424 2323-424 2324-Antigota 2 bar

TUBOS INOX AISI 304 MECANIZADOS

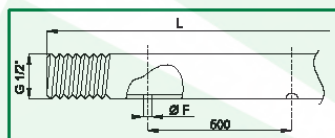

CÓDIGO	N.º AGUJEROS	L (cm)	P.V.P. €
F Ø 7 (mm)			
004 204	2	57	17,10
004 205	3	107	23,92
004 206	4	157	34,08
004 207	5	207	40,91
004 212	6	258	52,27
004 214	7	307	64,72

MORDAZAS Y ABRAZADERAS SOPORTE TUBOS

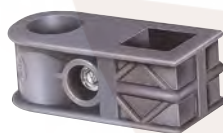

CÓDIGO	Ø	mm		P.V.P. €
GALVANIZADA CON TORNILLO				
004 208	1/2"	25	5	3,81
004 209	1/2"	30		3,81
PLÁSTICA **				
425 021	1/2"	20	10	1,41
425 022	1/2"	25		
425 031	20 mm	20		
425 032	20 mm	25		
BRIDA PLANA **				
425 120	20 mm		25	0,65
425 130	1/2" - 21 mm			0,65
425 150	3/4" - 26,4 mm			0,98
** 400 100 KIT TORNILLOS - OPCIONAL -				0,45
400 840	RÁCOR C/ABRAZADERA AGUJERO Ø 10 SALIDA ROSCA 1/2" HEMBRA	P/TUBO 1/2"		2,37
400 850		P/TUBO 3/4"		
020 250	TORNILLO INOX			0,33
CONEXIÓN ALIMENTACIÓN TUBO 1/2"				
400 64B	AGUJERO Ø 14 SALIDA ROSCA M 1/2		10	3,57

2022



PORTABOQUILLAS PARA MANGUERA (máx. 20 bar)



CÓDIGO	Ø mm	P.V.P. €
413 3212	13	12,39

CÓDIGO	Ø mm	P.V.P. €
413 3222	13	12,39

CÓDIGO	Ø mm	P.V.P. €
413 3232	13	12,39

BRIDAS DE MONTAJE



CÓDIGO	P/TUBO Ø mm	P.V.P. €
413 003	26,4 - 3/4"	1,81
413 004	33,3 - 1"	1,81
413 005	42 - 1" 1/4	1,81

CÓDIGO	P/TUBO Ø mm	P.V.P. €
413 013	19 - 3/4"	1,81
413 014	25 - 1"	1,81
413 015	31,8 - 1" 1/4	1,83
413 016	38 - 1" 1/2	2,06

PORTAGOMA PARA ADAPTACION JETS A TUBO FLEXIBLE



Ø F

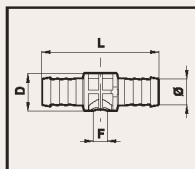

Ø F

SIMPLE CÓDIGO	D	Ø MANGUERA	F mm Ø	DOBLE CÓDIGO	P.V.P. €
426 210	1/2"	10	7	427 210	0,89
426 413	1/2"	13	10	427 413	0,70
428 210	ROSCA 1/2"	10	7		0,89



PORTABOQUILLAS PARA MANGUERA (máx. 20 bar)



CÓDIGO	Ø mm	P.V.P. €
413 211	10	4,12
413 212	13	4,12

CÓDIGO	Ø mm	P.V.P. €
413 221	10	4,12
413 222	13	4,12

CÓDIGO	Ø mm	P.V.P. €
413 231	10	4,12
413 232	13	4,22



CÓDIGO	Ø mm	P.V.P. €
413 511	10	1,73
413 512	13	1,73

CÓDIGO	Ø mm	P.V.P. €
413 521	10	1,73
413 522	13	1,73

CÓDIGO	Ø mm	P.V.P. €
413 531	10	1,73
413 532	13	1,73



CÓDIGO	Ø mm	P.V.P. €
413 411	10	3,61
413 412	13	3,61

CÓDIGO	Ø mm	P.V.P. €
413 421	10	3,61
413 422	13	3,61

2022



TUERCA BAYONETA UNIVERSAL



PATENTADA



UNA SOLA
TUERCA
PARA SUS
BOQUILLAS!!

COMPLETAR COLOR "xx"

COLOR	COD xx
ROJO	03
AZUL	04
VERDE	05
AMARILLO	06
MARRON	07

PARA BOQUILLAS TIPO

ASJ® AFC / BX / CFA / CFA-U / CFA-T / ATC / EF / FF / SF / LD / LDC / PSP / SFA / TFA / TFLD / TFS / WR / WRC / AOC

ALBUZ® API / ADI / AXI / APE-EXA / AVI / APM-EXA / CVI LECHLER LU

LURMARK FLAT FAN TIPS - AIR MIX

TEEJET® FLAT FAN TIPS

STD.-0067 -08

XR -01 -06

DG -015 -05





LECHLER SERIE 652

LECHLER SERIE ID - IDK

AI TEEJET®

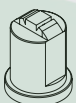
TUERCA BAYONETA PARA PORTABOQUILLAS TIPO HARDI



CÓDIGO	PARA USO CON BOQUILLAS (SOLO INDICATIVO)	P.V.P. €
18018 CPH FF01	 ASJ® SF / SFA / WR / WRC / LD / LDC / EF / TLT / AFC / CFA / CFA-U / CFA-T / AOC / OC ALBUZ® API / ADI / AXI80 / AXI110 / OCI / CVI110 LECHLER® IDK / IDKN / IDKT / LU / AD / AD90 / ST / IDKS / ES / OC (SMALL SIZE) HYPRO® POM110 / DRIFT BETA 120° / POM 80° / GUARDIAN AIR / LODRIFT 110 / ULD120 / DEFLECTIP / AIRMIX 110 TEEJET® STANDARD 0067_08 / XR01_08 / DG / TTJ / AIXR / TT / OC	1,10
18018 CPH TF01	 ASJ® TFS / TFLD / PSP / BX ALBUZ® APE / EXA / ESI / AVI110 / AVIOC / APM / MVI AVI80  ASJ® ATF / TFA ALBUZ® AVI-TWIN	1,10
18018 CPH HC01	 ASJ® HC / HCF  ASJ® DEF / DEF140 ALBUZ® TK / FLOODJET®  FL FULLJET®  TG FULLCONE  TX / AITXA CONEJET® LECHLER TR / ITR	1,10
402 200.040	JUNTA DE RECAMBIO	0,22

TUERCA BAYONETA PROLONGADA REFORZADA











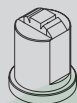

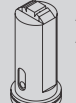







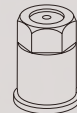





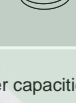





CÓDIGO	PARA USO CON BOQUILLAS (SOLO INDICATIVO)	P.V.P. €
18025 921645650	 ASJ® SF / SFA / WR / LD / LDC / EF / TLT / AFC / CFA / CFA-U / CFA-T / AOC / OC ALBUZ® API / ADI / AXI / AXI80 / AXI110 / OCI / OC LECHLER® IDK / IDKN / IDKT / LU / AD / AD90 / ST / IDKS / ES / OC HYPRO® POM110 / DRIFT BETA 120° / POM 80° / GUARDIAN AIR / LODRIFT 110 / ULD120 / DEFLECTIP / AIRMIX 110 TEEJET® STANDARD 0067_08 / XR01_08 / DG / TTJ / AIXR / TT / OC	3,40
402 200.040	JUNTA DE RECAMBIO	0,22

BOQUILLA NO INCLUIDA



TUERCAS BAYONETA ESPECÍFICAS - INCLUYEN JUNTAS -

	CÓDIGO	PARA USO CON BOQUILLAS (SOLO INDICATIVO)	P.V.P. €
	402 901 03 C/JUNTA 402200040	 ASJ® TFS / TFLD / PSP / BX  ALBUZ® APE / EXA / ESI / AVI110 / AVIOC / APM / MVI AVI80  ASJ® ATF / TFA  ALBUZ® AVI-TWIN	0,56
	402 904 03 C/JUNTA 402200040	 ASJ® HC / HCF  ASJ® DEF / DEF140  ALBUZ® TK / FLOODJET®  FL FULLJET®  TG FULLCONE  TX / AITXA  CONEJET®  LECHLER TR / ITR	0,56
	402 905 03 402200040+ 402105030	 ASJ® HCA80 / HCC / HCI80 / HCI 60 / HCI 40  ALBUZ® ATR 80 / ATR 60 / ATI 60 / TVI80  ASJ® NC DC  ALBUZ® ATR / AMPT  Placa y difusor de cerámica	0,56
	402 906 03 C/ JUNTA 402 200 040	 TeeJet® Flat Spray Tips (larger capacities) Standard -10 -20 XR -10 -20	0,56
	402 907 03 C/ JUNTA 402 200 040	 TJ TwinJet® N°. TJ60 Spary Tip TeeJet® TTI/SJ3/DG TJ60  TeeJet® AI/AIUB N°. AI Spary Tip	0,56
	402 908 03 C/ JUNTA 402 200 040	 ASJ® DEF/DEF 140 TK-VS FloodJet®  Turbo FloodJet®	0,56
	402 915 03 402200040+ G11015	 ALBUZ® TVI	0,56
	402 909 01 C/JUNTA 402200040	TUERCA CIEGA (TAPON)	0,56
	402 912 01 402 910 01 C/JUNTA 402200040	C/ROSCA HEMBRA 1/8 " - NPT C/ROSCA HEMBRA 1/4 " - NPT PARA USO DE BOQUILLAS ROSCADAS O MANOMETRO DE CONTROL	1,12

2022

JUNTAS P/RECAMBIO	
CÓDIGO	P.V.P. €
402 200 040	0,22
402 105 030	0,13
G11015	0,13

STANDAR
COMPLETAR COLOR "xx"

COLOR	COD xx
ROJO	03
AZUL	04
VERDE	05
AMARILLO	06
MARRON	07

MÍNIMO 2000 UNIDADES

NEGRO	01
BLANCO	02
GRIS	10



BOQUILLAS DE PULVERIZACION **LECHLER**

Calidad acreditada bajo los requisitos BBA (Instituto Biológico Alemán) y CEN (Organización Europea de Normalización)

“IDTA” - CAP TWIN ASIMETRICO INYECCION DE AIRE – “IDTA”



ESPECTRO DE DOBLE COBERTURA EXCEPCIONALMENTE UNIFORME

DOBLE ABANICO DEFLECTADO EN DISTINTOS ANGULOS:

- DELANTE – 30° - DETRÁS - 50°

DOBLE ANGULO DE ASPERSION:

* - 120° DELANTE (60 % VOLUMEN PULVERIZADO)

* - 90° DETRÁS (40 % VOLUMEN PULVERIZADO)

*MATERIAL CERAMICA - *EXTRAORDINARIA BAJA DERIVA

- *RANGO DE TRABAJO 1 – 4 – 8 bar

*ALTA PRECISIÓN EN DELIMITACION DE BORDES COMBINADA CON “IS 80”

*OPTIMA PROTECCION AL USUARIO EN LA MANIPULACION DEL INYECTOR QUE PUEDE SER EFECTUADA CON GUANTES Y SIN HERRAMIENTAS



PATENTADA

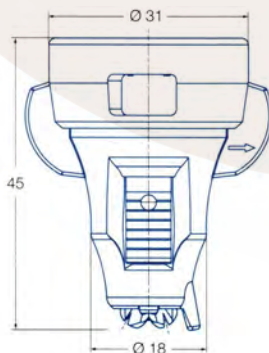
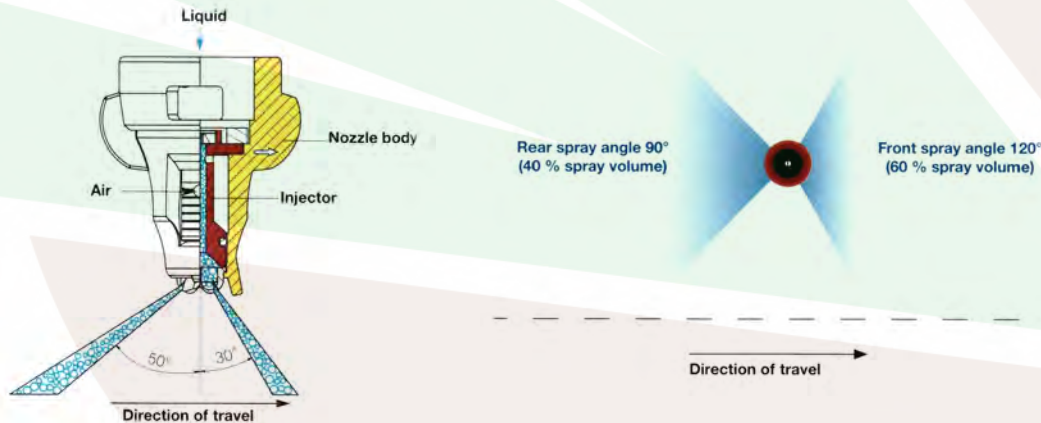

CÓDIGO		P.V.P. €
180257200 + CC COLOR + 210	UNIDAD	23,90
180257300 + CC COLOR + 210	PACK 10 UNIDADES	215,00

ISO	02	25	03	04	05	06	08
-----	----	----	----	----	----	----	----













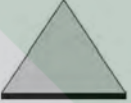

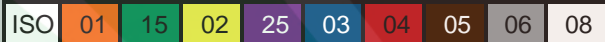

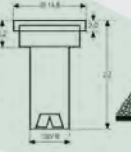

2022

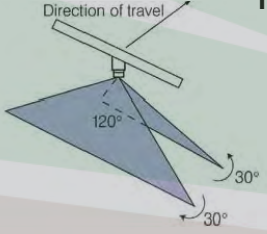

BOQUILLAS DE PULVERIZACIÓN 

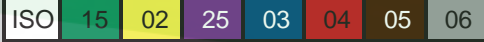
Calidad acreditada bajo los requisitos BBA (Instituto Biológico Alemán)
y CEN (Organización Europea de Normalización)

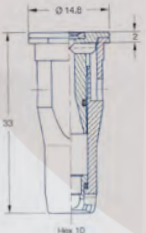
CONSULTE PRECIOS SEGÚN CANTIDADES

	CÓDIGO	P.V.P. €
 	TIPO 'ST' 110° ABANICO PLANO MATERIAL PLÁSTICO POM 180250100 + COLOR ISO + 110  	0,68
	MATERIAL CERÁMICO 180250110 + COLOR ISO + 110 	4,45
	TIPO ST 80° POM 180250100 + COLOR ISO + 80 	1,20
 	 TIPO 'IDK' 120° ANTIDERIVA COMPACTA MATERIAL PLÁSTICO POM 180258000 + COLOR ISO + 120	4,45
	TIPO 'IDK-C' 120° ANTIDERIVA COMPACTA MATERIAL CERÁMICO 180258500 + COLOR ISO + 120   	10,20
	TIPO 'IDKT' DOBLE ABANICO 120° MATERIAL CERÁMICA 180256500 + COLOR ISO + 120   	19,30
 	TIPO 'ID3' / 'ID' 120° ANTIDERIVA ABANICO PLANO CON INYECCION DE AIRE EXCELENTE CONTROL DE LA DERIVA RANGO DE TRABAJO 2-4-8 bar MATERIAL PLÁSTICO POM ID3 - 180257100 + COLOR ISO + 120 	8,65
	MATERIAL CERÁMICO ID - 180257010 + COLOR ISO + 120 9,70 DISPONIBLE HASTA FIN DE EXISTENCIAS	
	ID3 - 180257110 + COLOR ISO + 120  	12,11

2022



BOQUILLAS DE PULVERIZACION **LECHLER**

Calidad acreditada bajo los requisitos BBA (Instituto Biológico Alemán) y CEN (Organización Europea de Normalización)

CONSULTE PRECIOS SEGÚN CANTIDADES

CÓDIGO		P.V.P. €
<p>TIPO "OC" ASIMÉTRICA FINAL DE BARRA PULVERIZADO LATERAL Y/O DELIMITACION AREA TRATADA, SEGÚN POSICION DE MONTAJE</p> <p>MATERIAL LATON</p> <p>OC 02 /03/04/05/06/08 – 80° COD. 180240800 + TIPO + 080</p> <p>OC 05 /08/12 – 90° COD.180250820 + TIPO + 090</p>		<p>9,10</p> <p>9,60</p>
<p>TIPO "OFF CENTER BN 100" APLICACIONES SIN BARRA Y/O BANDAS</p> <p>MATERIAL PLÁSTICO POM</p> <p>CAUDAL L/MM A 3 BAR - 2,76</p> <p>BLANCA - BN 07 L - IZQUIERDA NEGRA BN 07 R - DERECHA COD.18025900013N07</p>		<p>6,10</p> <p>6,10</p>
<p>TIPO "FT" ESPEJO 140° MATERIAL PLÁSTICO POM</p> <p>COD. 180250300 + COLOR + 140</p>		<p>3,14</p>

BAR	CAUDAL L / MIN		
	2	3	4
OC2	0,65	0,80	0,92
OC3	0,98	1,20	1,39
OC4	1,31	1,60	1,85
OC5	1,58	1,94	2,24
OC6	1,96	2,40	2,77
OC8	2,61	3,20	3,70
OC12	4,00	4,90	5,66
OC20	6,30	7,71	8,91

BAR	L / MIN - FT -			
	1	1,5	2	3
0.5 FT NARANJA	0,23	0,28	0,32	0,39
0.75 FT VERDE	0,35	0,43	0,50	0,61
1.0 FT AMARILLA	0,45	0,55	0,63	0,77
1.5 FT AZUL	0,71	0,87	1,00	1,22
2.0 FT ROJA	0,88	1,08	1,25	1,53
2.5 FT MARRON	1,13	1,39	1,60	1,96
3.0 FT GRIS	1,41	1,73	2,00	2,45
4.0 FT BLANCA	1,77	2,17	2,50	3,06

2022



NEW



BOQUILLAS DE PULVERIZACIÓN 

Calidad acreditada bajo los requisitos BBA (Instituto Biológico Alemán)
y CEN (Organización Europea de Normalización)

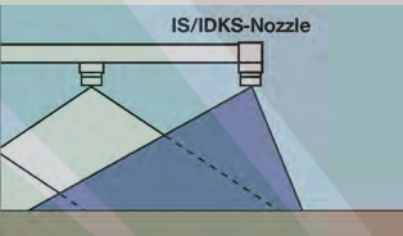
CONSULTE PRECIOS SEGÚN CANTIDADES

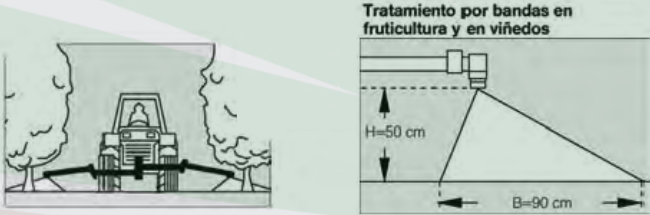
CÓDIGO	P.V.P. €
<p>TIPO "IDKS" FINAL BARRA 80° MATERIAL PLÁSTICO POM COD.180255500 + COLOR + 080</p>  	10,75
<p>TIPO "IS" ANTIDERIVA 80° ASIMÉTRICA INYECCION DE AIRE MATERIAL PLÁSTICO POM COD.180257500 + COLOR + 080</p>   	13,30

2022

BAR	L / MIN - IDKS - IS -													
	1	1,5	2	3	4	5	6	7	8					
015 VERDE		0,28	0,32	0,39	0,45	0,51	0,55							
02 AMARILLA		0,42	0,48	0,49	0,59	0,60	0,68	0,69	0,76	0,77	0,83	0,84	0,91	0,97
025 LILA		0,56	0,65	0,70	0,80	0,86	0,92	0,90	1,03	1,13	1,13	1,24	1,34	1,43
03 AZUL	0,57	0,70	0,81	0,86	0,99	1,05	1,15	1,21	1,28	1,35	1,40	1,48	1,60	1,71
04 ROJA	0,69	0,84	0,97	1,11	1,19	1,36	1,37	1,57	1,53	1,75	1,68	1,92	2,07	2,21
05 MARRON	0,91	1,12	1,29	1,23	1,58	1,51	1,82	1,74	2,04	1,95	2,23	2,14	2,31	2,47
06 GRIS	1,14	1,39	1,61	1,36	1,97	1,67	2,28	1,93	2,56	2,16	2,79	2,37	2,56	2,73



BOQUILLAS DE PULVERIZACIÓN

Calidad acreditada bajo los requisitos BBA (Instituto Biológico Alemán) y CEN (Organización Europea de Normalización)

CONSULTE PRECIOS SEGÚN CANTIDADES

CÓDIGO		P.V.P. €
  	<p>TIPO 'TR' 80° CHORRO CÓNICO HUECO GAMA DE PRESIÓN DE 2,5 - 15 BAR GRAN MICRONIZACIÓN, COBERTURA Y EXCELENTE PENETRACIÓN EN CULTIVOS <i>MATERIAL CERÁMICO</i> COD. 18025 5010 + COLOR + 080</p> <p>ISO 005 0067 01 015 02 025 03 04 05</p>	5,00
  	<p>TIPO 'ITR' 80° ANTIDERIVA CHORRO CÓNICO HUECO GAMA DE PRESIÓN DE 5 - 30 BAR DERIVA EXTRAORDINARIAMENTE BAJA <i>MATERIAL CERÁMICO</i> COD. 18025 6010 + COLOR + 080</p> <p>ISO 01 015 02</p>	15,20
 	<p>ANTIDERIVA INYECCIÓN DE AIRE PARA ARBOLADO, VIÑA Y HORTICULTURA ABANICO PLANO, ÍNDICE IDÓNEAMENTE EN EL FLUJO DE AIRE. EXTRAORDINARIA RESISTENCIA A LA DERIVA. COMPACTA Y ROBUSTA. CERÁMICA ALTAMENTE RESISTENTE AL DESGASTE <i>TIPO IDK 90°</i> COD. 18025620 + COLOR ISO + 090</p> <p>ISO 0067 01 015 02 025 03</p>	11,90
  	<p>TIPO "ID" 90° COD. 180257010 + COLOR + 090</p> <p>ISO 01 015 02 025 03 04 05 06</p>	13,00

NEW

2022

BOQUILLAS DE PULVERIZACIÓN ASJ SPRAY-JET

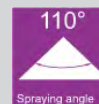
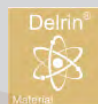
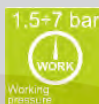
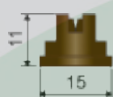
ESTÁNDAR 180180501100 + COLOR SF

0,55

ISO 01 015 02 025 03 04 05 06 08 10 15

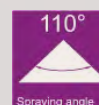
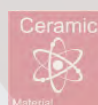
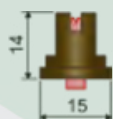
ESTÁNDAR BAJA DERIVA 180180451100 + COLOR LDC

3,70

ISO 015 02 025 03 04 05 06

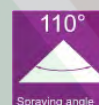
COMPACT FAN AIR 180180401100 + COLOR CFA

2,70

ISO 01 015 02 025 03 04 05 06 08

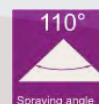
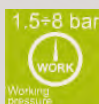
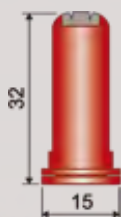
TWIN DOBLE ABANICO 18018069110 + COLOR TFA

3,85

ISO 02 03 04 05

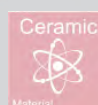
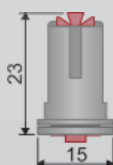
TWIN DOBLE ABANICO 180180301100 + COLOR ATC CERAMICA

10,30



ISO 015 02 025 03 04 05 06



BOQUILLAS DE PULVERIZACIÓN **ASJ SPRAY-JET**

CÓDIGO **P.V.P. €**

ESPEJO 140 180180141400 + COLOR DEF 140

COD.	bar	drop	l/min	lh. SEPARACION BOQUILLAS 100 cm					
				6 km/h	8 km/h	10 km/h	12 km/h	14 km/h	16 km/h
DEF140015	1	F	0.69	69	52	42	35	30	26
	2	F	0.98	98	73	59	49	42	37
	3	F	1.20	120	90	72	60	51	45
	4	F	1.39	139	104	83	69	59	52
DEF14002	1	F	0.92	92	69	55	46	40	35
	2	F	1.31	131	98	78	65	56	49
	3	F	1.60	160	120	96	80	69	60
	4	F	1.85	185	139	111	92	79	69
DEF140025	1	F	1.15	115	87	69	58	49	43
	2	F	1.63	163	122	98	82	70	61
	3	F	2.00	200	150	120	100	86	75
	4	F	2.31	231	173	139	115	99	87
DEF14003	1	F	1.39	139	104	83	69	59	52
	2	F	1.96	196	147	118	98	84	73
	3	F	2.40	240	180	144	120	103	90
	4	F	2.77	277	208	166	139	119	104
DEF14004	1	M	1.85	185	139	111	92	79	69
	2	M	2.61	261	196	157	131	112	98
	3	F	3.20	320	240	192	160	137	120
	4	F	3.70	370	277	222	185	158	139
DEF140075	1	M	3.46	346	260	208	173	148	130
	2	M	4.90	490	367	294	245	210	184
	3	M	6.00	600	450	360	300	257	225
	4	M	6.93	693	520	416	346	297	260
DEF14010	1	C	4.62	462	346	277	231	198	173
	2	C	6.53	653	490	392	327	280	245
	3	M	8.00	800	600	480	400	343	300
	4	M	9.24	924	693	554	462	396	346

1+6 bar
WORK
Working pressure

Delrin
Material



Band
Treatment

402908xx
Cap

140°
Spraying angle

GOTAS: F- FINA / M- MEDIA / C-GRUESA

AIR OFF CENTER
180180750800 + COLOR ISO AOC BAJA DERIVA

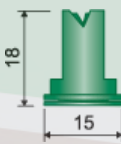
1.5+8 bar
WORK
Working pressure

Delrin
Material



402900xx
Cap

80°
Spraying angle

ISO 015 02 025 03 04 05

2,93

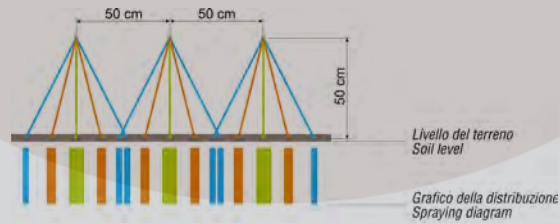
5 CHORROS ABONOS 180180720000 + COLOR PSP

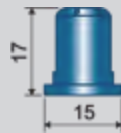
1+5 bar
WORK
Working pressure

Delrin
Material

402901xx
Cap

Fertilizers
Suitable for

ISO 015 02 03 04 05 06 08

3,52

2022



BOQUILLAS DE PULVERIZACIÓN ASJ SPRAY-JET



CAUDAL COLORES TIPO ALBUZ

CÓDIGO

CONO HUECO 80° 180180350800 + COLOR HCC

2+20 bar WORK Working pressure
Ceramic Material
402905xx Cap
80° Spraying angle

COD.	q (l / min)											
	9 bar	10 bar	11 bar	12 bar	13 bar	14 bar	15 bar	16 bar	17 bar	18 bar	19 bar	20 bar
HCC005	0.33	0.35	0.36	0.38	0.40	0.41	0.42	0.44	0.45	0.47	0.48	0.49
HCC0075	0.52	0.55	0.57	0.60	0.62	0.65	0.67	0.69	0.71	0.73	0.75	0.77
HCC01	0.69	0.73	0.77	0.80	0.83	0.86	0.89	0.92	0.95	0.98	1.01	1.03
HCC015	1.04	1.10	1.15	1.20	1.25	1.30	1.34	1.39	1.43	1.47	1.51	1.55
HCC02	1.39	1.46	1.53	1.60	1.67	1.73	1.79	1.85	1.90	1.96	2.01	2.07
HCC025	1.73	1.83	1.91	2.00	2.08	2.16	2.24	2.31	2.38	2.45	2.52	2.58
HCC03	2.08	2.19	2.30	2.40	2.50	2.59	2.68	2.77	2.86	2.94	3.02	3.10
HCC035	2.42	2.56	2.68	2.80	2.91	3.02	3.13	3.23	3.33	3.43	3.52	3.61
HCC04	2.77	2.92	3.06	3.20	3.33	3.46	3.58	3.70	3.81	3.92	4.03	4.13
HCC05	3.46	3.65	3.83	4.00	4.16	4.32	4.47	4.62	4.76	4.90	5.03	5.16

3,65



CONO HUECO 40° 180180360400 + COLOR HCI 40
CONO HUECO 60° 180180360600 + COLOR HCI 60

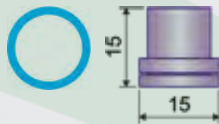

2+20 bar WORK Working pressure
Ceramic Material
ISO 10625 Colour coding
60° Spraying angle

COD.	q (l / min)											
	9 bar	10 bar	11 bar	12 bar	13 bar	14 bar	15 bar	16 bar	17 bar	18 bar	19 bar	20 bar
HCI60005	0.33	0.35	0.36	0.38	0.40	0.41	0.42	0.44	0.45	0.47	0.48	0.49
HCI600075	0.52	0.55	0.57	0.60	0.62	0.65	0.67	0.69	0.71	0.73	0.75	0.77
HCI6001	0.69	0.73	0.77	0.80	0.83	0.86	0.89	0.92	0.95	0.98	1.01	1.03
HCI60015	1.04	1.10	1.15	1.20	1.25	1.30	1.34	1.39	1.43	1.47	1.51	1.55
HCI6002	1.39	1.46	1.53	1.60	1.67	1.73	1.79	1.85	1.90	1.96	2.01	2.07
HCI60025	1.73	1.83	1.91	2.00	2.08	2.16	2.24	2.31	2.38	2.45	2.52	2.58
HCI6003	2.08	2.19	2.30	2.40	2.50	2.59	2.68	2.77	2.86	2.94	3.02	3.10
HCI60035	2.42	2.56	2.68	2.80	2.91	3.02	3.13	3.23	3.33	3.43	3.52	3.61
HCI6004	2.77	2.92	3.06	3.20	3.33	3.46	3.58	3.70	3.81	3.92	4.03	4.13
HCI6005	3.46	3.65	3.83	4.00	4.16	4.32	4.47	4.62	4.76	4.90	5.03	5.16

3,87



CONO HUECO 80° 180180380800 + COLOR ISO HCA 80

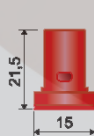

3+20 bar WORK Working pressure
Ceramic Material
ISO 10625 Colour coding
80° Spraying angle
402905xx Cap

ISO 01 015 02 025 03 04 05

11,00

$$\text{Vol (l/ha)} = \frac{\text{l/min} \times n \times 600}{\text{km/h} \times D \text{ (m)}}$$



n=n° boquillas

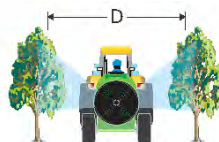









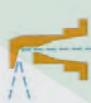

2022

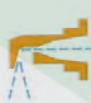

BOQUILLAS DE PULVERIZACIÓN



CÓDIGO	P.V.P. €																																	
<p>"FAN TIP" ABANICO ESTÁNDAR 80° Y 110° COD. 18024010 + COLOR ISO + GRADOS</p>   	0,88																																	
<p>"LP" ESPECIAL BAJA PRESION 80° Y 110° COD. 18024020 + COLOR ISO + GRADOS °</p>  	0,88																																	
<p>"DEFLEC TIP" - ESPEJO ÁNGULO 80° A 145° S/COLOR COD. 18024050 + COLOR ISO + GRADOS</p>  	1,10																																	
<p>"POLIJET" BAJA PRESION COD. 18024051 + COLOR + GRADOS</p>  <p><i>DISPONIBLES HASTA FIN DE EXISTENCIAS</i></p> <table border="1"> <thead> <tr> <th>TIPO</th> <th>BAR</th> <th>l/mn</th> <th>< °</th> <th>ANCHO h 50 cm</th> </tr> </thead> <tbody> <tr> <td rowspan="2">AN0.6 AMARILLA</td> <td>1</td> <td>0,6</td> <td rowspan="2">55°</td> <td rowspan="2">0,5 m</td> </tr> <tr> <td>2</td> <td>0,85</td> </tr> <tr> <td rowspan="2">AN1.2 VERDE</td> <td>1</td> <td>1,2</td> <td rowspan="2">90°</td> <td rowspan="2">1 m</td> </tr> <tr> <td>2</td> <td>1,7</td> </tr> <tr> <td rowspan="2">AN1.8 AZUL</td> <td>1</td> <td>1,8</td> <td rowspan="2">110°</td> <td rowspan="2">1,5 m</td> </tr> <tr> <td>2</td> <td>2,55</td> </tr> <tr> <td rowspan="2">AN2.4 ROJA</td> <td>1</td> <td>2,4</td> <td rowspan="2">130°</td> <td rowspan="2">2 m</td> </tr> <tr> <td>2</td> <td>3,39</td> </tr> </tbody> </table>	TIPO	BAR	l/mn	< °	ANCHO h 50 cm	AN0.6 AMARILLA	1	0,6	55°	0,5 m	2	0,85	AN1.2 VERDE	1	1,2	90°	1 m	2	1,7	AN1.8 AZUL	1	1,8	110°	1,5 m	2	2,55	AN2.4 ROJA	1	2,4	130°	2 m	2	3,39	0,70
TIPO	BAR	l/mn	< °	ANCHO h 50 cm																														
AN0.6 AMARILLA	1	0,6	55°	0,5 m																														
	2	0,85																																
AN1.2 VERDE	1	1,2	90°	1 m																														
	2	1,7																																
AN1.8 AZUL	1	1,8	110°	1,5 m																														
	2	2,55																																
AN2.4 ROJA	1	2,4	130°	2 m																														
	2	3,39																																
<p>"EVEN BAND TIP" 80° - TRATAMIENTO EN BANDAS - COD. 18024 030 + COLOR ISO + 080</p>   	0,88																																	

2022

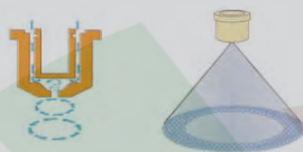

NARANJA	VERDE	AMARILLO	LILA	AZUL	ROJO	MARRON	GRIS	BLANCO	AZUL CL.	VERDE CL.	NEGRO	MALVA	PURPURA
01	015	02	025	03	04	05	06	08	10	15	20	30	40
L/min @ 3Bar	0.4	0.6	0.8	1.0	1.2	1.6	2.0	2.4	3.2	4.0	6.0	8.0	-

BOQUILLAS DE PULVERIZACIÓN
HYPRO®
LURMARK®

“HOLLOW TIP” CONO HUECO 80°
ALTA MICRONIZACIÓN
COD. 18024600 + COLOR + 080

1,35

COLOR	L / MIN				
	BAR				
	3	4	5	7	10
BLANCO	0,132	0,152	0,170	0,202	0,241
LILA	0,199	0,230	0,257	0,304	0,363
AZUL	0,265	0,306	0,342	0,405	0,484
NARANJA	0,397	0,458	0,513	0,606	0,725
GRIS	0,530	0,612	0,684	0,810	0,968
VERDE	0,596	0,688	0,769	0,910	1,088
NEGRO	0,662	0,764	0,855	1,011	1,209
AMARILLO	0,750	0,866	0,968	1,146	1,369
MARRON	1,180	1,363	1,523	1,802	2,154

“FULL CONE” - CONO LLENO - FCX 80°
COD 18024082 + COLOR + 080

1,60

COLOR	L / MIN				
	BAR				
	3	4	5	7	10
AMARILLO	1,280	1,480	1,650	1,960	2,340
AZUL	1,940	2,230	2,500	2,960	3,540
ROJO	2,580	2,980	3,330	3,940	4,710
MARRON	3,220	3,720	4,160	4,920	5,880
GRIS	3,860	4,450	4,980	5,890	7,050
BLANCO	5,160	5,950	6,660	7,880	9,420



BOQUILLAS DE PULVERIZACIÓN ALBUZ

CONSULTE PRECIOS SEGÚN CANTIDADES

	CÓDIGO	P.V.P. €
	 <p>"APE" 110° Y "APE" 80° - 18004000010 + COLOR - COLORES ALBUZ  TIPO "AXI" 80° - 18004000085 + COLOR TIPO "AXI" 110° - 18004000080 + COLOR CERAMICA ABANICO</p>	4,10
	 <p>"ADI" 110° ANTIDERIVA CERAMICA ABANICO - 18004000014 + COLOR </p>	5,20
	 <p>"OCI" CENTRO DESPLAZADO 15° - 65°  CERAMICA FINAL DE BARRA 180040060110 + COD COLOR ISO</p>	13,80
	 <p>"AVI" 110° ANTIDERIVA - 18004000013 + COLOR  TIPO "AVI" 80° ANTIDERIVA - 180040000145 + COLOR</p>	12,20
	 <p>"AVI" OC - CENTRO DESPLAZADO 15° - 65°  - INYECCION DE AIRE - 180040000138 + COLOR</p>	21,00
	 <p>"AVI-TWIN" - DOBLE CHORRO 110° ANTIDERIVA  CERAMICA INYECCION DE AIRE - 180040000139 + COLOR "CVI-TWIN" - BP 180040000137 + COLOR</p>	14,70 14,90
	 <p>MSI ESPEJO GRAN ANGULAR ISO -  18004000054 + COLOR</p>	7,00
	 <p>"MVI" ESPEJO INYECCION AIRE  CERAMICA - 180040000550 + COLOR</p>	16,00
	 <p>"EXA" TRES CHORROS COLORES ALBUZ - 180040000400 + COLOR</p>	5,15
	 <p>"ESI" SEIS CHORROS  CERAMICA ABONOS LIQUIDOS - 180040000410 + COLOR</p>	5,15

* FUERA FABRICACIÓN. DISPONIBLE HASTA FIN DE EXISTENCIAS

BOQUILLAS DE PULVERIZACIÓN ALBUZ

DISCOS
ALBUZ

CÓDIGO	P.V.P. €
 "ATR" 80° TURBULENCIA "CLIP" 180040000510 + COLOR ALBUZ	4,70
 "ATR" 60° TURBULENCIA 180040000490 + COLOR ALBUZ "ATI" 60° CAUDAL ISO 18004ATI60 + COLOR ISO "ATI" 80° CAUDAL ISO 18004ATI80 + COLOR ISO CHORRO CONICO HUECO	4,90
 "ATF" 80° CONO LLENO - COLORES ISO - AZUL - VERDE - AMARILLA - LILA - ROJA 18004ATF800 + COLOR	4,90
"TVI" 80° TURBULENCIA CHORRO CONICO CERAMICA INYECCION DE AIRE - 180040000520 + COLOR	14,00

CÓDIGO	P.V.P. €
 "AMT" 180040000300 + Ø EXT. 15 MM X H 3,5 MM DISCO CERAMICA Ø 0,8 - 1,0 - 1,2 - 1,5 - 1,8 - 2,0 - 2,3 - 3 - 4 - 6	0,63
 CONO LLENO DISCO + DIFUSOR COMBINADOS PLACA: 180040000035 + AD DIFUSOR: 180040000036 + AC	

DISCO	DIFUSOR	Ø	CAUDAL L / MIN							ÁNGULOS	
			3 bar	4 bar	5 bar	6 bar	10 bar	15 bar	20 bar	10 bar	20 bar
AD 1	AC 31	0,910					1,00	1,20	1,40	40°	38°
AD 2	AC 31	1,180					1,50	1,80	2,00	54°	49°
AD 3	AC 31	1,385					1,60	1,90	2,20	67°	58°
AD 1	AC 35	0,910					0,97	1,20	1,30	27°	27°
AD 2	AC 35	1,180					1,70	2,00	2,20	45°	40°
AD 3	AC 35	1,385					2,00	2,40	2,80	48°	42°
AD 4	AC 35	1,810					3,50	4,20	4,80	68°	60°
AD 5	AC 35	2,310	2,60	3,00	3,30	3,60	4,50	5,50	6,30	69°	62°
AD 2	AC 56	1,180	0,98	1,10	1,20	1,40	1,80	2,20	2,50	18°	16°
AD 3	AC 56	1,385	1,30	1,60	1,70	1,90	2,40	3,00	3,40	24°	22°
AD 4	AC 56	1,810	2,20	2,50	2,80	3,10	4,00	4,80	5,60	30°	28°
AD 5	AC 56	2,310	3,00	3,50	3,90	4,30	5,50	6,70	7,80	35°	33°
AD 6	AC 56	2,770	4,50	5,30	5,90	6,50	8,50	10,2	11,9	40°	38°
AD 7	AC 56	3,230	6,00	6,90	7,70	8,50	11,0	13,5	15,6	53°	51°

 DISCO AD
 DIFUSOR AC

2,80
4,20

CONSULTE PRECIOS SEGÚN CANTIDADES



BOQUILLAS DE PULVERIZACIÓN

Calidad acreditada bajo los requisitos
BBA (Instituto Biológico Alemán) y CEN
(Organización Europea de Normalización)



CON BOQUILLAS CADA 50cm

	 bar	 l/min	l/ha						
			6 km/h	8 km/h	10 km/h	12 km/h	14 km/h	16 km/h	18 km/h
ISO 01	2	0.33	66	50	40	33	28	25	22
	2.5	0.37	74	56	44	37	32	28	25
	3	0.40	80	60	48	40	34	30	27
	3.5	0.43	86	65	52	43	37	32	29
ISO 015	4	0.46	92	69	55	46	39	35	31
	2	0.49	98	74	59	49	42	37	33
	2.5	0.55	110	83	66	55	47	41	37
	3	0.60	120	90	72	60	51	45	40
ISO 02	3.5	0.65	130	98	78	65	56	49	43
	4	0.69	138	104	83	69	59	52	46
	2	0.65	130	98	78	65	56	49	43
	2.5	0.73	146	110	88	73	63	55	49
ISO 025	3	0.80	160	120	96	80	69	60	53
	3.5	0.86	172	129	103	86	74	65	57
	4	0.92	184	138	110	92	79	69	61
	2	0.82	164	123	98	82	70	62	55
ISO 03	2.5	0.91	182	137	109	91	78	68	61
	3	1.00	200	150	120	100	86	75	67
	3.5	1.08	216	162	130	108	93	81	72
	4	1.15	230	173	138	115	99	86	77
ISO 04	2	0.98	196	147	118	98	84	74	65
	2.5	1.10	220	165	132	110	94	83	73
	3	1.20	240	180	144	120	103	90	80
	3.5	1.30	260	195	156	130	111	98	87
ISO 05	4	1.39	278	209	167	139	119	104	93
	2	1.31	262	197	157	131	112	98	87
	2.5	1.46	292	219	175	146	125	110	97
	3	1.60	320	240	192	160	137	120	107
ISO 06	3.5	1.73	346	260	208	173	148	130	115
	4	1.85	370	278	222	185	159	139	123
	2	1.63	326	245	196	163	140	122	109
	2.5	1.83	366	275	220	183	157	137	122
ISO 08	3	2.00	400	300	240	200	171	150	133
	3.5	2.16	432	324	259	216	185	162	144
	4	2.31	462	347	277	231	198	173	154
	2	1.96	392	294	235	196	168	147	131
ISO 10	2.5	2.20	440	330	264	220	189	165	147
	3	2.40	480	360	288	240	206	180	160
	3.5	2.60	520	390	312	260	223	195	173
	4	2.80	560	420	336	280	240	210	187
ISO 15	2	2.61	522	392	313	261	224	196	174
	2.5	2.92	584	438	350	292	250	219	195
	3	3.20	640	480	384	320	274	240	213
	3.5	3.46	692	519	415	346	297	259	231
ISO 15	4	3.70	740	555	444	370	317	277	247
	2	3.27	654	491	392	327	280	245	218
	2.5	3.65	730	548	438	365	313	274	243
	3	4.00	800	600	480	400	343	300	267
ISO 15	3.5	4.32	864	648	518	432	370	324	288
	4	4.62	924	693	554	462	396	347	308
	2	4.90	980	735	588	490	420	368	327
	2.5	5.48	1096	822	658	548	470	411	365
ISO 15	3	6.00	1200	900	720	600	514	450	400
	3.5	6.48	1296	972	778	648	555	486	453
	4	6.93	1386	1040	832	693	594	520	462

2022



TABLAS CAUDALES ESPECIFICAS



A P M

bar	l/mn						
	AMARILLA	NARANJA	ROJA	VERDE	AZUL	GRIS	NEGRA
0,5	0,39	0,64	0,97	1,30	1,62	2,30	3,00
1	0,55	0,91	1,37	1,84	2,29	3,25	4,24
1,5	0,67	1,12	1,68	2,25	2,80	3,98	5,19
2	0,78	1,29	1,94	2,60	3,23	4,60	6,00
2,5	0,87	1,44	2,17	2,90	3,61	5,14	6,70
3	0,95	1,58	2,38	3,18	3,96	5,63	7,24
3,5	1,03	1,71	2,57	3,43	4,26	6,08	7,93
4	1,10	1,82	2,74	3,68	4,58	6,50	8,48

ANGULOS VARIABLES DE 30° A 160° SEGÚN COLOR Y PRESIÓN



E X A

bar	l/mn							
	AMARILLA	ROJA	VERDE	AZUL	BLANCA	MARRÓN	GRIS	NEGRA
1	0,35	0,59	0,67	0,86	1,39	1,90	2,25	3,00
1,5	0,43	0,71	0,81	1,03	1,63	2,24	2,63	3,51
2	0,50	0,80	0,92	1,17	1,83	2,51	2,95	3,93
2,5	0,56	0,89	1,01	1,29	2,00	2,74	3,21	4,28
3	0,61	0,97	1,10	1,40	2,15	2,95	3,45	4,60
3,5	0,66	1,04	1,18	1,50	2,29	3,14	3,66	4,89



A T R

bar	l/mn									
	BLANCA	LILA	CAFE	AMARILLA	NARANJA	ROJA	GRIS	VERDE	NEGRA	AZUL
5	0,27	0,36	0,48	0,73	0,99	1,38	1,50	1,78	2,00	2,45
6	0,29	0,39	0,52	0,80	1,08	1,51	1,63	1,94	2,18	2,67
7	0,32	0,42	0,56	0,86	1,17	1,62	1,76	2,09	2,35	2,87
8	0,34	0,45	0,60	0,92	1,24	1,73	1,87	2,22	2,50	3,06
9	0,36	0,48	0,64	0,97	1,32	1,83	1,98	2,35	2,64	3,24
10	0,38	0,50	0,67	1,03	1,39	1,92	2,08	2,47	2,78	3,40
11	0,39	0,52	0,70	1,07	1,45	2,01	2,17	2,58	2,90	3,56
12	0,41	0,55	0,73	1,12	1,51	2,09	2,26	2,69	3,03	3,71
13	0,43	0,57	0,76	1,17	1,57	2,17	2,35	2,79	3,14	3,85
14	0,44	0,59	0,79	1,21	1,63	2,25	2,43	2,89	3,26	3,99
15	0,46	0,61	0,81	1,25	1,69	2,33	2,51	2,99	3,36	4,12
16	0,47	0,63	0,84	1,29	1,74	2,40	2,59	3,08	3,47	4,25
17	0,48	0,64	0,86	1,33	1,79	2,47	2,67	3,17	3,57	4,37
18	0,50	0,66	0,89	1,37	1,84	2,54	2,74	3,25	3,67	4,49
19	0,51	0,68	0,91	1,40	1,89	2,60	2,81	3,34	3,76	4,61
20	0,52	0,70	0,93	1,44	1,94	2,67	2,88	3,42	3,85	4,72
21	0,54	0,71	0,95	1,48	1,99	2,73	2,95	3,50	3,94	4,84
22	0,55	0,73	0,98	1,51	2,03	2,79	3,01	3,57	4,03	4,94
23	0,56	0,74	1,00	1,54	2,07	2,85	3,07	3,65	4,12	5,05
24	0,57	0,76	1,02	1,58	2,12	2,91	3,14	3,72	4,20	5,15
25	0,58	0,77	1,04	1,61	2,16	2,97	3,20	3,80	4,28	5,25



TABLAS CAUDALES ESPECIFICAS

APE ALBUZ



bar	l/mn								
	AMARILLA	NARANJA	ROJA	VERDE	AZUL	GRIS	NEGRA	MARFIL	BLANCA
2	0,49	0,69	0,99	1,40	1,98	2,79	3,95	5,61	7,82
2,5	0,55	0,77	1,11	1,57	2,21	3,11	4,41	6,28	8,85
3	0,61	0,85	1,21	1,71	2,42	3,41	4,83	6,88	9,70
3,5	0,65	0,92	1,31	1,85	2,62	3,69	5,22	7,43	10,48
4	0,70	0,98	1,40	1,98	2,80	3,94	5,58	7,94	11,20

DISCO AMT - SENTIDO "A"



bar	l/mn								
	..007	..008	..010	..012	..015	..018	..020	..023	..040
2	0,42	0,54	0,91	1,14	1,88	2,54	3,09	3,98	12,28
3	0,51	0,66	1,10	1,39	2,27	3,12	3,77	4,91	15,06
4	0,59	0,75	1,25	1,6	2,6	3,60	4,35	5,70	17,40
5	0,65	0,83	1,38	1,78	2,89	4,03	4,86	5,40	19,46
10	0,91	1,15	1,89	2,51	3,99	5,70	6,85	9,17	27,56
15	1,10	1,39	2,27	3,06	4,82	6,98	8,37	11,31	33,78
20	1,27	1,59	2,59	3,52	5,51	8,06	9,65	13,13	39,03
30	1,54	1,92	3,11	4,30	6,65	9,88	11,80	16,20	47,84
50	1,96	2,43	3,91	5,52	8,44	12,76	15,20	21,12	61,83

DISCO AMT - SENTIDO "B"



bar	l/mn								
	..007	..008	..010	..012	..015	..018	..020	..023	..040
2	0,41	0,43	0,65	0,94	1,42	1,98	2,46	3,18	10,13
3	0,50	0,53	0,79	1,15	1,73	2,42	3,02	3,90	12,41
4	0,57	0,61	0,91	1,32	2,00	2,80	3,50	4,50	14,33
5	0,64	0,68	1,01	1,47	2,23	3,13	3,92	5,03	16,03
10	0,89	0,95	1,42	2,07	3,15	4,43	5,58	7,12	22,08
15	1,08	1,16	1,74	2,53	3,85	5,42	6,87	8,72	27,79
20	1,24	1,34	2,00	2,92	4,44	6,26	7,95	10,07	32,09
30	1,50	1,63	2,44	3,56	5,43	7,67	9,78	12,33	39,32
50	1,92	2,09	3,13	4,58	6,99	9,90	12,68	15,92	50,79

2022

BOQUILLAS DE PULVERIZACIÓN HYPRO
X X X X X X X TIENDA SUS POSIBILIDADES DE TRATAMIENTO



La serie XT ofrece la tecnología de distribución homogénea SIN barras, con un ancho de tratamiento de hasta 4,9mts permitiendo que la pulverización llegue a objetivos inalcanzables con las Barras tradicionales u otros tipos de boquillas.

XT - Para Aplicaciones de Cobertura Total en Banda y Dirigidas.

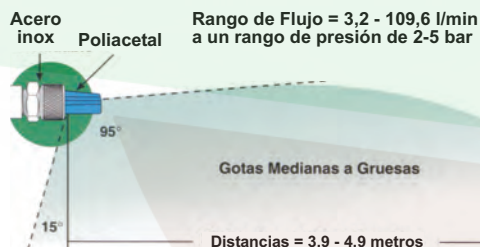
- Abanico plano descentrado Off-centre 15°/95°
- Tamaño medio de gota mediano o grueso.
- Alto caudal l/min.
- Amplia cobertura con patrón de distribución uniforme.

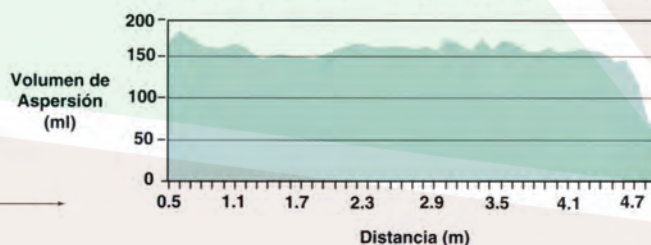

Patrón de Aspersión Típico Producido por las Boquillas Serie XT

Características:

- Orificio moldeado de alta precisión en poliacetal
- Cuerpo reforzado rosca macho INOX para XT
- Tuerca bayoneta integrada para XT .. FC
- 8 Tamaños de boquilla que cubren las máximas necesidades de aplicación.
- La cobertura de la boquilla es uniforme en rangos de trabajo de 2 a 5 Atm.
- Gotas gruesas que reducen la deriva y facilitan la penetración en el cultivo.
- Fácil instalación y bajo mantenimiento.

APLICACIONES de fungicidas, insecticidas y fertilizantes



BOQUILLAS DE PULVERIZACIÓN **HYPRO**



CÓDIGO	DESCRIPCIÓN	P.V.P. €
18024080 + COLOR + 110	XT	
	XT - 010 - 020 - 024 -	63,00
	CONEXIÓN INOX	
	XT - 043 - 080	115,00
	XT - 167 - XT215	150,00



CÓDIGO	DESCRIPCIÓN	P.V.P. €
18024081 + COLOR + 110	XT FC	
	010FC - 015FC - 020FC- 024FC- 043FC CON TUERCA BAYONETA	31,00



CÓDIGO	DESCRIPCIÓN	P.V.P. €
18024000	KITS RECAMBIO PARA XT	
	BOQUILLA + INSERTO INOX + OR	27,00
	XT010G - XT020G - XT024G	
	XT043G	33,00
	XT080G - XT167G	57,00

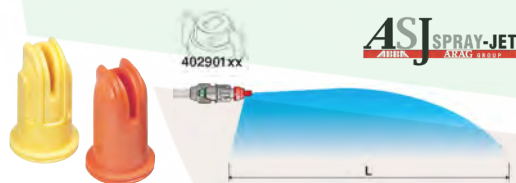

CÓDIGO	DESCRIPCIÓN	P.V.P. €
180180800 + COLOR	422 BX - BOQUILLA LARGO ALCANCE DE CHORRO LATERAL - INSERTO DE CERÁMICA PARA MAYOR DURACIÓN -	13,50

Inserto cerámico Ceramic insert Inserto cerámico	COD. CODE COD.	drop	bar	L/min	L	l/ha									
						4 km/h	6 km/h	8 km/h	10 km/h	12 km/h	14 km/h	16 km/h	18 km/h	20 km/h	
✓	422BX010	UC	2	3,2	2,1	227	152	114	91	76	65	57	51	45	
		UC	3	3,9	2,6	225	150	113	90	75	64	56	50	45	
		UC	4	4,5	3,1	218	145	109	87	73	62	54	48	44	
		XC	5	5,0	3,9	194	129	97	77	65	55	48	43	39	
		XC	6	5,5	4,4	188	125	94	75	63	54	47	42	38	
		UC	2	6,5	2,8	346	230	173	138	115	99	86	77	69	
✓	422BX020	UC	2	7,9	3,2	370	247	185	148	123	106	93	82	74	
		UC	4	9,1	3,5	391	261	195	156	130	112	98	87	78	
		UC	5	10,2	3,7	413	276	207	165	138	118	103	92	83	
		XC	6	11,2	4,0	419	279	209	168	140	120	105	93	84	
		UC	2	7,7	2,5	461	307	230	184	154	132	115	102	92	
		UC	3	9,4	3,0	470	313	235	188	157	134	118	104	94	
✓	422BX025	UC	4	10,9	3,3	493	329	247	197	164	141	123	110	99	
		UC	5	12,1	3,5	520	347	260	208	173	149	130	116	104	
		XC	6	13,3	3,6	554	369	277	222	185	158	138	123	111	
		UC	2	14,1	2,9	731	487	365	292	244	209	183	162	146	
		UC	3	17,3	3,0	865	577	433	348	288	247	216	192	173	
		UC	4	20,0	3,3	906	625	454	363	303	259	227	202	182	
✓	422BX045	UC	5	22,3	3,5	957	638	479	383	319	273	239	213	191	
		UC	6	24,5	3,6	1019	680	510	408	340	291	255	227	204	
		UC	2	18,1	3,0	905	604	453	363	302	259	227	201	181	
		UC	3	22,2	3,4	979	653	490	392	326	280	245	218	196	
		UC	4	25,6	4,0	961	641	481	385	320	275	240	214	192	
		UC	5	26,7	4,4	977	651	489	391	326	279	244	217	195	
X	422BX060	UC	6	31,4	4,7	1002	688	501	401	334	288	250	223	200	
		UC	2	25,3	3,5	1085	723	542	434	362	310	271	241	217	
		UC	3	31,0	4,0	1169	775	581	465	388	332	291	258	233	
		UC	4	35,8	4,0	1342	895	671	537	447	384	336	298	268	
		UC	5	40,0	4,1	1464	976	732	586	486	418	366	325	293	
		UC	6	43,8	4,1	1604	1069	802	642	535	458	401	356	321	

XC - EXTRAMADAMENTE GRUESA 428 µm a 622 µm UC - ULTRA GRUESA > 622 µm

BOQUILLAS DE PULVERIZACIÓN **HYPRO**

XT Modelo	CAUDALES		APLICACIÓN (l/ha) Kilometros hora											COBERTURA (m) 3 bar - 1.2m H
	Bar	l/min	4	5	6	7	8	10	12	14	16	18	20	
XT010 - 1/4" FC-XT010	2	3,2	124	99	83	71	62	50	41	35	31	28	25	3,9
	3	3,9	152	121	101	87	76	61	51	43	38	34	30	
	4	4,6	175	140	117	100	88	70	58	50	44	39	35	
FC-XT015 1/4"	2	4,6	162	129	108	92	81	65	54	46	40	36	32	4,3
	3	5,7	198	159	132	113	99	79	66	57	50	44	40	
	4	6,6	229	183	153	131	114	92	76	65	57	51	46	
XT020 - 1/4" FC-XT020	2	6,4	201	161	134	115	101	81	67	58	50	45	40	4,8
	3	7,9	247	197	165	141	123	99	82	71	62	55	49	
	4	9,1	285	228	190	163	142	114	95	81	71	63	57	
XT024 - 1/4" XT024FC	2	7,7	237	189	158	135	118	95	79	68	59	53	47	4,9
	3	9,5	290	232	193	166	145	116	97	83	73	64	58	
	4	10,9	335	268	223	191	167	134	112	96	84	74	67	
XT043 - 3/8" FC-XT043	2	13,9	473	378	315	270	236	189	158	135	118	105	95	4,4
	3	17	579	463	386	331	289	232	193	165	145	129	116	
	4	19,6	668	535	446	382	334	267	223	191	167	149	134	
XT080 - 1/2"	2	25,8	992	793	661	567	496	397	331	283	248	220	198	3,9
	3	31,6	1215	972	810	694	607	486	405	347	304	270	243	
	4	36,5	1403	1122	935	802	701	561	468	401	351	312	281	
XT167 - 3/4"	2	53,8	1878	1502	1252	1073	939	751	626	537	469	417	376	4,3
	3	65,9	2300	1840	1533	1314	1150	920	767	657	575	511	460	
	4	76,1	2656	2125	1771	1518	1328	1062	885	759	664	590	531	
XT215 - 3/4"	2	69,3	2122	1697	1414	1212	1061	849	707	606	530	471	424	4,9
	3	84,9	2598	2079	1732	1485	1299	1039	866	742	650	577	520	
	4	98	3000	2400	2000	1715	1500	1200	1000	857	750	667	600	



ACCESORIOS

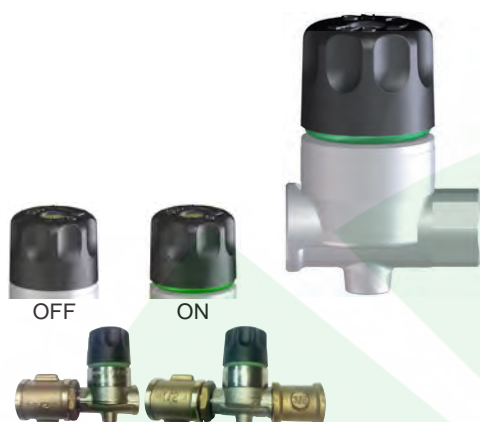

CÓDIGO	DESCRIPCION	P.V.P. €
831007.5	MODULO ANTIGOTA Y CIERRE 1/4" -1/4" H-H-	15,00
831007.15	MODULO ANTIGOTA Y CIERRE 1/4" -1/4" M-H	15,00
831071.7GH	MODULO ANTIGOTA Y CIERRE 1/4"-3/8" M-M	17,80
831007.25	COMBI ANTIGOTA Y CIERRE 1/2"-1/4" H-H	17,80
831071.35	COMBI ANTIGOTA Y CIERRE 1/2"-3/8" H-H	21,80

MÓDULO ANTIGOTA



CÓDIGO	ENTRADA	SALIDA	P.V.P. €
006 201	1/4 M	1/4 H	9,20
006 202	1/4 H	1/4 H	8,45
006 203	3/8 M	1/4 H	9,74
006 204	1/2 M	1/4 H	9,80
006 205	1/2 H	1/4 H	12,50

JETS TERMINALES C/ANTIGOTA Y CIERRE



CÓDIGO	DESCRIPCION	P.V.P. €
4065 845C	ORIENTABLE CONEXIÓN EASYFIT PARA TUBO 1/2	14,43
4065 445C	ROSCA HEMBRA 1/2"	13,09

CÓDIGO	DESCRIPCION	P.V.P. €
400 277	TERMINAL ROSCADO H 1/2"	1,70
400 278	TERMINAL ROSCADO H 3/4"	1,91
402 901 03	TUERCA ATT RAP P/BX	0,56
402 910 01	TUERCA ATT RAPIDO ROSCA 1/4 "	1,12
400 64B	CONEXIÓN ALIMENTACION BARRA AGUJERO D. 14 P/ TUBO 1/2"	3,57



AGITADORES HIDRAULICOS



DESCRIPCIÓN	CÓDIGO	P.V.P. €
AGITADOR HIDRAULICO CURVO boquilla acero inoxidable (Ø 1,2 mm.)	502 010	7,25



DESCRIPCIÓN	CÓDIGO	P.V.P. €
AGITADOR HIDRAULICO RECTO boquilla acero inoxidable (Ø 1,2 mm.)	502 020	7,11



DESCRIPCIÓN	BOQUILLA		CÓDIGO	P.V.P. €
	Ø			
AGITADOR HIDRAULICO CURVO INSPECCIONABLE	1,2	CERAMICA	502 20312	8,30
	1,5		502 20315	
	2,0		502 2032	
	3,0	INOX	502 2033	



DESCRIPCIÓN	BOQUILLA		CÓDIGO	P.V.P. €
	Ø			
AGITADOR HIDRAULICO RECTO INSPECCIONABLE	1,2	CERAMICA	502 20412	7,74
	1,5		502 20415	
	2,0		502 2042	



DESCRIPCIÓN	BOQUILLA		CÓDIGO	P.V.P. €
	Ø			
AGITADOR HIDRAULICO CURVO ANTI-ESPUMA	1,5	CERAMICA	502 21315	8,87
	3,0	INOX	502 2133	



DESCRIPCIÓN	BOQUILLA		CÓDIGO	P.V.P. €
	Ø			
AGITADOR HIDRAULICO RECTO ANTI-ESPUMA	2,0	CERAMICA	502 2142	8,53

**DISPONIBLES OTRAS MEDIDAS Y MODELOS,
CONSULTAR CATÁLOGO TÉCNICO.**

2022



HIDROCARGADORES

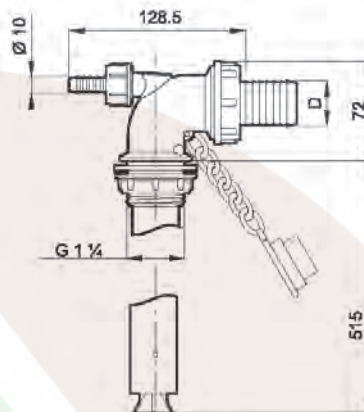
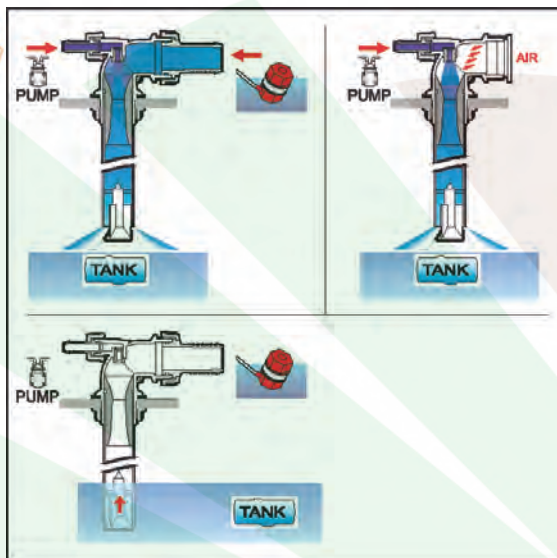

DESCRIPCIÓN	CÓDIGO	D mm	Ø Chiclé	Presión bar	P.V.P. €
Hidrocargador anticontaminante Enlace roscado. Puede utilizarse como eficaz mezclador	500 340	40	3,2	15~40	22,82
	500 332	32			22,82
	500 240	40	5	10~25	22,82
	500 232	32			22,82



DESCRIPCIÓN	CÓDIGO	P.V.P. €
HIDROCARGADOR CON FILTRO INOX CON CONEXION ROSCADA M 1" 1/4	500 415	28,14

2022



ACCESORIOS

VALVULA DESCARGA 2"



CÓDIGO	P.V.P. €
452 107	21,01

BRIDAS ATOMIZADOR CON JUNTA



CÓDIGO		P.V.P. €
006 010	LATON	41,00
006 020	NYLON	17,96

VALVULA COMPUERTA



CÓDIGO			P.V.P. €
450 017	2 "	M - M	28,12
450 025	1" 1/4	M - H	28,12
450 027	2 "		
450 035	1" 1/4	H - H	28,12
450 036	1" 1/2		
450 037	2"		

GRIFO LAVA MANOS 3/4"

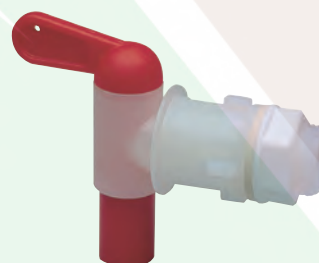

CÓDIGO		P.V.P. €
555 3018	SALIDA 17,5	2,71
555 3009	SALIDA 8,5	

ESCUDO ANTIHOJAS 980x225 mm

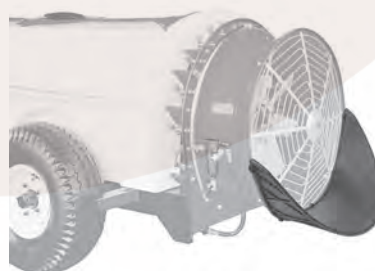

CÓDIGO	P.V.P. €
509 301	57,07

2022



INDICADORES DE NIVEL

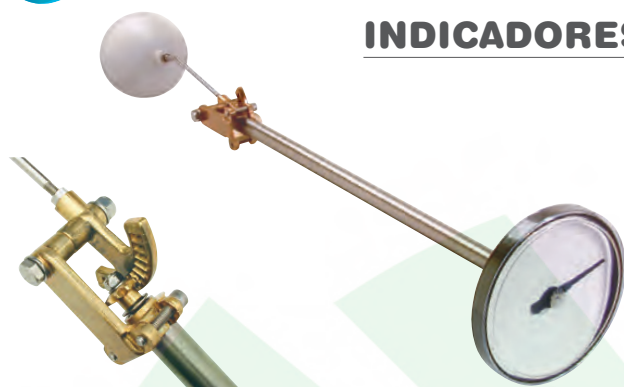

**INDICADOR NIVEL
MECANICO
VISOR CIRCULAR 340 °
TRANSMISION MECANICA
DE LATON E INOX
ESTÁNDAR Y CON
PASATABIQUES**

*ESCALA GRADUADA, A
EJECUTAR DE ACUERDO A LA
CONFIGURACION DEL
DEPOSITO - **NO INCLUIDA**

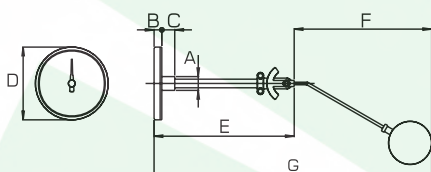

LARGO PASATABIQUES

MODELO	CÓDIGO	VARILLA mm	D	B	C	A	E	P.V.P. €
ESTÁNDAR	11.500 000	585 incluida	170	18	30	1"	560	110,00
LARGO PASATABIQUES	11.503 001	745 incluida					750	140,00
VARILLA L-585 - OPCIONAL-	11.500 240	585						7,90
VARILLA L-640 - OPCIONAL -	11.500 242	640						12,25
VARILLA L-760 - OPCIONAL -	11.500 243	760						14,20
TAPA TRANSPARENTE	11.500 040							8,10

INDICADOR NIVEL CON TUBO

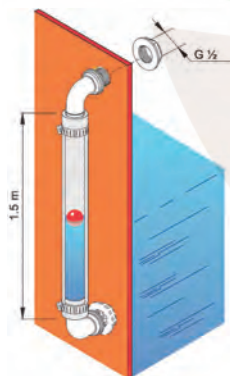

	CÓDIGO	P.V.P. €
KIT INDICADOR C/TUBO D. 19	509 219	12,77
BOLA D. 11,5 C/AGUJERO	509.219.010	0,49
BOLA D.15,5 C/AGUJERO	07.168 160419	0,70

INDICADOR NIVEL FRONTAL



	CÓDIGO	P.V.P. €
KIT CUERPO + TAPA + FUELLE	508 010	27,81
BOYA PLANA - NO INCLUIDA-	508 020	6,60



**MEZCLADORES Y ROBOTS
- POLVO-**



(A)



(B)



MODELO	CÓDIGO	P.V.P. €
ROBOT GIRATORIO 230 ° MEZCLADOR POLVO (A)		
PARA MONTAJE A CESTA FILTRO	11.800 001	27,00
PRESIÓN 10 A 30 BAR - Caudal 45 l/mn a 10 bar		
MEZCLADOR TIPO PARAGÜAS P/POLVO (B)	502 001	14,82

- LIMPIEZA DEPÓSITOS -



(A)



(B)

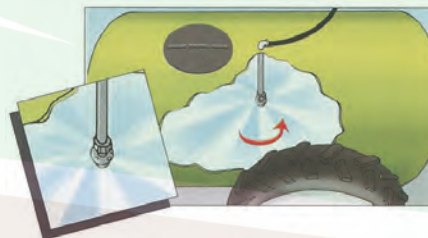

(C)

MODELO	CÓDIGO	P.V.P. €
ROBOT GIRATORIO 360 ° LIMPIEZA DEPOSITO (A)		
PRESIÓN 10 A 30 BAR - Caudal 45 l/mn a 10 bar	11.800 000	27,00
CONEXIÓN 1/2" - EJE LATON		
GET GIRATORIO 360° - Conexión Ø 13 (C)	634 08399	36,00
GET LAVA DEPOSITOS 360 ° BAJA PRESION (B)		
3 bar - 200 rpm - Caudal 57 l/mn - Conexión 1/2 H	510 121	28,14

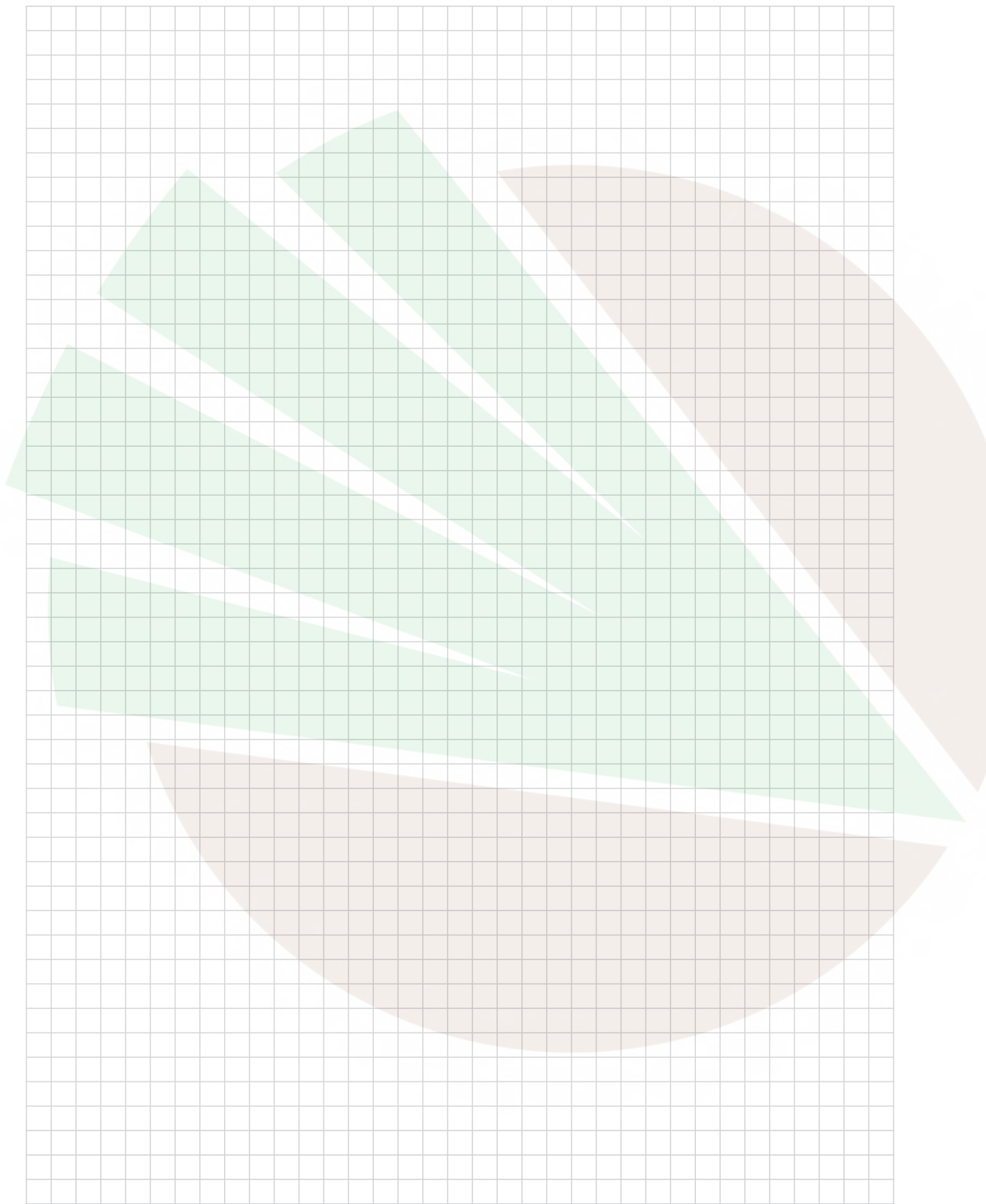



TAPAS DEPÓSITOS

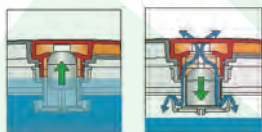

MODELO	CÓDIGO	Ø TAPA	P.V.P. €
TAPA ABATIBLE 180° CON ARO Y JUNTA	356 040	367	21,63
VALVULA DE AIREACIÓN FLOTANTE CIERRE TIPO BAYONETA DE 6 PUNTOS	356 060	462	25,75

JUNTA DE RECAMBIO EN NBR	356 2040.090	367	7,12
	356 2060.090	462	8,41

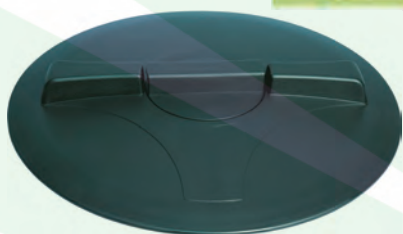

MODELO	CÓDIGO	Ø TAPA	P.V.P. €
TAPA ROSCADA CON VALVULA RESPIRADERO	352 2000	140	5,13
GRUPO VALVULA MISTRAL EXTRAIBLE	352 2040	355	11,26
DE DOBLE RESPIRADERO	352 2060	455	13,66
	352 2080	620	36,05



MODELO	CÓDIGO	Ø TAPA	P.V.P. €
TAPA ROSCADA CON RESPIRADERO FIJO	352 2221	250	7,76
RESPIRADERO DE LABERINTO GHIBLI	352 2241	355	10,59
	352 2261	455	12,90

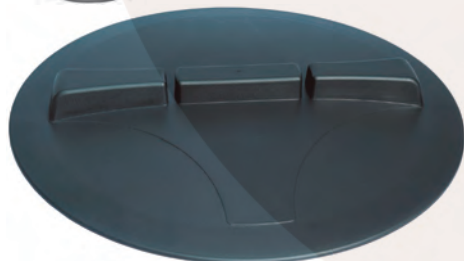

MODELO	CÓDIGO	Ø TAPA	P.V.P. €
TAPA ROSCADA CIEGA SIN RESPIRADERO	352 2100	140	3,50
	352 2120	250	6,23
	352 2140	355	10,27
	352 2160	455	12,57
	352 2180	620	34,63

JUNTA NBR ENTRE TAPA/ARO - OPCIONALES

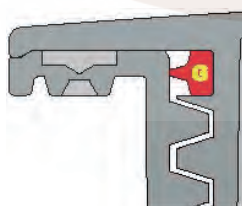

CÓDIGO	Ø TAPA	P.V.P. €
352 000 021	140	1,31
352 2120 020	250	3,82
352 2140 020	355	5,68
352 2160 020	455	7,44



AROS PARA TAPAS DEPÓSITOS

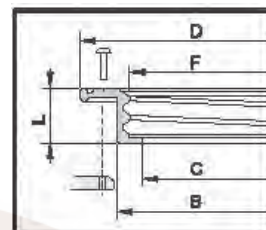

MODELO	CÓDIGO	B mm	C mm	D mm	L mm	PARA TAPA Ø	P.V.P. €
ARO ROSCADO PARA SUPERFICIES PLANAS	350 2420	215	192	255	38	Ø 250	3,61
	350 2440	320	290	360	38	Ø 355	4,84
	350 2460	415	382	462	35	Ø 455	5,56
	350 480	575	540	620	41	Ø 620	14,78
ARO ROSCADO P / TAPA / VÁLVULA	350 401	125		159	17	Ø 140	2,42

JUNTA OR DE ESTANQUEIDAD ENTRE DEPOSITO Y ARO

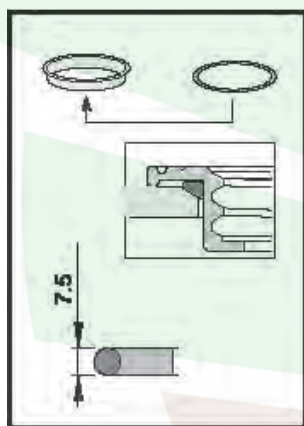

MODELO	PARO ARO	P.V.P. €
350 401.020	350 401	2,32
350 420.020	350 2420	2,63
350 440.020	350 2440	3,30
350 460.020	350 2460	3,91
350 480.020	350 480	6,03

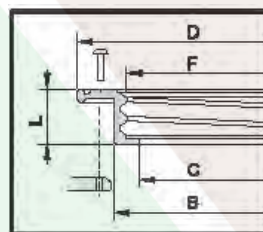

MODELO	CÓDIGO	B mm	D mm	L mm	PARA TAPA Ø	P.V.P. €
ARO ROSCADO PARA SUPERFICIES PLANAS CON DOBLE JUNTA	350 620	215	255	38	Ø 250	8,34
	350 640	320	360	38	Ø 355	10,92
	350 660	415	462	35	Ø 455	12,93
	350 680	575	620	41	Ø 620	23,18

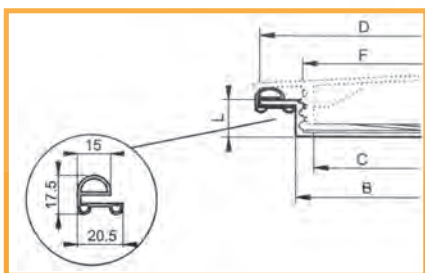

RECAMBIOS				
	JUNTA		ARO	
Ø	CÓDIGO	P.V.P €	CÓDIGO	P.V.P. €
255	350 620.020	4,07	350 2420	3,61
355	350 640.020	5,25	350 640.010	6,00
455	350 660.020	6,28	350 660.010	7,30
620	350 680.020	10,51	350 680.010	18,20



FILTROS CESTA 18 Mesh

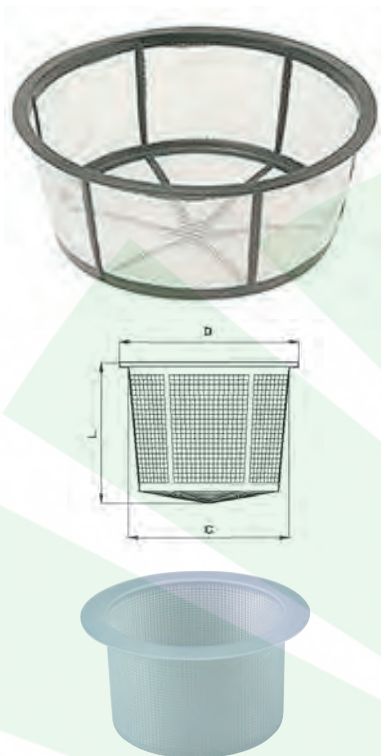

CODIGO	D mm	C mm	L mm	PARA TAPAS Ø	P.V.P. €
300 110	203	188	120	250	10,38
300 116			235		13,42
300 120	300	288	245	355	15,48
300 126	400	380	185	455	16,45
300 130			275		18,73
300 134			330		24,45
300 119	230	188	235	---	13,74
300 140	140	127	203	140	10,30

FILTROS DE TAZA

CODIGO	D mm	C mm	L mm	PARA TAPAS Ø	P.V.P. €
300 304	118	108	40	140	3,57
300 315	204	187	60	250	3,46
300 330	302	288	46	355	5,62
300 320	208	194	40	---	3,68

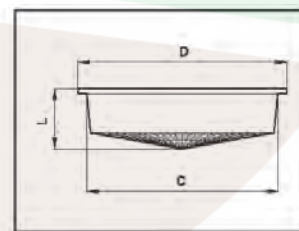

CESTO INOX



CODIGO	MODELO
006 960	400x382x333 ø 26 mm

BAJO PEDIDO



TAPAS ROSCADAS CON JUNTA

TAPA CERRADA

JUNTA OPCIONAL



354 120

**TAPA CON
MEMBRANA DE
RESPIRADERO
COMPLETO CON
JUNTA**



354 230

**TAPA CERRADA
CON JUNTA**



354 130

**TAPA CON
RESPIRADERO
DE MUELLE CON
JUNTA**



354 2010

**TAPA CERRADA
CON JUNTA**



354 2110

**TAPA CERRADA
MACHO**

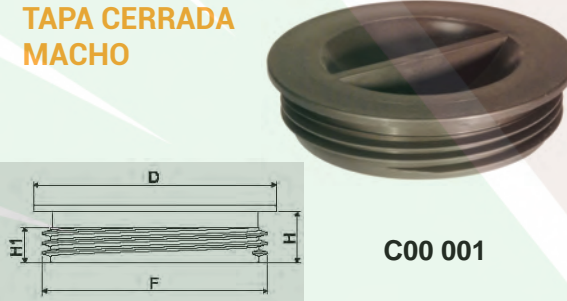

C00 001

COD.	D mm	F mm	H mm	JUNTA	P.V.P. €
354 120	240	220 (8,6")	58,5	0	4,91
354 230	122	106 (4,1")	36,5	1	3,91
354 130	122	106 (4,1")	32	1	2,84
354 2010	166	152 (6")	47	2	5,05
354 2110	166	152 (6")	47	2	3,81
C00001	137	127	30/21	-	3,89

FILTRO
D 140xC127xL203 mm

**PARA TAPAS
354 2110
354 2010**



CÓDIGO		P.V.P. €
300140	FILTRO CESTA	10,38
0 G11 069	JUNTA OR - OPCIONAL	2,24
1 354.030.020	JUNTA DE RECAMBIO	1,20
2 354.2010.020	JUNTA DE RECAMBIO	1,80



TAPA ROSCADA CON JUNTA

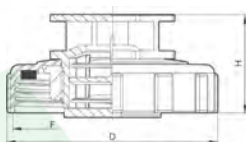
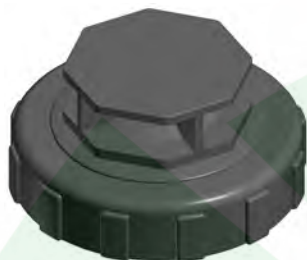

CÓDIGO	DESCRIPCIÓN	P.V.P. €
354231	TAPA CON VÁLVULA RESPIRADERO DE LABERINTO Y JUNTA D - 122 // H 57 // F 113 junta 354030.020	9,84

RÁCORES PARA DEPOSITOS INDUSTRIALES "IBC"

ADAPTADORES ROSCA HEMBRA BUTTRESS 2" (S60X6)



CUERPO PP REFORZADO - JUNTAS SANTOPRENE

CÓDIGO	SALIDA	P.V.P. €
TA283	2" MACHO - NPT	24,25
TA283 QD	2" MACHO CAM LOK	19,10



CUERPO PP JUNTAS EPDM

CÓDIGO	SALIDA	P.V.P. €
550 604	1" BSP	15,45
550 606	1" 1/2 BSP	18,23
550 607	2" BSP	19,36



VÁLVULAS DE RESPIRADERO

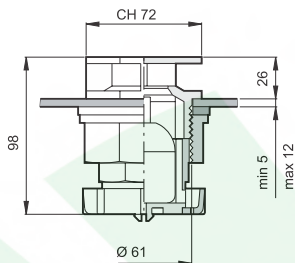

MODELO	CÓDIGO	P.V.P. €
VÁLVULA RESPIRADERO DE BOLA FLOTANTE	504 210	6,60

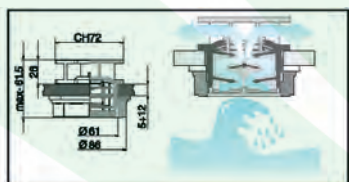

VÁLVULA RESPIRADERO LABERINTO	504 220	6,39
-------------------------------	---------	------

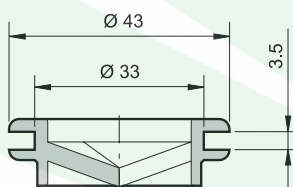
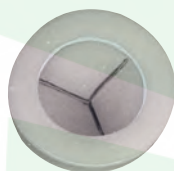

VÁLVULA DE P.V.C	504 201	1,11
------------------	---------	------

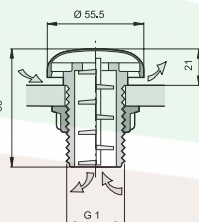

VÁLVULA RESPIRADERO DE LABERINTO	504 203	3,62
----------------------------------	---------	------

VÁLVULAS RESPIRADERO - DOBLE EFECTO -

*POLIETILENO COMPATIBLE PARA CONTACTO CON ALIMENTOS
*JUNTAS NBR

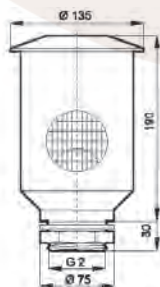

CÓDIGO	P.V.P. €
550 036	31,83

2022



INCORPORADORES PRODUCTO MIXER

EVITAN LA MANIPULACIÓN DIRECTA DEL PRODUCTO QUÍMICO, PERMITEN:

- MEZCLA DEL PRODUCTO CON AGUA
- TRASVASE AL DEPÓSITO PRINCIPAL
- LIMPIEZA DEL RECIPIENTE DE PRODUCTO ACTIVO

MIXER STANDARD



20 LTS

- * APTOS PARA LIQUIDOS – POLVO – GRANULADOS BOLSAS HIDROSOLUBLES.
- * DEPOSITOS POLIETILENO DE 20 / 30 LTS.
- * COLECTORES MANDOS Y DESCARGA REFORZADOS ACCESIBLES Y DE RAPIDO ACCIONAMIENTO.
- * GET ROTATIVO LAVA CONTENEDORES Y ENJUAGUE INTERIOR.
- * MIRILLA PARA INSPECCION INTERIOR Y EMBUDO RAPIDO, SOLO MOD. ESTÁNDAR.
- * SOPORTE DE ACERO TRATADO POR CATOFORRESIS O PINTADO ALTA RESISTENCIA.
- * TAPAS DE GRAN DIMENSION PARA FACILITAR LA INTRODUCCION DEL PRODUCTO QUIMICO.

NIAGARA

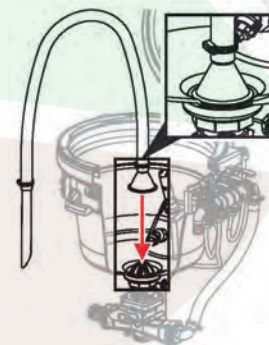
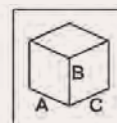

CÓDIGO	DESCRIPCIÓN	CAPACIDAD LT	TAPA MM	MEDIDAS A*B*C	PESO KG	P.V.P €
0018.1402	MIXER ESTÁNDAR	20	430 x 350	436x550X357	10	670,00
503 3201	NIAGARA	20	Ø 355	487X612X462	8	691,00
503 3301		30	Ø 455	575x618x542	10	713,00
503 3000	KIT ASPIRACION P/NIAGARA CON TUBO 1,5 m					39,25



JET LAVA-CONTENEDORES

510 111



- LIMPIA LOS CONTENEDORES VACÍOS (BOTELLAS-TANQUES).
- REDUCE EL DESPERDICIO DE PRODUCTO.
- CON FILTRO A MALLA PARA EVITAR EL BLOQUEO CAUSADO POR LA SUCIEDAD.
- CABEZAL ROTATIVO ACCIONADO POR EL FLUIDO.
- VÁLVULA DE SEGURIDAD (SE ABRE SÓLO PRESIONANDO EL CONTENEDOR)

CÓDIGO	P.V.P €
510 111	25,97
510 101	16,67



510 101



- GIRATORIO 360° PARA UNA LIMPIEZA COMPLETA.
- CON PUNTAS P/ROMPER LA PELICULA DE PROTECCIÓN

CÓDIGO	P.V.P €
63408499	37,90

RÁCORES 3 VÍAS MIXER

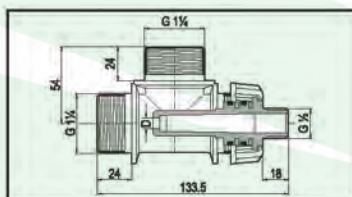

CÓDIGO	mm.	l/mn P	P.V.P €
135 505	5	20 ~ 50	7,00
135 507	7	50 ~ 100	7,00
135 509	9	100 ~ 150	6,10

DISPONIBLE HAST FIN DE EXISTENCIAS



T6
lock coupling

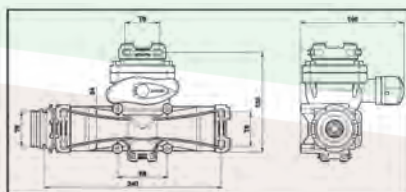

CÓDIGO	Color boquilla	Ø boquilla	P.V.P €
453 M01.001	Black	8 mm.	86,03
453 M01.002	Yellow	11 mm.	
453 M01.004	Grey	5 mm.	

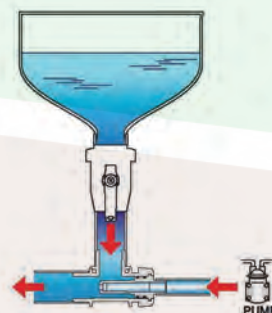

VÁLVULAS UNIDIRECCIONALES / RÁCORES T-6



CÓDIGO	CONEXIÓN	P.V.P €
504 2016	1 1/2 - M	12,03
504 201E	T6	12,03
249 066	T6 - H 1 1/2" M	2,06
010006	HORQUILLA	1,96



MARCADORES ESPUMA



- DELIMITA LA ZONA TRATADA SOBRE EL TERRENO CON UNA BOLA DE ESPUMA INERTE.
- ALIMENTACIÓN ELÉCTRICA (12 Vdc 9A) INDEPENDIENTE DE LA TOMA DE FUERZA. APTO PARA TODAS LAS MÁQUINAS PULVERIZADORAS Y SEMBRADORAS.
- BAJO CONSUMO DE LÍQUIDO ESPUMOSO CONCENTRADO AL 1-2% EN AGUA.
- VÁLVULA DE SEGURIDAD, TUBERIAS (33 M) Y CABLES CONECTORES INCLUIDOS.



ESPUMOGENO CONCENTRADO



KIT CONEXIÓN PARA BRAVO 300S/180S Y CAJAS 4669



KIT FIJACIÓN DEPOSITO -OPCIONAL -

CÓDIGO	DESCRIPCIÓN	P.V.P. €
15. 520 004	MARCADOR ESTÁNDAR PIÑA LARGA 350 mm.	
15.5200051	MARCADOR PIÑA CORTA	710,00
15.520005C	MARCADOR P / ORDENADOR / CAJA 4669	
520005C.100	KIT CONEXIÓN ORDENADOR	100,31
520005.500	KIT FIJACION DEPOSITO	14,85
15.000005	ESPUMOGENO CONCENTRADO GARRAFA 5 KG.	33,00 NETO



- 1 Depósito de líquido espumoso
- 2 Compresor de aire a 12 V cc
- 3 Distribuidor con electroválvulas
- 4 Toma de corriente eléctrica
- 5 Interruptor selector derecha-izquierda
- 6 Mezclador aire/líquido espumoso
- 7 Tubo flexible caída espuma
- 8 Bola de espuma
- 9 Filtro líquido
- 10 Tapón con válvula de seguridad

2022



ELECTROPULVERIZADOR



Quello che mancava

Made in Italy desde 1966



**DUPIGET
PRECISION**

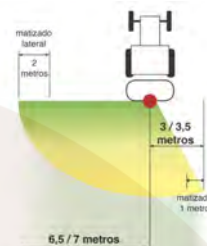
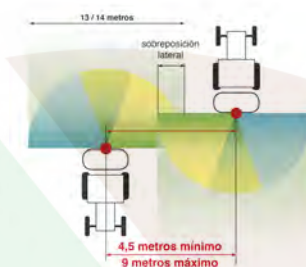
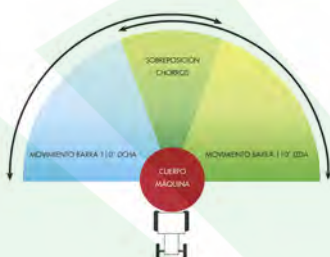

APLICACIONES DE HERBICIDAS, RIEGO Y TRATAMIENTOS ANTIPARASITARIOS

INDICADO DONDE RESULTA IMPOSIBLE O INCOMODO EL TRABAJO CON UNA BARRA CLÁSICA

- * Nuevo movimiento de los gets con ángulo de 110°
- * Óptima uniformidad de distribución
- * Distribucion ancho variable manteniendo la UNIFORMIDAD de distribución
- * A una presión de 10 bar el VDM de las gotas es de 450 µm con total ausencia de gotas inferiores a 200 µm
- * Aconsejada Bomba de mín 20 bar - máx 50 bar con un caudal mínimo de 50 l/mn. No puede funcionar con Bombas de Baja presión

TABLA INDICATIVA DE APLICACION - ANCHO TRABAJO 9 M - PRESION 10 BAR

Ø BOQUILLA	L/mn	C.V.	4 Km/h	5 Km/h	6 Km/h	7 Km/h	8 Km/h
			l/ha	l/ha	l/ha	l/ha	l/ha
2,0+2,0	14	8,3%	230	190	160	130	120
2,5+2,5	19,9	8,1%	330	270	220	190	170

C.V. - Coeficiente de Variación en la uniformidad de distribución. /Según las actuales normas el CV debe estar entre 0% (uniformidad absoluta) y el 10 %

CV Uniformidad de Distribución en base al ancho de trabajo a 5 km/h - boq 2,5x2,5 mm

Ancho trabajo m	4,5	5	5,5	6	7	8
C.V.	2,4%	1,8%	5,3%	6,7%	7,8%	3,5%
L/ha	530	480	430	400	340	300

CÓDIGO	DESCRIPCIÓN	P.V.P. €
13006 00 0011	DUPIGET PRECISION boquillas chorro 2,5+2,5 mm	880,00

En 1966 Ettore Casotti patenta el primer electropulverizador Electroget que permitia trabajar comodamente en presencia de obstáculos.

En los años 80 la evolucion a Euroget y Superget mejoran la uniformidad de distribución con valores de CV entre 5,2% y 4,6% en anchos de trabajo de 9 m.

En el 2016 despues de 50 años de la primera patente, DUPIGET PRECISION con el aval del DISAFA (Turín) - Departamento de Ciencias Agrarias, Forestales y Alimentarias) logra el objetivo de mantener el CV en los parámetros legales aún tabajando a 1 solo lado.



BARRAS INTERFILAS

CARACTERÍSTICAS:

- Tubería en Acero Inoxidable.
- Articulación mecánica salva obstáculos y retorno automático.
- Soporte central que regula la altura y anchura.
- Mecanismo de fijación del ángulo de trabajo y transporte hasta 200° con resorte, de fácil manejo y posicionamiento manual.
- 3 Jets con antigoteo, dos con boquillas Kematal TF 110° y el del extremo exterior con boquilla latón OC de chorro lateral.
- Pantalla de amplia protección antideriva, de plástico termoconformado y faldón contacto.

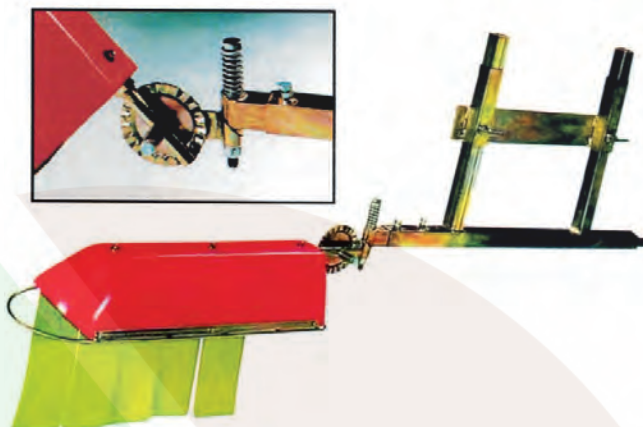

APLICACIONES:

- Adaptación universal parte delantera o trasera del tractor.
- Especial distribución de herbicida, para viña, arbolado, hortalizas, etc.
- Predispuestas para diferentes ángulos.

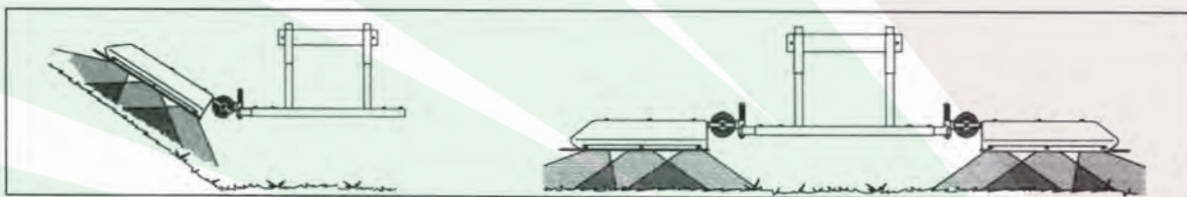

CÓDIGO	DESCRIPCIÓN	P.V.P. €
200 1 08 199 010 00	Barra Interfilas Completa (1 lado) CON SOPORTE	280,00
200 3 08 199 010 00	Kit Soporte Central (Pos. 1 + 2 + 4 + 5) incluido en Barra Completa	50,00
200 1 08 199 011 00	Barra Interfilas (1 lado) SIN SOPORTE	230,00

OTROS COMPONENTES PARA FABRICANTES SOLICITEN INFORMACIÓN

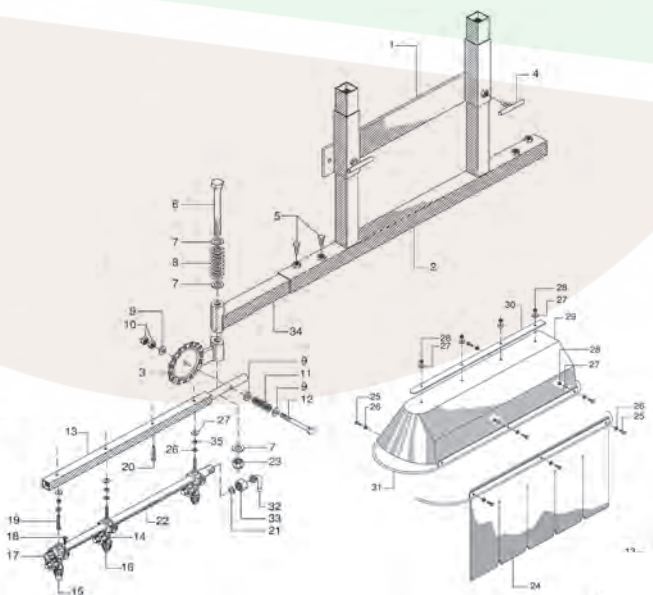



DETERGENTE LIMPIA MÁQUINAS



TAN PLUS VARIANT

ALTAMENTE CONCENTRADO - 5KG

PVP **25,00 €**

DOSIFICACIÓN 2% AL 4%

APLICACIÓN PARA TODO TIPO
DE VEHICULOS MEDIANTE
PULVERIZACIÓN, TUNEL DE LAVADO,
BOX, ETC.

MANTÉN TU MÁQUINA
LIMPIA
COMO EL PRIMER DÍA



2022



**PULVERIZADOR ATV
DE LUXE**



Depósito 98 l compatible con Rounduo con asas ergonómicas

Tapa de 190 mm

Bomba 12 V - 8,3 l - 4,8 bar Serie 2.2 - LONG FIFE

Válvula de regulación con manómetro



Depósito polietileno especial resistencia química y a los rayos UV

Filtro de fácil acceso

Lanza-pistola con boquilla regulable y 4,6 m manguera

902 x 457 x 381 mm - 11,3 kgs

CAPACIDAD DEPÓSITO 98 lts

COD	DESCRIPCION	P.V.P. €
25056 +		
999 06 DLX	KIT PULVERIZADOR DE LUXE - 98 l - BOMBA 12V - 8,3 l/mn - 4,8 bar	435,00
000 99 900	KIT BARRA 2 BOQUILLAS P/ ATV DE LUXE	150,00



ACCIONAMIENTO CONTROL SELECTIVO BOQUILLA DERECHA



PULVERIZADOR ATV



SIMPLE - ROBUSTO - ALTAS PRESTACIONES

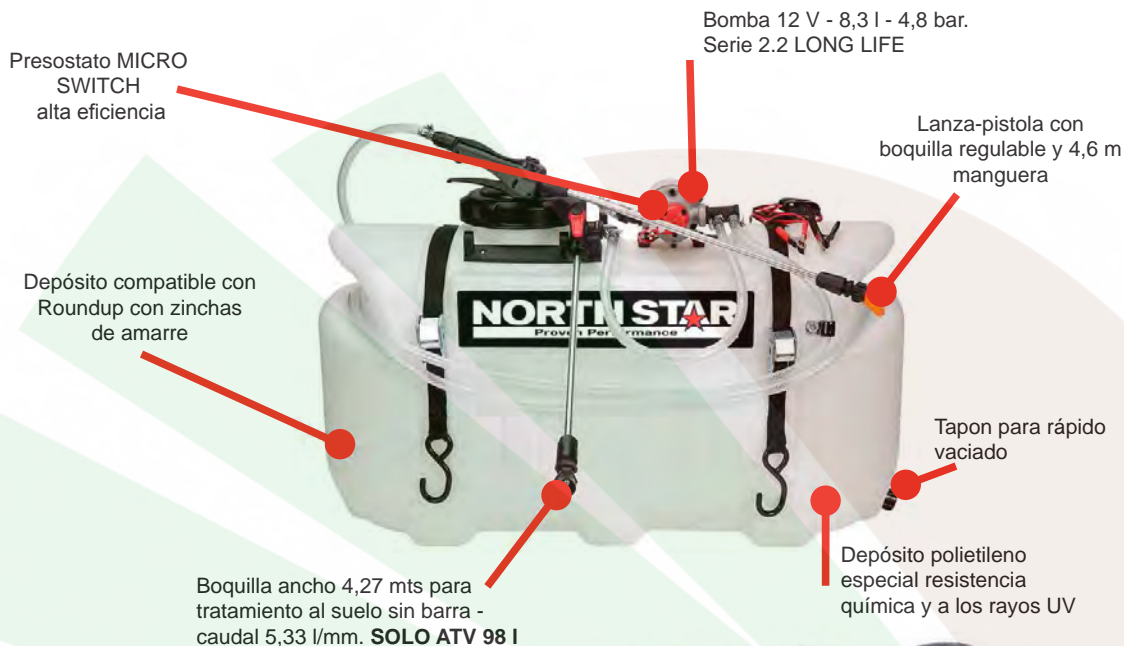

**864 X 368 X H521 mm - 10 kgs.
CAPACIDAD DEPÓSITO 98 lts.**



2022

COD 25056 +	DESCRIPCION	P.V.P. €
268 121 01	KIT PULVERIZADOR ATV 98 L - BOMBA 12V - 8,3 l/mn - 4,8 bar	290,00
268 100 11	KIT PULVERIZADOR ATV 60 L - BOMBA 12V - 8,3 l/mn - 4,8 bar	210,00
009 990 0X	KIT BARRA 2 BOQUILLAS P/ATV ESTÁNDAR C/ VÁLVULA	150,00



KIT BARRA 2 BOQUILLAS
INCLUYE VÁLVULA REGULACIÓN



864 x 368 x H419 mm - 8,2 kgs
CAPACIDAD DEPÓSITO 60 lts



ANEMOMETRO - POCKETWIND

Digital alta fiabilidad - Robusto - Fácil manejo



Pocketwind IV

Humedad relativa / Velocidad y dirección aire ambiente.
(Rango medicion 0-38 km/h -0-10,6 m/s) / Temperatura

18025. POCKIV

135 € NETO



PROBETA 2000 ml.

Divisiones 20 ml conforme ISO/DIS 16119 de cristal transparente

6124418

SIN certificado

60,00 € NETO

6124316

CON certificado

100,00 € NETO

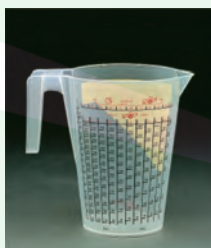

JARRA "QUICK-CHECK"

- JARRA PARA COMPROBACIÓN DEL CAUDAL EN l/min.
- CONTIENE ABACO P/RAPIDO CONTROL DE DOSIS EN l/ha.

925 101

13,42 €



PAPEL HIDROSENSIBLE AL AGUA

- UTILIZADOS COMO TESTIGO PARA EVALUACION DE LAS CARACTERISTICAS DE PULVERIZACION:
- DISTRIBUCION - COBERTURA - TAMAÑO GOTAS - ETC...

429 050

50 uds

76 mm x 26 mm

50,92 €

429 051

50 uds

76 mm x 52 mm

82,75€



LLAVE TUBULAR BAYONETA

FACILITA EL MONTAJE/DESMONTAJE DE LOS CABEZALES DE ATAQUE RÁPIDO A BAYONETA.
PERMITE SU MANIPULACION SIN RIESGO DE LESIONES EN LOS DEDOS Y EVITANDO EL CONTACTO DIRECTO CON PRODUCTOS QUIMICOS

P00004911

ESTÁNDAR

28,60 €

ESTANDAR VÁLIDO PARA PORTABOQUILLAS ARAG-LECHLER-TEEJET - GLINE



CEPILLO P/ LIMPIEZA BOQUILLAS

429 100

5,00 €



TESTPUMP LPP40

Bomba comprobadora Manómetros



NO incluido



*BOMBA MANUAL para test - **Manómetros - Sensores presión electrónicos y Vacuómetros**

*NO UTILIZA FLUIDOS

*Válida para Test de 0 – 40 bar

*Precisión 0,95 bar

*MANOMETRO COMPROBACION NO INCLUIDO (Conexión ½ “)

FLPP40

710,00 € NETO

MANOMETROS DE COMPROBACION INOX
CL. 0,5- ESFERA Ø 100 – ½ “ m (EN 837-1)



CÓDIGO	ESCALA bar	P.V.P. NETO €
5121400	0...6	137,30
5121500	0.....10	137,30
5121700	0.....25	137,30
5121800	0.....40	137,30
6301000	CERTIFICADO CALIBRACION FÁBRICA	31,80
9302000	CERTIFICADO CALIBRACION EXTERNO	247,20

MALETIN TRANSPORTE APILABLE / COMBINABLE

ECOBX

105,00 € NETO



FLOWRATE ECO

MEDIDOR DIGITAL CAUDAL BOQUILLAS



- * Preciso sensor de caudal de 0,40 a 7 l/mn
- * Adaptador para medida individual de cada boquilla.
- * Display informacion acumulada para 100 boquillas – LECTURA CON 2 DECIMALES
- * Bateria 12 V – recargable-

FLOWRATE ECO 1.750,00 € NETO

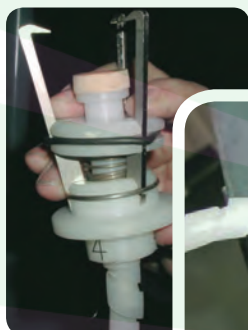

CABEZAL ANCLAJE UNIVERSAL
RÁPIDA CONEXIÓN
CON 3 mts DE TUBO.

1SPECIAL ADAP 150,00 € NETO



MALETIN TRANSPORTE
APILABLE/COMBINABLE

ECOBX 105,00 € NETO



HERBST - ALEMANIA



40 años de experiencia en el control y medición de la pulverización. Dispositivos homologados y certificados



MONITORES E INSTRUMENTACION CONTROL PRESIÓN

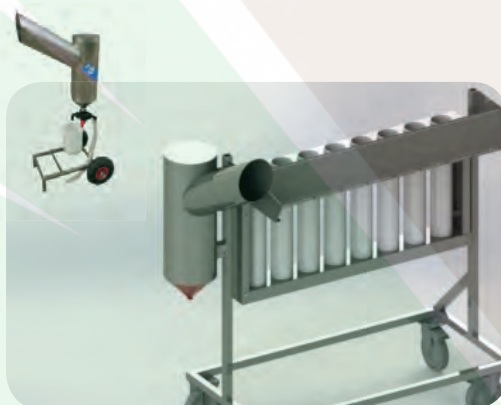

BANCOS DE CALIBRACION CAUDAL Y ANEMOMÉTRICOS

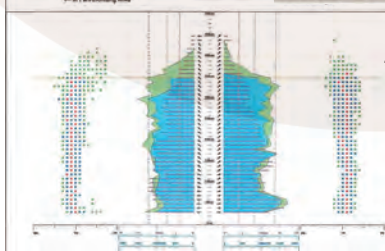
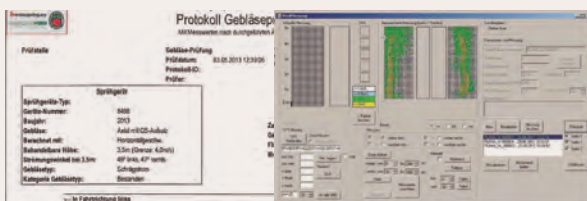

***TRANSMISION DATOS A PC POR CABLE Y W-LAN**
***SOFTWARE DE ANALISIS E INFORMES SEGÚN PROTOCOLO CERTIFICACIONES**

FG.FIORENTIN - ITALIA



2022

SOLICITE INFORMACION DETALLADA



ACCESORIOS

TUERCAS ATAQUE RÁPIDO



CPH HC01	1,10 €	40290403	0,56 €	40290901	0,56 €	40291001	1,12 €
ADAPTABLE A PORTABOQUILLAS HARDI P/LATIGUILLO		BAYONETA ESTÁNDAR P/ LATIGUILLO		BAYONETA ESTÁNDAR CIEGA (TAPON)		BAYONETA ESTANDAR ROSCA 1/4 " H	

ACOPLES ROSCADOS/BAYONETA



400270 MACHO 1/4	0,80 €	400275N HEMBRA 1/4	1,19 €	400276 HEMBRA 3/8"	1,70 €	400279 H 1/2	1,41 €
				400277 H 1/2	1,70 €	400280 H 3/4	1,51 €
				400278 H 3/4	1,91 €		

ACOPLES BAYONETA



92163560	5,90 €	40291401	1,60 €	40291601	2,25 €	506152500	0 - 5 - 25
ADAPTADOR PORTABOQUILLAS HARDI A BAYONETA ESTÁNDAR						506156000	0 - 20 - 60
							P.V.P. 46,00 €

RACOR ACOPLE A TUERCAS ATAQUE RÁPIDO



105108 - D 8	0,47 €
105110 - D 10	

MANOMETROS ESTÁNDAR E ISOMÉTRICOS CI 1.6 CAJA INOX ESFERA 63 - ROSCA 1/4 " VERTICAL

106101000	0-10
106101600	0-16
106102500	0-25
106104000	0-40
106106000	0-60

P.V.P. 9,20 €



EJEMPLOS DE MONTAJE



2022





BOMBA CENTRÍFUGA MULTITETAPAS

MSP400

Primera Bomba ARAG multietapas especialmente diseñada para pulverización agrícola.

Sistema de múltiples impulsores desarrollados con tecnopolímeros de alta resistencia y excelente compatibilidad con productos químicos.

Cuidadoso diseño con elevadas prestaciones a reducidas RPM y precio competitivo.



- * Alto rendimiento (bajo caudal de aceite).
- * Tamaño compacto - Peso 9,5 Kg.
- * **Caudal 400 l/mn a 8 bar (4200 RPM)**
- * Conexiones de salida independientes de la posición de fijación.

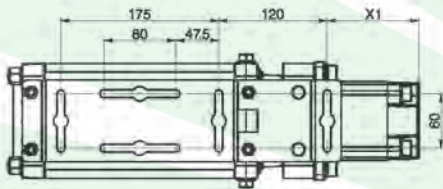

Motor			
	7.2 cm ³ /rev.	11.2 cm ³ /rev.	14.5 cm ³ /rev.
X1 (mm)	111	116	121



Con motor hidráulico

CÓDIGO	CONEXIÓN					D	P.V.P. €
A	IN-T7 OUT - T6"	MAX caudal agua	MAX presión agua	MAX caudal aceite	MAX presión aceite	Motor	
Horquilla		l/min	BAR	l/min	BAR		
970 05221		517	7.5	26.5	135	7.2	1.270,00
970 05201		560	10.6	49.2	120	11.2	
970 05231		567	11.0	64.3	106	14.5	

Disponible MSP800-960l/m. Consulten características

KIT SENSOR RPM 12 Vdc

Cable 20 cm.
Señal salida NPN



CÓDIGO	P.V.P. €
970 000.500	50,40

KIT VALVULA ANTI RETORMO

A instalar en el conducto de descarga del motor hidráulico. Protege el motor caso de conexión incorrecta. Conexión 3/4 "



CÓDIGO	P.V.P. €
970 001	23,34

2022



BOMBAS CENTRIFUGAS



BOMBA CENTRÍFUGA AUTOASPIRANTE (NO auto-cebante) PARA USO EN EQUIPOS DE ABONADO, HERBICIDAS, ATOMIZADORES Y APLICACIONES DE RIEGO.

GRAN CAUDAL PARA LLENADO, MEZCLA, TRASVASE, A MAX. 2 BAR.

PERMITE EL PASO CON AGUAS SUCIAS, SALADAS Y CON PRODUCTOS QUIMICOS AGRESIVOS Y ABONOS.

FABRICADA CON MATERIAL PLÁSTICO DE ALTA RESISTENCIA, TURBINA 5 PALAS, JUNTAS EN EPDM Y PARTES EN INOX.

ROSCAS IN/OUT – 2" NPT HEMBRA - MÁX. 650 L/MN - 3600 RPM-



Cámara intermedia sello húmedo

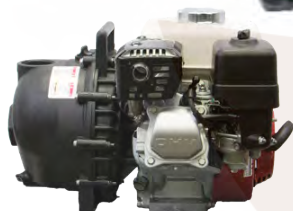

CÓDIGO	DESCRIPCIÓN	P.V.P. €
200PHY	c/ MOTOR HIDRAULICO	1.140,00
200PHYW	c/ MOTOR HIDRAULICO SELLO HUMEDO	1.610,00
205 PB	EJE LIBRE 3/4" CON PIE	597,00
200 PH5	MONOBLOC c/MOTOR GASOLINA ORIGINAL HONDA 5,5 cv	1.575,00
230 PPEE5	MONOBLOC c/ MOTOR ELECTRICO EU 5,5 CV TRIFÁSICO	1.330,00

TABLA RENDIMIENTOS A 3450 RPM - 200PHY

Longitud (m)	0	3	7	10	14	17	21	24	28	31
Presion (bar)	0	0,35	0,69	1,04	1,38	1,73	2,07	2,42	2,76	3,11
Caudal (l/mn)	738	681	644	587	549	473	416	322	227	76



BOMBAS DE MEMBRANA 12 V Y 24V



- *MEMBRANAS DE SANTOPRENE (resistencia química similar DESMOPAN)
- *VÁLVULAS VITON
- *CUERPO EN PP
- *AUTOASPIRANTE HASTA 1 - 1,5 MTS SEGÚN MODELOS
- *VERSIONES RACOR RÁPIDO -5D- QC Y ROSCA 1/2" NPT
- *MOTOR GRAN CALIDAD APTO PARA TRABAJO EN CONTINUO
- *PROTEGIDAS CON PRESOSTATO HONEYWELL CON CONTACTOS DE PLATA.

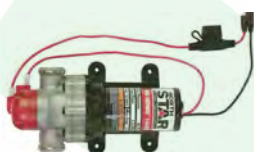

SERIE 1.0 -
3,8 lpm



SERIE 4.0 - 15,1 lpm



SERIE 5.5 - 20,8 lpm



SERIE 2.2 -
8,3 lpm



SERIE 3.0 -
11,4 lpm

NUEVO MODELO



SERIE 7.0 - 26,5 lpm

25056				PRESIÓN MAX	P.V.P €	medidas mm
CODIGO	CAUDAL l/mn	conexión	SERIE	bar	IVA Y PORTES, APARTE	peso kg
268 1042	3,8	QC	1.0	2,7	64,00	184x88x78 (0,9)
268 2272	8,3	QC	2.2	4,8	110,00	230x102x102 (1,8)
268 3061	11,4	H 1/2"	3.0	4,1	115,00	230x140x127 (2,7)
268 3062	11,4	QC	3.0	4,1	115,00	
268 4061	15,1	H 1/2"	4.0	4,1	145,00	
268 4062	15,1	QC	4.0	4,1	145,00	
268 5561	20,8	H 1/2"	5.5	4,1	175,00	230x140x127 (2,7)
24V-268 5563	20,8	H 1/2"	5.5	4,1	175,00	
268 5562	20,8	QC	5.5	4,1	175,00	
268 7061	26,5	H 1/2"	7.0	4,1	325,00	233 x143x139 (4,3)
24V-268 7063	26,5	H 1/2"	7.0	4,1	325,00	
268 7062	26,5	QC	7.0	4,1	325,00	

QC- RACOR RÁPIDO 5D - INCLUIDOS EN BOMBAS QC

NUEVA CONEXIÓN: H 1/2- ROSCA HEMBRA 1/2 NPT

INFORMACION ADICIONAL: WWW.NTEINTERNATIONAL.COM

2022



BOMBAS DE MEMBRANA 12 V ALTA PRESION



INCORPORAN INNOVATIVOS COMPONENTES PARA TRABAJO ALTA PRESION Y EN CONTINUO SIN REQUERIR PERIODOS DE ENFRIAMIENTO.

CODIGO 25056	CAUDAL l/mn	RACORES RAPIDOS 5D INCLUIDOS	SERIE	bar	P.V.P €	medidas mm - peso kg
268 14102	5,7		1.5	6,9	10,3	155,00
268 15152						

BOMBA DE PISTON 12 V - ALTA PRESIÓN

Nueva serie de Alta Presión y elevado rendimiento. Adecuada para aplicaciones en las que se requiere mayor alcance de la pulverización con pistola y/o alta micronización. Equipada con válvula de regulación, Manómetro y racorería de entrada y salida.

SERIE 2.0 - AP - máx. 13,8 BAR - máx. 7,6 lpm

- * Pistón revestimiento cerámico con collarín.
- * On-Demand - paro automático al cerrar la salida de Bomba
- * Fusible protección motor
- * Incluye Válvula de regulación y manómetro con tomas de salida para distintos servicios.



CODIGO 25056	CAUDAL l/mn	Conexión	SERIE	bar	P.V.P €	medidas mm - peso kg
268 20200	7,6	QC	2.0	13,8	475,00	226x193x164 (5,9)

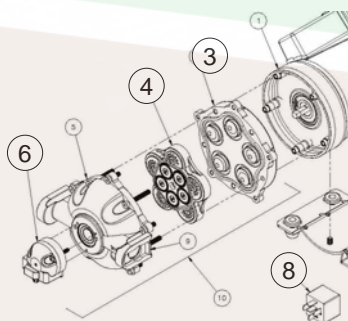

“RECAMBIOS BOMBAS MEMBRANA 12 V”

	POS. 3		POS. 4		POS 6		POS 8	
SERIE	KIT MEMBRANAS	PVP	KIT VÁLVULAS	PVP	PRESOSTATO	PVP	RELE	PVP
1.0	790576	11,00	790584	5,00	791635	12,00		
2.2	794988	18,00	794989	9,00	786953	13,00		
3.0	788017	36,00	788015	19,00	788689	14,00		
4.0	788018	36,00						
5.5	788019	35,00						
7.0	788019	35,00						
1,5 AP	797013	27,00	-	-	-	-	788929	17

INFORMACION ADICIONAL: WWW.NTEINTERNATIONAL.COM



BOMBAS 12 V - APLICACIONES ESPECIALES -



BOMBA 2 MEMBRANAS KAPPA 15 - 12 V

- *Monobloc robusto con Motor de imanes permanentes tipo GR71 B3/B14 - 220 W - 26 Amp
- *Adecuada para aplicaciones en las que se requiere máxima fiabilidad en trabajo continuo con Bomba de mecánica tradicional y elevado rendimiento.
- *Equipada con válvula de regulación integrada y rácores de entrada Ø 20 y salida ø 8.



KAPPA 15 /12 Vdc - Max. 4 bar - 16 lpm

- * 2 Membranas desmopan y calderin de aire.
- *Sistema mecánico cigüeñal/bielas/pistón en carter con baño de aceite
- *Válvulas aspiracion/impulsion de muelle y asiento Inox.

CODIGO	MAX CAUDAL l/mn	conexión mm	SERIE	bar	P.V.P €	peso kg
04022						
448 400	15	in Ø20 - out ø 8	k-15	4	525,00	10

BOMBA CENTRÍFUGA 12 V TRASVASE



- *CABEZAL INOX - CONEXIÓN 3/4 " NPT
 - *Max l/mn - 72 - Max bar 0,62
- Tabla rendimiento

BAR	0,14	0,21	0,28	0,34	0,41	0,48
l/mn	62	53	47	28	25	10

CODIGO	MAX CAUDAL l/mn	conexión	SERIE	bar	P.V.P €	medidas mm - peso kg
25048						
9700S	72	3/4"NPT		0,62	470,00	178 X 101 (2,7)

2022



ACCESORIOS BOMBAS 12 V



25056

CÓDIGO	DESCRIPCIÓN	P.V.P. €
268 1032	KIT VALVULA REGULADORA QC, Máx. 6,9 bar, Incluye MANOMETRO Ø 63 mm, RACORES, SOPORTE Y RACOR MEZCLADO	43,00

09003. VALVULA REGULADORA - Max 20 l/mn - SALIDA "F" 1/2" M - RETORNO "D" Ø 13 mm - SIN MANOMETRO

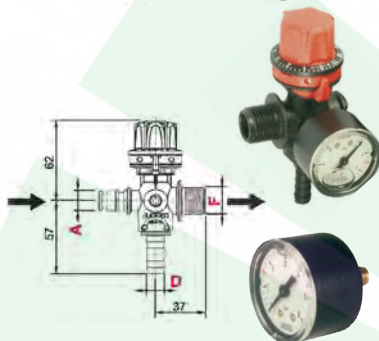

CÓDIGO	DESCRIPCIÓN	P.V.P. €
962 0522	A entrada QC (5D)	16,02
962 0122	A entrada 3/8 M	
962 0222	A entrada 1/2" M	
962 0922	A entrada Tuerca loca 1/2" H	9,50
908 006	Manometro 0-6 bar Ø 40 mm Rosca trasera 1/8"	

MINI FILTRO ASPIRACION ENTRADA "D" Ø 13 mm

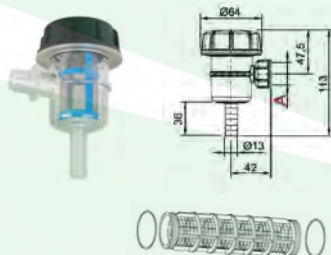

CÓDIGO	DESCRIPCIÓN	P.V.P. €
309 T253	A CONEXIÓN 1/2 " M	5,85
309 TB53	A CONEXIÓN QC (5D)	5,41
309 T953	A CONEXIÓN 1/2 H	5,85
324 2003 030	Cartucho 27 x 69 - 50 Mesh	3,89
324 2004 030	Cartucho 27 x 69 - 100 Mesh	3,89

CÓDIGO	DESCRIPCIÓN	P.V.P. €
4668 5101M	CAJA DE MANDO 1 INTERRUPTOR Cable alimentacion 2 m. Cable conexión 4 m	68,00
777 493	PINZAS C/CABLE-INTERRUPTOR conexión BATERIA	13,00



CÓDIGO	DESCRIPCIÓN	P.V.P. €
F175DFA38-787 208	RACORD RECTO QC D.10mm	2,90
F175DFA12-787 209	RACORD RECTO QC D.13mm	2,90
787 210	RACORD RECTO QC D.19mm	2,90
962 5202 - 787 211	UNION MACHO QC 1/2" NPT	1,70
F175DFE38-787 212	RACORD CODO QC D.10mm	3,20
F175DFE12-787 213	RACORD CODO QC D.13mm	3,20
787 214	RACORD CODO QC D.19mm	3,25
787 215	RACOR 50º CODO QC D.13mm	3,25
787 216	RACOR CODO QC D.10mm + H1/4" NPT	4,50

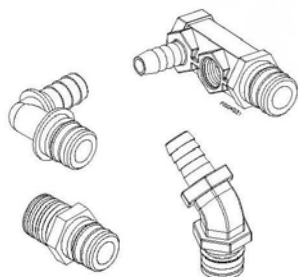

2022



BOMBAS DE MEMBRANA 12 V



FRESH WATER NUEVA SERIE AGUA DULCE/POTABLE

APLICACIONES SECTORES: CAMPER - CARAVANAS - CAMPING - NAUTICO - RIEGOS - DOMESTICO ETC.
 FUNCIONAMIENTO SILENCIOSO Y EFICIENTE, PARO AUTOMÁTICO, AUTO-CEBADO HASTA 1,8 m. SIN DAÑOS POR FUNCIONAMIENTO EN SECO.

DERIVACIÓN INTERNA DE ENCENDIDO/APAGADO QUE PROPORCIONA UN FLUJO ESTABLE NO PULSANTE AÚN EN BAJO CONSUMO.

MOTOR TÉRMICAMENTE PROTEGIDO - MEMBRANAS DE SANTOPRENE - VÁLVULAS EN EPDM - MUELLE VÁLVULAS INOX - COMPONENTES PLÁSTICOS PP Y NYLON.

“CERTIFICADOS: CSA (Canada) NSF (USA) y CE.



CÓDIGO	DESCRIPCIÓN	P.V.P. €
157103	NorthStar 3055R 11.4L - máx. 3,8 bar (incluidos 2 rácores y Filtro con tuercas) Peso 2,5 Kg	120,00
157104	NorthStar 5055R 18.9L - máx 3,8 bar (incluidos 2 rácores y Filtro con tuercas) Peso 2,72 Kg.	155,00

SOFT WASH NUEVA SERIE ACIDS" ESPECIAL DESINFECCIÓN



APLICACIONES EN LIMPIEZA Y DESINFECCION A BAJA PRESIÓN CON LEJÍA PARA ELIMINACION DE LÍQUENES, MOHO Y SUCIEDAD EN TECHOS, REVISTIMIENTOS, FACHADAS... SIN DAÑAR CON ALTA PRESIÓN, RASPADORES O CEPILLOS.

EXCLUSIVO MOTOR ESTANCO CON PARO POR DETECCIÓN DE FUGAS.

FUNCIONAMIENTO EN CONTÍNUO SIN REQUERIR PERIODO DE ENFRIAMIENTO - AUTO-CEBADO CAPAZ DE FUNCIONAMIENTO EN SECO - PARO AUTOMATICO CON PRESOSTATO.

CABEZAL MONOBLOC DE FÁCIL SUSTITUCIÓN

CÓDIGO	DESCRIPCIÓN	P.V.P. €
157145	NorthStar 8.3 LPM 12V QC - 4,8 bar	140,00
157147	NorthStar 15.1 LPM 12V QC - 4,1 bar	185,00
157153	NorthStar 20.8 LPM (5.5 GPM) 12V QC - 4,1 bar	195,00



BOMBAS PISTÓN CERAMICA



AB SERIES



T-44



T-33



CÓDIGO	MODELO	PISTONES	CAUDAL l/mn	PRESIÓN Bar	CIGUEÑAL	P.V.P. € (sin accesorios)
01002 AB0150CC	AB 150	3	150	60	ESTRIADO / ESTRIADO	1.900,00
01002 AB0120CC	AB 120		120			1.520,00
01002 AB0080CC	AB 80		75			1.380,00
01002 AB0080LD	AB 80	3	75	60	CILINDRICO	1.500,00
01 002 00441	T-44-C	3	42	40	ESTRIADO / CILINDRICO	830,00

BOMBAS PISTÓN EMBOLO

CÓDIGO	MODELO	PISTONES	CAUDAL l/mn	PRESIÓN Bar	CIGUEÑAL	P.V.P. € (sin accesorios)
01 002 00444	T-50-E	3	50	55	ESTRIADO / CILINDRICO	740,00

BOMBAS PISTÓN CERAMICA



CÓDIGO	MODELO	PISTONES	CAUDAL l/mn	PRESIÓN Bar	CIGUEÑAL	P.V.P. € (sin accesorios)
01 022 837700	GAMMA-62	3	62	50	ESTRIADO /CILINDRICO	855,00
01 022 837600					ESTRIADO / ESTRIADO	
01 022 838200	GAMMA-85	3	78	60	ESTRIADO /CILINDRICO	1.240,00
01 022 838700	GAMMA-105	3	100	60	ESTRIADO /CILINDRICO	1.260,00
01 022 838600	GAMMA-105		100		ESTRIADO/ ESTRIADO	1.260,00
01 022 839100	GAMMA-125		124		ESTRIADO/ ESTRIADO	1.290,00
01 002 840100	GAMMA-242	6	238	60	ESTRIADO/ ESTRIADO	2.400,00



G-62



G-85 - G-105 - G-125



G-242



**BOMBAS MEMBRANA
BAJA PRESIÓN
HERBICIDAS - máx. 20 bar.**



Z85



Z100



Z260

CÓDIGO 04 022	MODELO	MEMBRANAS	CAUDAL l/mn	CIGUEÑAL	P.V.P. €
845 100	ZETA-70-1C	3	70	1 C	395,00
976 300	ZETA-85-1C	3	85		445,00
976 400	ZETA-100-1C	3	98		490,00
846 800	ZETA-120-1C	3	116	1 C	630,00
846 900	ZETA-140-1C	3	135		665,00
845 500	ZETA-140-TS-1C	3	135	TS - 1C	697,00
846 700	ZETA-170-TS-2C	4	170	TS 2C	995,00
849 700	ZETA-200-TS-2C	4	198		1.160,00
849 800	ZETA-260-TS-2C	6	256		1.290,00
849 600	ZETA-300-TS-2C	6	295		1.530,00



**CONSULTAR OTRAS VERSIONES
DE EJES SALIDA**

TS 2C - ESTRIADO / ESTRIADO 1C - ESTRIADO 1 LADO TS 1C - CILÍNDRICO Ø 25 / ESTRIADO

ESPECIAL SERIE CON CABEZAL DE POLIESTER



ZP 100

CÓDIGO	MODELO	l / mn	P.V.P. €
828 200	Z P 100 - 1C	98	545,00
829 400	Z P 85 - 1C	85	495,00

ALTA RESISTENCIA QUÍMICA



ACOPLAMIENTOS PARA MOTORES HIDRÁULICOS

MOTORES NO INCLUIDOS

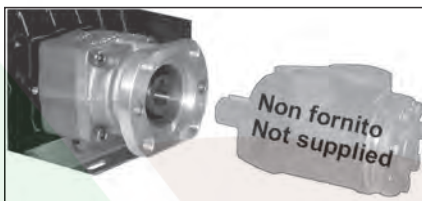

MODELO	VERSION CIGÜEÑAL								CÓDIGO	P.V.P. €	motor tipo DANFOSS
	VA	GR	TS VA	TS GR	1C	TS 1C	TS 2C	TS FVA			
ZETA 85					✓	✓			418700	145,00	OMP80/OMR50
ZETA 300								✓			OMR 100
ZETA 260								✓			OMR 80
ZETA 230								✓	417300		
ZETA 200					✓	✓					
ZETA 170					✓	✓					
ZETA 140					✓	✓					
ZETA 120					✓	✓			418700		OMP80/OMR50
ZETA 100					✓	✓					
RO 400								✓	417100		OMS 125
RO 320								✓			
KAPPA 65	✓							✓	419600	87,00	OMP 50/OMR 50
KAPPA 55	✓							✓			OMR 50
KAPPA 53		✓							417700	OMP 50/OMR 50	
KAPPA 50	✓							✓	420300	OMP 50	
KAPPA 43		✓							417700	OMP 40	
KAPPA 40	✓							✓	420300		
KAPPA 33		✓							417700		
KAPPA 32		✓		✓					420100		
KAPPA 25		✓		✓							
GAMMA 85						✓	✓		416700	145,00	OMP 80
GAMMA 62				✓		✓	✓				OMR 80
GAMMA 105						✓	✓				
DELTA 75	✓		✓						415400	93,00	OMP80/OMR50
DELTA 100	✓		✓								
	VA	GR	TS VA	TS GR	1C	TS 1C	TS 2C	TS FVA			

417100 – Acoplamiento para cigüeñal motor cilindrico Ø 32 brida 4 agujeros

417200 + 419800 – Acoplamiento para cigüeñal motor cilindrico Ø 40 brida 4 agujeros

Resto acoplamientos para cigüeñal motor cilindrico Ø 25 brida SAE "A" 2 agujeros

Algunos tipos disponibles tambien para cigüeñal motor Ø 1" SAE "A" 2 agujeros- consulten



**BOMBAS MEMBRANA
MEDIA PRESIÓN**

3 membranas - máx. 40 bar



KAPPA 33-43-53



KAPPA 55-65



1C



TS 1C

CÓDIGO	MODELO	MEMBRANAS	CAUDAL l/mn	PRESIÓN Bar	CIGUEÑAL	P.V.P. €
040223303000	KAPPA-33	3	33	40 bar	1 ESTRIADO 1C	400,00
040224301000	KAPPA-43	3	46			410,00
040225301000	KAPPA-53	3	55			445,00
040225502000	KAPPA-55	3	57	40 bar	ESTRIADO CILINDRICO TS 1C	515,00
040226502000	KAPPA-65	3	67			530,00

**BOMBAS BASE CON RACORES ASPIRACIÓN
VÁLVULA REGULACIÓN NO INCLUIDA**



CÓDIGO	MODELO	P.V.P. €
09022601093	VALVULA DL2/40 - CON 2 GRIFOS + MANOMETRO	90,00

CONJUNTO BOMBA CON POLEA 2 A Ø 320 MM Y VÁLVULA DS

CÓDIGO	MODELO	MEMBRANAS	CAUDAL l/mn	PRESIÓN Bar	P.V.P. €
040224303100	KAPPA-43 GR	3	46	40	565,00
040225303100	KAPPA-53 GR	3	55		600,00



POLEA "2A"



**CONSULTAR OTRAS
VERSIONES CIGÜEÑAL
Y ACOPLES**



**BOMBAS MEMBRANA
MEDIA Y ALTA PRESIÓN**



DELTA 75



DELTA 100



KAPPA 121-151

CÓDIGO 04 022...	MODELO	MEMBRANAS	 CAUDAL l/mn	PRESIÓN Bar	EJE	P.V.P. €
813 400	DELTA 75	3	79	40	TS 2C	670,00
806 800	DELTA 100	4	104	40	TS 2C	750,00
808 200	DELTA 125	5	125	40	TS 2C	930,00
821 300	DELTA 140	4	138	50	TS 2C	985,00

RACORES DE ASPIRACIÓN Y PIES SOPORTE, INCLUIDOS

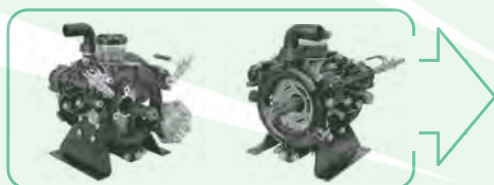

TS - 2 C
ESTRIADO / ESTRIADO

BOMBAS MEMBRANA ALTA PRESIÓN - 50 BAR



OMEGA 139



OMEGA 170



BETA 150

CÓDIGO 04 022...	MODELO	MEMBRANAS	 CAUDAL l/mn	EJE	P.V.P. €
840 500	OMEGA 139	3	137	TS 2C	1.100,00
844 900	OMEGA 170	4	177	TS 2C	1.400,00
977 700	BETA 150	4	170	TS 2C	1.850,00

RACORES DE ASPIRACIÓN Y PIES SOPORTE, INCLUIDOS



VÁLVULAS LIMITADORAS DE PRESIÓN

*Protegen los circuitos hidráulicos de los equipos pulverizadores de acuerdo a la normativa UNI EN ISO 4254-6-2010 que prevé la no superación del 20 % de la presión nominal y el retorno a depósito del eventual líquido en descarga.

*Rearme automático interrumpiendo momentáneamente el paso de líquido y/o bajando a la presión nominal.
*Estructura reforzada.
*Sello anti-manipulación.

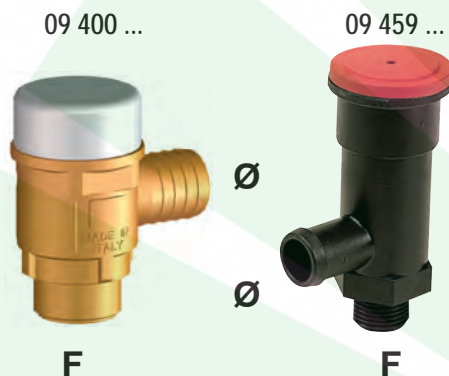

CÓDIGO	PRESION bar	l/mn	Ø	F mm	P.V.P. €
09 459 110	10	100	13	3/8"	12,99
09 459 120	20				
09 459 130	30				
09 459 140	40				
09 459 150	50	200	19	1/2"	12,99
09 459 210	10				
09 459 220	20				
09 459 240	40				
09 459 250	50	250	25	3/4"	12,99
09 459 310	10				
09 459 320	20				
09 400 19071	20	150	20	3/4"	17,60
09 400 19072	30	150	20	1/2"	22,18
09 400 19074	40	200	20	1/2"	22,18

PROTECCIONES T.D.F. PARA BOMBAS PISTÓN Y MEMBRANA



CÓDIGO	DESCRIPCIÓN	P.V.P. €
606605	UNIIVERSAL REFORZADO	12,40
606602	ESPECIAL ZETA 70 - 85 - 100 - 120 - 140 KAPPA 121/151/125	11,00
121948	PROTECTOR TOTAL	7,30
900 001	PORTADOCUMENTOS CILINDRICO TAPA ROSCADA CON ANCLAJES INTEGRADOS EN EL CUERPO	22,29



2022

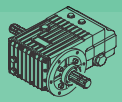

GRUPOS MOTOR BOMBA ELÉCTRICOS

CÓDIGO	MODELO	 PISTONES	 MEMBRANAS	l / min.	PRES. bar	MOTOR	P.V.P. € (sin accesorios)
02022 1501	EGK-15-M		2	15	20	0,8 CV - MONO.	460,00
02022 4310	EGK-43-M		3	45	40	5,5 CV - TRIF.	1.300,00
02022 5310	EGK-53-M		3	55	40	5,5 CV - TRIF.	1.340,00

VÁLVULA REGULADORA INCLUIDA, SIN GRIFOS NI MANÓMETRO

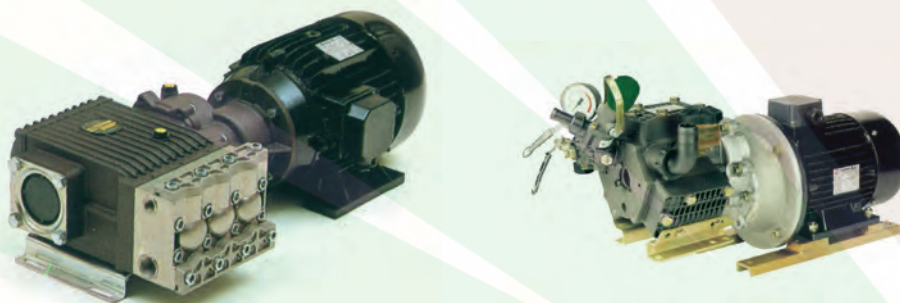

BOMBAS CON REDUCTORA

CÓDIGO	MODELO	P.V.P. € (sin accesorios)
10022 1500	K-15-R HELICOIDAL	265,00

VÁLVULA REGULADORA INCLUIDA, SIN GRIFOS NI MANÓMETRO



DISPONEMOS DE OTRAS APLICACIONES CON MOTORES DE EXPLOSIÓN, HIDRÁULICOS, ETC

SOLICITEN INFORMACIÓN



LANZAS Y PISTOLAS PULVERIZACIÓN

*ALTO RENDIMIENTO PARA TRATAMIENTOS AGRÍCOLAS .

*APERTURA, CIERRE Y DISPOSITIVO DE REGULACIÓN CHORRO, CON UNA SOLA MANO

*EMPUÑADURA ERGONÓMICA – **HYDRA ESPECIAL ZURDOS**

*DIFUSOR AJUSTABLE CON MEZCLA DE AIRE PARA UNA PERFECTA MICRONEBULIZACIÓN (500 GOTAS/CC2 A 5 KM /H)

*TUBO Y PARTES INTERNAS DE ACERO INOX

*BOQUILLA DE CERÁMICA Ø 1,5

***RACORD ENTRADA GIRATORIO 1/2"**

*PRESIÓN MÁXIMA DE TRABAJO 50 BAR



CÓDIGO	DESCRIPCIÓN	P.V.P €
12.00.269.014	Lanza / Pistola "TURBO-400 METAL" Empuñadura metálica con protector. Peso 840 g.	70,00



CÓDIGO	DESCRIPCIÓN	P.V.P €
12.26.901.165	Lanza / Pistola "TURBO-500 STÁNDAR" Empuñadura ligera reforzada. Peso 690 g.	60,00



CÓDIGO	DESCRIPCIÓN	P.V.P €
12.50.624.00C	Lanza / Pistola "HYDRA" Empuñadura ergonómica Dispositivo regulador chorro reversible para zurdos. Peso 530 g.	56,27

ACCESORIOS



CÓDIGO	DESCRIPCIÓN	P.V.P €
23.1903.11	EMPUÑADURA METALICA IN-OUT 1/2"H	29,30
29.1903.9	EMPUÑADURA ESTÁNDAR IN-OUT 1/2"H	17,10

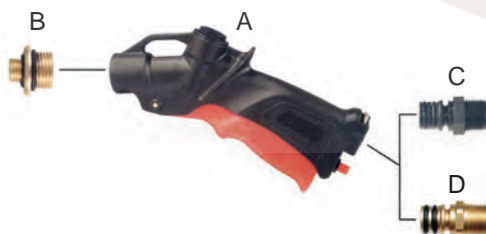

EMPUÑADURA REFORZADA CONFIGURABLE

CÓDIGO	DESCRIPCIÓN		P.V.P €
506.2600	EMPUÑADURA	A	11,36
506.2600.250	ADAPTADOR 3/8" M12x19	B	3,25
506.2600.150	RACOR GIRATORIO NYLON 1/2"	C	0,98
506.2400.101	RACOR GIRATORIO LATON 1/2"	D	5,31



LANZAS Y PISTOLAS PULVERIZACIÓN



CÓDIGO	DESCRIPCIÓN	P.V.P €
27.904.300	MODELO "LANZA LEVA M-27" C/BOQUILLA Ø 1,50 CERAMICA -LARGO 300 mm.	25,00
31.904.3	MODELO "MANOPLA M-31" C/BOQUILLA Ø 1,50 CERAMICA -LARGO 300 mm. DISPONIBLE HASTA FIN DE EXISTENCIAS	P.V.P. € NETO 6,25

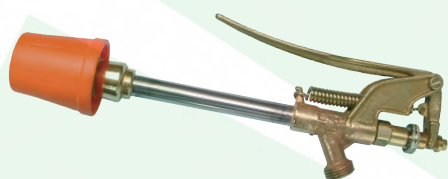

CÓDIGO	DESCRIPCIÓN	P.V.P €
109 017 4	LANZA LEVA "TURBINE 300" CON RACORD ENTRADA GIRATORIO M 1/2" Y BOQUILLA CERÁMICA 1,5	31,00



990990 00	LANZA LIGERA M31 CON CIERRE INDEPENDIENTE DE LA REGULACION. BOQUILLA CERAMICA Ø 1,5 mm Peso 527 g.	25,00
-----------	---	-------



010 023 00	PISTOLA "COMPACT - TURBO" C/BOQUILLA Ø 1,50	32,00
010 024 00	PISTOLA "COMPACT - REFORZADA" C/BOQUILLA Ø 1,50	36,00

ACCESORIOS

FIGURA	CÓDIGO	DESCRIPCIÓN	P.V.P €
	26.1502.45	RACOR GIRATORIO M-H 1/2" – LATÓN / INOX	9,35
	180205X	BOQUILLA CERAMICA Ø (1) (1,2) (1,5) (1,8) (2) (2,3) (2,5)	3,95
	162.604.810	RACOR C/TUERCA PLASTICA P/Ø 8-10	1,82



LANZAS HERBICIDAS / INSECTICIDAS / FUNGICIDAS - 20 bar



SALIDAS	ALARGOS	CÓDIGO	P.V.P. €
1 salida Cono	250 mm.	110 250 000	27,10
	500 mm.	110 500 000	31,60
	750 mm.	110 750 000	33,50
	1000 mm.	111 000 000	34,70
	Extensible	119 999 000	45,40



SALIDAS	ALARGOS	CÓDIGO	P.V.P. €
2 salidas Cono	250 mm.	120 250 000	33,20
	500 mm.	120 500 000	37,70
	750 mm.	120 750 000	39,50
	1000 mm.	121 000 000	40,80
	Extensible	129 999 000	51,50

SALIDAS	ALARGOS	CÓDIGO	P.V.P. €
3 salidas Cono	250 mm.	130 250 000	35,40
	500 mm.	130 500 000	38,60
	750 mm.	130 750 000	40,30
	1000 mm.	131 000 000	41,70
	Extensible	139 999 000	52,30

SALIDAS	ALARGOS	CÓDIGO	P.V.P. €
Con Campana y Boquilla abanico	250 mm.	190 250 000	28,30
	500 mm.	190 500 000	32,20
	750 mm.	190 750 000	34,00
	1000 mm.	191 000 000	35,30
	Extensible	199 999 000	46,00

Campana para herbicida con boquilla abanico Cod. 12003.1950	10,35
--	--------------

COMPONENTES

COD. 12009 +	DESCRIPCION	P.V.P.	COD. 12009 +	DESCRIPCION	P.V.P.
480214	EMPUÑADURA C/ GATILLO 12x19 F	16,90	12051	ALARGO 250 MM 12x19 M/H	6,35
2116112	JET CONO INOX 12x19	5,47	12052	ALARGO 500 MM 12x19 M/H	7,00
12011	CURVA 12x19 M/H SIN BOQUILLA	2,45	12053	ALARGO 750 MM 12x19 F	8,85
116012	BIFURCACION LANZA HERBICIDA	17,51	12054	ALARGO 1.000 MM 12x19 M/H	10,00
116013	TRIFURCACION LANZA HERBICIDA	22,90	120511	ALARGO EXTENSIBLE 550/1000 MM	21,40



LANZAS ALTA PRESIÓN

* LANZAS ROBUSTAS Y VERSÁTILES

* APTAS PARA TRATAMIENTOS DE MEDIO Y LARGO ALCANCE, LIMPIEZA AGRÍCOLA E INDUSTRIAL HASTA 60 ° Y APLICACIONES DE PROTECCIÓN CIVIL

* ÁNGULO DE CHORRO Y ALCANCE REGULABLE MEDIANTE LA MANCERA, QUE PUEDE ALMACENAR BOQUILLA DE RECAMBIO.

* RACOR ENTRADA 1/2" M

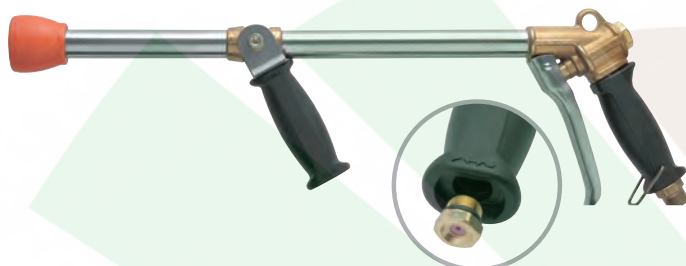

- MITRA -

Ø MÁX. BOQUILLA: 3,50
PRESION MÁX.: 60 bar
PESO: 1,5 kg
LONG.: 600 mm

STANDARD BOQUILLA: Ø 2,30 mm



CÓDIGO	P.V.P. €
--------	----------

12.7901.103	114,00
-------------	---------------



- LONG RANGE -

- LARGO ALCANCE -

Ø MÁX. BOQUILLA: 5,50
PRESION MÁX.: 60 bar
PESO: 1,6 kg
LONG.: 700 mm

STANDARD BOQUILLA: Ø 4,50 mm



CÓDIGO	P.V.P. €
--------	----------

12.13901.151	123,00
--------------	---------------



WASHING - ALTA PRESION

Ø MÁX BOQUILLA 2,3
PRESION MAXIMA 250 bar
CAUDAL MÁX EMPUÑADURA
30 l/mn
PESO 1,6 kg- LONG 720 mm

ESTÁNDAR BOQUILLA: Ø 1,5 (rosca M15x1)



CÓDIGO	P.V.P. €
--------	----------

12.22.901.161	147,00
---------------	---------------

12.22.1617.11	107,00
---------------	---------------



ESTÁNDAR BOQUILLA: Ø 1,5 (rosca M15x1)

SUBCONJUNTO SIN EMPUÑADURA NI BOQUILLA

entrada 1/4M para empuñadura
PA-ETL
22.1617.11



LANZAS ESPUMA INDUSTRIALES - Pres Max 250 bar

* USO EN SERVICIOS ANTIINCENDIOS - REGULADOR CENTRAL Y DIFUSOR CON SISTEMA VENTURI PARA PULVERIZAR AGUA O ESPUMÓGENO

FOAM MIX



CÓDIGO	P.V.P. €
3790120	264,00

STANDAR BOQUILLA LARGO
ALCANCE Ø 4,5 mm.
Empuñadura de seguridad norma ISO/EN
conexión 1/2" Macho
CAUDAL MÁXIMO EMPUÑADURA
50 l/mn
Distintas medidas de boquillas disponibles.
Peso 2 Kg - Largo 785 mm



FOAM MIX

SUB CONJUNTO FOAM MIX
STANDAR SIN BOQUILLA
CONEXION ENTRADA 1/4"
MACHO - CONEXION BOQUILLAS
M15X1
- Peso 1,2 Kg - Largo 580 mm

CÓDIGO	P.V.P. €
3716749	210,00

MULTIUSOS TRIPLE



CÓDIGO	P.V.P. €
80FAN000	255,00

MULTIUSOS RAPIDO INTERCAMBIO -
CABEZAL DE TRES BOQUILLAS
*CONO - *ABANICO - *ESPUMA -
CONEXIÓN ENTRADA 1/4 "

APLICACION EN ANTI-INCENDIOS QUE
PERMITE UTILIZAR LA MISMA LANZA
OPTIMIZANDO EL TIEMPO DE ACTUACIÓN.





CÓDIGO	P.V.P. €
80FAN008	212,00

SUBCONJUNTO TRIFASE COMPLETO
ENLACE RAPIDO
CONEXION RAPIDA 3/8 H



ABRAZADERAS - MADE IN SPAIN

	MEDI-DA	SIN FIN W1			€ LOTE		DOS OREJAS		
		UDS. BLISTER	€ BLISTER	UDS. LOTE			MEDIDA	€ BLISTER 10 unidades	€ LOTE 100 unidades
113008753	08-16	6	4,50	50	28,80	90661 0911 00	09/11	1,50	14,00
113008761	12-22	6	6,50	50	30,00	90661 1315 00	13/15	3,00	19,00
113008770	16-27	4	4,90	50	31,20	90661 1417 00	14/17	3,60	29,00
113008788	20-32	4	5,20	50	33,60	90661 1518 00	15/18	3,60	26,00
113008796	25-40	2	3,00	50	39,60	90661 1720 00	17/20		
113008809	30-45	2	3,00	50	39,60	90661 1821 00	18/21		29,00
113008817	32-50	2	3,30	50	42,00	90661 2023 00	20/23	4,80	32,00
113008825	40-60	2	3,60	25	24,00	90661 2225 00	22/25	4,80	34,00
113008833	50-70	-	-	25	30,00	90661 2528 00	25/28	4,80	40,00
113008841	60-80	-	-	25	32,40	90661 2831 00	28/31	5,20	43,00
						90661 3437 00	34/37	8,40	58,00

AÑADIR A CÓDIGO: **BL-BLISTER LO-LOTE**

AÑADIR A CÓDIGO: **BL-BLISTER LO-LOTE**

2022

ENROLLADORES DE MANGUERA



CÓDIGO	MODELO	CAPACIDAD	RACOR	PRESIÓN MAX.	P.V.P. €
220 2100	STAFFA 2000 Estructura robusta de acero barnizado resistente a rayos UV	100 m. tubo Ø 10x 18	Ø 8 y 10	50	150,00



OTROS MODELOS DISPONIBLES BAJO CONSULTA
- MANUALES - AUTOMATICOS ELECTRICOS E HIDRAULICOS - INOX, ETC



PISTOLAS DE TRASIEGO



506 530
PISTOLA DE TRASIEGO PARA
COMBUSTIBLES (Ø 19 mm.)

506 531
PISTOLA DE TRASIEGO PARA
COMBUSTIBLES (Ø 25 mm.)

P.V.P. 12,24 €

506 541
PISTOLA DE TRASIEGO PARA
LIQUIDOS
ALIMENTARIOS (Ø 25 mm.)
CUERPO DE POLIPROPILENO,
PARTES INTERIORES EN INOX

P.V.P. 17,31 €



CÓDIGO	DESCRIPCIÓN	F	F1	P.V.P. €
550 604	ADAPTADORES TANQUES INDUSTRIALES CUERPO PP- JUNTAS EPDM	1"		15,45
550 606		1" 1/2	S60 X 6	18,23
550 607		2"		19,36



LINEA RACORERIA BLANCA - NO ALIMENTARIA -PP Y NAYLON -
SOLICITEN INFORMACION DETALLADA ESPECIFICA

2022



MANGUERAS

- * Manguera PVC reforzada con tejido poliéster y capa intermedia adhesiva de PU
- * Indicada para pulverización agrícola y líquidos bajo presión.
- * Color NEGRO con franjas color según presión
- * Temperatura de uso -5°C +60°C. Rollos 100 m. ***



CÓDIGO	COLOR	d mm	D mm	Presión trabajo	presión rotura	P.V.P. €
950 210		8	13	20	60	1,50
950 220		10	14			1,65
950 230		13	19			2,50
950 410		8	14	40	120	1,54
950 420		10	16			2,10
950 430		13	21			4,35
1716 164	NEGRA	16	23			3,60
950 610*		8	15	80	240	2,80
950 620*		10	19			3,75
950 630*		13	23			5,25
950 640*	ROLLO 5 M	16	26			7,55



- * DOBLE CAPA POLIESTER Y PLASTIFICADO

MANGUERAS DE ASPIRACIÓN

- * Manguera PVC plastificado transparente con espiral de acero
- * Indicada para aspiración e impulsión de líquidos - * Flexible - Superficies lisas
- * Temperatura de uso -5°C +65°C.



CÓDIGO	d mm interior	D mm exterior	Rollos Mts***	P.V.P €
960 025	25	32	60	5,10
960 030	30	38	60	7,90
960 040	40	49	30	10,80
960 050	50	59	30	15,40

***Sobre coste manipulación metraje inferior 5 €

MANGUERA ESPIRAL

- *Espiral de PVC rígido *Protección tubos y agrupamiento mangueras contra aplastamiento y abrasión.



CODIGO	MEDIDAS	P.V.P. MTS.
970 013	13 X 16	3,20
970 020	20 X 25	4,45
970 025	25 X 30	6,50
970 044	44 X 50	10,65



CASCOS RESPIRADORES DE PROTECCIÓN

Funcionan mediante una ligera sobrepresión creada sobre el flujo del aire filtrado y depurado que la centralina envía a través del filtro dentro del casco.

- * Respiradores certificados según normas internacionales.
- * Ligeros y cómodos de uso.
- * Protección completa de vías respiratorias, cabeza, ojos, oídos y cuello.
- * Respiración confortable por la presión positiva al interior del casco.
- * Ajuste regulable sobre la cabeza con estudiada distribución del aire que no provoca molestias.
- * Accesorios posicionados en la cintura (excepto PROFF88).



CARACTERÍSTICAS TÉCNICAS:

- CASCO ligero de fibra de vidrio, color blanco.
- VISERA en policarbonato alta transparencia.
- RUMOROSIDAD < 75 dB
- PESO: aprox 900 gr.



K80S T9



K80S T8



PROFF 88



1301008



SP8

CÓDIGO	MODELO	P.V.P. €
14.313.215	T-9 Alimentación por batería tractor. Tensión 12 V Incluye: Filtro A2P3, cable SP9 y Accesorios.	545,00
14.313.219	T-9-R Alimentación por batería tractor. Tensión 12 V + BATERÍA INTERNA 1 h. Autonomía recargable a red eléctrica. Incluye Filtro A2P3, cable SP9, Cargador Z15 y Accesorios.	750,00
14.313.214	T-8-L8 Alimentación por batería de LITIO- AUTONOMÍA 8 h. Recargable a red eléctrica, tiempo máximo de recarga 11 h. Incluye 2 Filtros A2P3, Cargador LI-2 y Accesorios. OPCIÓN - ADAPTACIÓN T-8-BP A BATERÍA 12 V	825,00
07.309.170	Cable SP8 LI	69,50
07.1301.008	Base mechero universal	15,25
14.313.216	PROFF-88- CASO INTEGRAL CON MOTOR Y BATERÍA Alimentación por batería interna de LI-ION recargable a red eléctrica. AUTONOMÍA 8 h, tiempo de recarga 3 h. Incluye 2 Filtros A2P3, Cargador LI-2 y Accesorios. OPCIÓN - ADAPTACIÓN PROFF-88 A BATERÍA 12 V	855,00



MÁSCARAS DE PROTECCIÓN



VENUS

CÓDIGO	MODELO	P.V.P. €
14.1005.006	VENUS 1 - MÁSCARA PANORÁMICA SIN MOTOR - Ligera, peso inferior a 600 grs, baja resistencia respiratoria, sin distorsiones visuales, sistema antiempañamiento con válvulas. Incluye Filtro ZA2P3.	195,00



MÁSCARA ELIPSE CON FILTROS A1P3 -EN140: 1998

DISEÑO COMPACTO Y LIGERO QUE SE ADAPTA PERFECTAMENTE A LA CARA SIN INTERFERENCIA PARA OTRAS PROTECCIONES DE OJOS Y OÍDOS.

- * AMPLIA VÁLVULA CENTRAL ANTIRETORNO DE BAJA RESISTENCIA RESPIRATORIA QUE REDUCE AL MÍNIMO LA FORMACIÓN DE HUMEDAD AL INTERIOR DE LA MÁSCARA.
- * ABRAZADERA LIGERA Y ANTIDESLIZANTE FACILMENTE REGULABLE EN 4 POSICIONES
- * FILTROS DE ALTA EFICIENCIA DE CARBÓN ACTIVO CON FIELTRO HESPA® PLISADO
- * FABRICADO CON MATERIALES HIPOALÉRGICOS, INODOROS, SIN LÁTEX NI SILICONA
- * PESO MÁSCARA + FILTROS 257,7 g



CÓDIGO	MODELO	P.V.P. €
14007 SPR503	SEMI MÁSCARA ELIPSE C/FILTROS	40,00
07007 SPR341	FILTROS RECAMBIO A1P3 (PACK 2)	26,50

**CASCOS**

Casco - 0302037

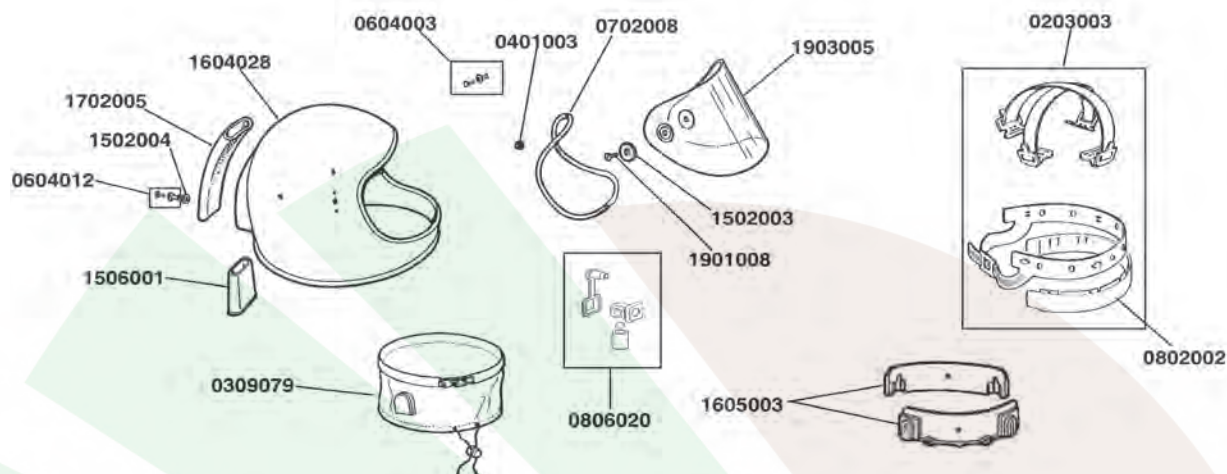
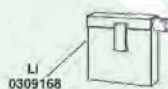
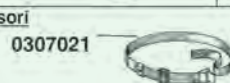
**0313214 K80S T8****0313215 K80S T9**CentralinaBateríaCentralinaBateríaLI
0309168CaricabateríaCavoCaricabateríaCavoFiltroTuboFiltroTuboAccesoriosAccesorios**0313216 PROF 88**

Casco - 0302038

REPUESTOS PRINCIPALES

CÓDIGO	DESCRIPCIÓN	P.V.P. €
1502003	ARANDELA	3,10
1901008	TORNILLO	1,25
1903005	VISERA K80S	44,15
0303006	CENTRALINA T-9	225,00
0309079	COLLAR COMPLETO	59,00
0309081	CABLE	22,00
0309109	TUBO	44,10
0309168	BATERÍA LI	316,00
0702008	JUNTA	10,20
0806020	AIREADOR	10,16

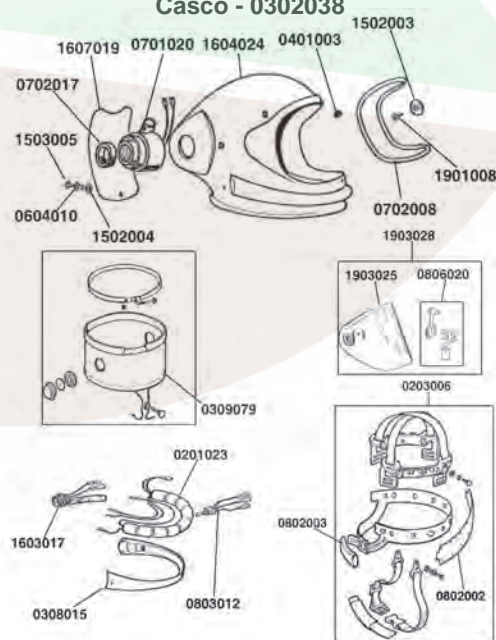

02.22

 I.V.A. PORTES y EMBALAJES A PARTE
 Reservado el derecho de modificar sin previo
 aviso, características, modelos y precios



FILTROS DE ALTA CALIDAD DE DIÁMETRO AMPLIADO (110 mm)
-CERTIFICADOS "CE"-
ROSCA Y COLORES UNIFICADOS SEGÚN NORMAS
EN148/1 – EN14387 – EN143.2000

REJILLA DE PROTECCIÓN ORIENTABLE PARA UNA RÁPIDA DESCONTAMINACIÓN, AÚN BAJO LA DUCHA

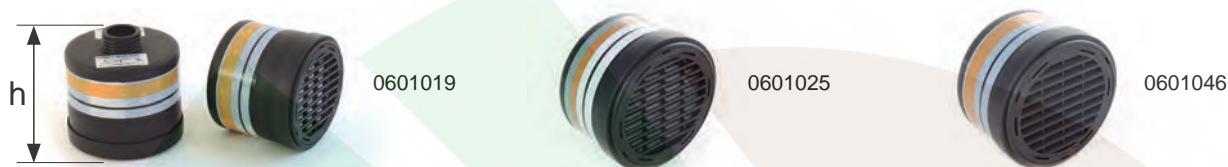

CÓDIGO	TIPO	COLOR	APLICACIÓN	T9 T8	PROFF VENUS	P.V.P. €
07.601.019	ZA2P3 h 116	CAFÉ / BLANCO	VAPORES ORGANICOS + POLVO	✓	-	39,00
07.601.023	ZP3 h 55	BLANCO	POLVO	✓	✓	25,00
07.601.025	ZA2B2P3 h 91	CAFÉ / BLANCO / GRIS	VAPORES ORGÁNICOS E INORGÁNICOS + GASES ÁCIDOS + POLVO	✓	-	45,00
07.601.046	ZA2P3 h 91	CAFÉ / BLANCO	VAPORES ORGANICOS + POLVO	-	✓	35,00
07.601.049	ZA2BEKP3 h 91	CAFÉ / BLANCO / GRIS / AMARILLO / VERDE	VAPORES ORGÁNICOS, GASES ÁCIDOS, VAPORES INORGÁNICOS, ANHÍDRIDO SULFUROSO Y AMONIACOS	✓	✓	54,00

TRAJE DE PROTECCIÓN PARA SUSTANCIAS NO PELIGROSAS

- * Polietileno no-tejido y microperforado, color Gris.
- * Fuerte, ligero y resistente a pinchazos y desgarros.
- * Confortable, permite el paso de aire y del vapor de agua.
- * Reutilizable muchas veces y lavable hasta 7 veces.
- * Costuras cosidas, cremallera y solapa de nylon.
- * Elásticos en puños y espalda, pernera abierta y 2 bolsillos.



CÓDIGO	TALLA	P.V.P. €
07.170.501	XL – (54-56)	
07.170.502	XXL – (58)	

KIT BÁSICO DE PROTECCIÓN

- * Mono TYVEK transpirable con capucha y cierre rápido con cremallera.
- * Delantal PVC / Poliester muy resistente.
- * Gafas con lentes antivaho.
- * Dos Mascarillas antidisolventes con capa de carbón activo.
- * Dos parejas de guantes de nitrilo afelpados internamente.

CÓDIGO	P.V.P. €
925 000	77,91





1. GENERALIDADES

Estas condiciones generales de venta se consideran aceptadas por el comprador al momento de efectuar un pedido y no anulan cualquier otra condición de venta especial pactada por escrito que se considerará condición particular para ese pedido. INTERAGRI S.A. para evitar cualquier agravio comparativo aplicará estas condiciones de venta con toda seriedad y rigor, descartando cualquier trato preferencial.

Esta Tarifa ANULA LAS ANTERIORES.

2. MATERIALES

Las imágenes y datos incluidos en esta Tarifa son ilustrativos e informativos, pudiendo ser modificados por variaciones introducidas por los fabricantes y/o errores de impresión.

3. PRECIOS

Los precios son válidos salvo error de impresión y están expresados en € euros y no incluyen PORTES, EMBALAJES NI I.V.A.

INTERAGRI.S.A. se reserva el derecho de modificación sin previo aviso.

4. ENVÍOS

Las mercancías viajan por cuenta y riesgo del comprador. Pedido mínimo - 30 euros neto material

Los envíos se efectuarán por el medio que ordene el cliente, a portes debidos.

Sin instrucciones expresas, y en base a los convenios preferenciales de INTERAGRI S.A. con las agencias de transporte los envíos se efectuarán a portes pagados y repercutidos en factura por el medio más rápido y económico atendiendo las mejores condiciones para el Cliente.

5. PEDIDOS

Serán efectuados haciendo constar los códigos incluidos en este catálogo y respetando las unidades por envase en los artículos que así vengan indicados. INTERAGRI S.A. declina toda responsabilidad por incidencias sobre pedidos que no observen estas condiciones y se reserva la posibilidad de modificar las condiciones de descuentos estipuladas en suministros por debajo del lote establecido.

6 RECEPCION Y DEVOLUCIONES

El comprador tiene la obligación de revisar la mercancía a su recepción.

Eventuales incidencias deben ser comunicadas en un plazo máximo de 8 días.

No se admitirá ningún cambio o devolución que no haya sido previamente autorizado, siempre libre de portes y se aplicará un demérito MÍNIMO del 10% en concepto de gastos de gestión. En ningún caso se aceptarán devoluciones de material descatalogado o superados los tres meses de su adquisición. No se aceptará ninguna devolución no autorizada y/o que no venga acompañada de albarán detallado de material devuelto e indicaciones pertinentes.

7. PAGOS

Se efectuarán en forma, procedimiento y plazo indicado en factura, siempre de acuerdo a la legislación vigente. Toda devolución y/o retraso bloqueará la operativa y devengará gastos e intereses de mora que deberán ser asumidos por el comprador.

6. GARANTÍAS

Todos nuestros materiales están garantizados contra todo defecto de fabricación por un plazo de 12 meses a partir de la fecha de entrega y cubre única y exclusivamente la sustitución de la pieza defectuosa una vez recibida y según dictamen técnico. En ningún caso se extiende la garantía sobre otros daños que hayan podido producirse directa o indirectamente.

La modificación, manipulación y/o uso inadecuado de cualquier pieza provoca la pérdida total de posible Garantía

7. LITIGIO

Para todo litigio serán únicamente competentes los Tribunales de Lleida, renunciando el comprador a cualquier otro fuero que pudiera corresponderle.

ESTE CATALOGO/TARIFA ES PROPIEDAD DE INTERAGRI S.A, INCLUYE IMÁGENES Y MENCIÓN A MARCAS REGISTRADAS PROPIEDAD DE TERCEROS. NO PUEDE SER REPRODUCIDO TOTAL O PARCIALMENTE SIN PREVIA PETICION ESCRITA Y AUTORIZACION, EXPRESA.

SERAN EJERCIDAS LAS ACCIONES O PROCEDIMIENTOS LEGALES PERTINENTES EN DEFENSA DE LA PROPIEDAD INTELECTUAL QUE CORRESPONDA.

INTERAGRI S.A. - FEBRERO 2022 -



www.interagri.es



Carretera Nacional 230, km. 5,6 - 25196 LLEIDA (Spain) - P.O. Box 642 - 25080 LLEIDA (Spain)
Tel (+34) 973 221 077 / (+34) 973 221 477
www.interagri.es - e-mail: interagri@interagri.es